

User Manual



WCA330 & WCA380 3GHz & 8GHz Wireless Communication Analyzer 070-A792-50

This document applies to firmware version 3.2 and above.

www.tektronix.com

Copyright © Tektronix Japan, Ltd. All rights reserved.

Copyright © Tektronix, Inc. All rights reserved.

Tektronix products are covered by U.S. and foreign patents, issued and pending. Information in this publication supercedes that in all previously published material. Specifications and price change privileges reserved.

Tektronix Japan, Ltd., 5-9-31 Kitashinagawa, Shinagawa-ku, Tokyo 141-0001 Japan

Tektronix, Inc., P.O. Box 500, Beaverton, OR 97077

TEKTRONIX and TEK are registered trademarks of Tektronix, Inc.

WARRANTY

Tektronix warrants that the products that it manufactures and sells will be free from defects in materials and workmanship for a period of one (1) year from the date of shipment. If a product proves defective during this warranty period, Tektronix, at its option, either will repair the defective product without charge for parts and labor, or will provide a replacement in exchange for the defective product.

In order to obtain service under this warranty, Customer must notify Tektronix of the defect before the expiration of the warranty period and make suitable arrangements for the performance of service. Customer shall be responsible for packaging and shipping the defective product to the service center designated by Tektronix, with shipping charges prepaid. Tektronix shall pay for the return of the product to Customer if the shipment is to a location within the country in which the Tektronix service center is located. Customer shall be responsible for paying all shipping charges, duties, taxes, and any other charges for products returned to any other locations.

This warranty shall not apply to any defect, failure or damage caused by improper use or improper or inadequate maintenance and care. Tektronix shall not be obligated to furnish service under this warranty a) to repair damage resulting from attempts by personnel other than Tektronix representatives to install, repair or service the product; b) to repair damage resulting from improper use or connection to incompatible equipment; c) to repair any damage or malfunction caused by the use of non-Tektronix supplies; or d) to service a product that has been modified or integrated with other products when the effect of such modification or integration increases the time or difficulty of servicing the product.

THIS WARRANTY IS GIVEN BY TEKTRONIX IN LIEU OF ANY OTHER WARRANTIES, EXPRESS OR IMPLIED. TEKTRONIX AND ITS VENDORS DISCLAIM ANY IMPLIED WARRANTIES OF MERCHANTABILITY OR FITNESS FOR A PARTICULAR PURPOSE. TEKTRONIX' RESPONSIBILITY TO REPAIR OR REPLACE DEFECTIVE PRODUCTS IS THE SOLE AND EXCLUSIVE REMEDY PROVIDED TO THE CUSTOMER FOR BREACH OF THIS WARRANTY. TEKTRONIX AND ITS VENDORS WILL NOT BE LIABLE FOR ANY INDIRECT, SPECIAL, INCIDENTAL, OR CONSEQUENTIAL DAMAGES IRRESPECTIVE OF WHETHER TEKTRONIX OR THE VENDOR HAS ADVANCE NOTICE OF THE POSSIBILITY OF SUCH DAMAGES.

Service Options

Tektronix provides service to cover repair under warranty as well as other services that are designed to meet your specific service needs. Advancing technology has brought incredible change to the power of measurement instruments. Manufacturing methods and calibration techniques have been revolutionized, making the service challenge tougher than ever. By using Tektronix as your service provider you make use of our technology and product knowledge, our world-wide logistics infrastructure, and our ISO9000 approved service centers. Tektronix technicians are trained on the latest products and are equipped with the most current information on product improvements and upgrades for optimum product performance.

Warranty Repair Service. Tektronix technicians provide warranty service at most Tektronix service locations worldwide. The warranty period for this product can be found behind the title page in this manual.

Calibration and Repair Service. Tektronix offers calibrations, non-warranty repair, and support for customers performing their own service. Where appropriate, calibrations are compliant to ANSI/NCSL Z-540/ISO GUIDE 25 and ISO9000 Quality Systems. If you prefer to perform your own service, Tektronix supports repair to the replaceable-part level through providing for circuit board exchange. All services can be purchased through a variety of agreements to fit your specific requirements.

For more information, regarding service offerings or service locations worldwide, please see the Tektronix product catalog or visit us on our Customer Services World Center web site at:

<http://www.tek.com/Measurement/Service>.

Table of Contents

General Safety Summary	xv
Service Safety Summary	xvii
Preface	xix
About This Manual	xix
Related Documents	xx
Conventions	xx
Contacting Tektronix	xxi

Getting Started

Product Overview	1-1
Features	1-2
Targets	1-3
Difference between WCA330 and WCA380	1-3
Architecture	1-4
Installation and Power On	1-9
Unpacking and Inspection	1-9
Connecting the Power Cord	1-10
Powering On	1-11
Adjusting the Display Tilt Angle	1-15
Powering Off	1-16
When the Analyzer Does Not Seem to Work Properly	1-17
Backing Up User Files	1-18
About Installation of Other Applications	1-18
Calibration and Diagnostics	1-19
Calibration	1-20
Diagnostics	1-23
Characteristics Check	1-25

Operating Basics

Interface Maps	2-1
Front Panel	2-2
Rear Panel	2-4
Display Screen Configuration	2-5
General Display Information in a View	2-6
Status and Setup Display	2-7
Menu Operations	2-11
Displaying Menus	2-11
Menu Item Information	2-14
Selection and Numeric Input	2-16

Tutorial	2-19
Preparations	2-20
Connecting the Signal Generator	2-20
Applying Power	2-21
Configuring the Analyzer with Basic Configuration Patterns	2-23
Measuring a Digitally-Modulated Signal	2-26
Changing Hardware Settings	2-28
View Definitions and Layout	2-33
Averaging and Compared Display	2-38
Peak Search and Zoom	2-40
Delta Markers	2-43
Turning Off the Power	2-46
Menu Functions	2-47
Setup Sequence	2-47
CONFIG Menu	2-48
SETUP (Standard) Menu	2-54
SETUP (CDMA) Menu	2-59
SETUP (3gppACP) Menu	2-61
Waveform View Menu	2-63
Analog View Menu	2-69
FSK View Menu	2-71
Spectrogram View Menu	2-72
Waterfall View Menu	2-75
Polar View Menu	2-76
EyeDiagram View Menu	2-79
SymbolTable View Menu	2-80
EVM View Menu	2-81
CDMAWaveform View Menu	2-83
CDMAPolar View Menu	2-86
CDMATime View Menu	2-88
CodeSpectrogram View Menu	2-90
CodePolar View Menu	2-92
CodePower View Menu	2-93
CodeWSpectrogram View Menu	2-95
CodeWPolar View Menu	2-97
CodeWPower View Menu	2-99
3gppACPView Menu	2-100
3gppSpectrogram View Menu	2-103
3gppPolar View Menu	2-104
3gppPower View Menu	2-106
GSM View Menu	2-107
GSM Polar View Menu	2-108
GSM Mask View Menu	2-111
CCDF Menu	2-112
CCDFView Menu	2-114
AutoSave Menu	2-115
SelfCal (Util A) Menu	2-116
SaveLoad (Util B) Menu	2-117
Average (Util C) Menu	2-118
File Access Menu	2-119
Print Menu	2-120
Changing the Power-Up Settings	2-121

Reference

Input and Memory Modes	3-1
Selecting the Input Frequency Band	3-2
Selecting the IF Mode	3-4
Memory Modes: Scalar, Frequency, Dual, and Zoom	3-5
Setting the Mode	3-6
Mode Summary	3-7
Frequency and Span	3-9
Setting Frequency and Span	3-9
Setting the Frequency with the Marker and Search	3-11
Buffering the Input Value	3-11
Reference Level	3-13
Setting the Reference Level	3-13
Overload	3-14
FFT Parameters	3-15
FFT Type	3-16
FFT Points	3-16
FFT Window	3-17
Setting FFT Parameters	3-19
Acquiring Data	3-21
Roll Mode and Block Mode	3-21
Setting the Block Size	3-22
Starting/Stopping Data Acquisition	3-23
Frame Period and Real Time	3-25
Setting a Frame Period	3-25
Frame Period and Seamless Acquisition	3-26
Real-Time Acquisition	3-26
Displaying Waveform Data	3-31
Setting Views	3-32
Setting Scales	3-36
Changing Display Frames	3-38
Relation among Frame, Bin, and Pixel	3-41
Marker Operations and Peak Search	3-45
Type of Marker	3-45
Moving the Primary Marker	3-46
Operating the Delta Marker	3-48
Zoom	3-51
Zoom Process	3-52
Zoom Range	3-53
Zoom Operation	3-54
Average and Peak Hold	3-57
Averaging Process	3-58
Averaging Mode	3-60
Operating Example of the View Average Function	3-61
Operating Example of the Utility Average Function	3-63

Trigger	3-65
Setting a Trigger	3-66
Creating a Trigger Mask Pattern	3-75
Hints for Creating a Mask Pattern	3-76
Example of Creating a Mask Pattern	3-77
Power Measurement	3-81
Setting Requirements	3-82
Noise Measurement	3-83
Power Measurement	3-84
C/N and C/No Measurements	3-85
ACP Measurement	3-86
OBW Measurement	3-88
Band Power Marker Operations	3-90
Analyzing an Analog Modulated Signal	3-95
Setting	3-95
Display	3-96
Display and Analysis of a Digitally-Modulated Signal	3-97
Process Flow	3-98
Supported Modulation Systems	3-98
Setting	3-100
Vector and Constellation Displays	3-102
Eye Diagram Display	3-104
Symbol Table Display	3-105
Error Vector Analysis Display	3-106
Analyzing an FSK Digital Modulated Signal	3-109
Setting	3-109
Display	3-110
CDMA Analysis	3-111
Evaluation of Demodulation Precision and Waveform Quality	3-112
Evaluation of Spurious	3-116
Time Characteristic Evaluation	3-122
cdmaOne Analysis	3-127
About cdmaOne Analysis	3-128
Operating Examples	3-129
W-CDMA Analysis	3-135
About W-CDMA Analysis	3-135
Operating Examples	3-137
3GPP Analysis	3-143
3GPP Down-Link Signal Analysis	3-143
3GPP ACP Measurement	3-149
GSM Analysis	3-151
Measurement Functions	3-152
Basic Operations	3-154
Entering the Sync Word	3-163
CCDF Analysis	3-165
About CCDF Analysis	3-166
Operating Examples	3-167

Auto-Save Function	3-169
Restrictions	3-169
Operating Procedure	3-170
Loading the Data	3-172
File Operations	3-173
Saving and Loading Files	3-174
Operating File Access Menu	3-178
Data File Format	3-184
Data Block	3-189
Correction Data Block	3-194
Using Windows 98	3-195
Attaching a Mouse and a Keyboard	3-195
Accessing Windows 98	3-197
LAN Connection	3-199
Attaching a Cable	3-199
Network Setting	3-200
Sharing Resources	3-200
Outputting Waveform Data	3-201
Screen Hardcopy	3-202
Outputting View Data in Text Format	3-206
Setting the Date and Time	3-209
Displaying the Version and Self Test Result	3-211

Appendices

Appendix A: Options and Accessories	A-1
Options	A-1
Standard Accessories	A-2
Optional Accessories	A-2
Appendix B: Specifications	B-1
Electrical Characteristics	B-2
Physical Characteristics	B-12
Environmental Characteristics	B-12
Appendix C: Default Settings	C-1
Restoring Default Settings	C-9
Appendix D: Frequency and Time Resolution	D-1
Appendix E: Mouse Operations	E-1
Displaying the Front Panel Interface	E-2
Mouse Operations	E-3
Operations with Keyboard	E-9
Caution in Turning Off the Power	E-9
Appendix F: Inspection and Cleaning	F-1
Inspection and Cleaning Procedures	F-1

Index

List of Figures

Figure 1–1: WCA330/WCA380 wireless communication analyzer ..	1–1
Figure 1–2: Signal processing system block diagram	1–4
Figure 1–3: AC inlet on the rear panel	1–10
Figure 1–4: Mouse connector location (rear panel)	1–11
Figure 1–5: Principal power switch on the rear panel	1–12
Figure 1–6: Power switch (ON/STANDBY)	1–12
Figure 1–7: New clock settings dialog box	1–13
Figure 1–8: Display of self test results upon power-up (upper left of screen)	1–13
Figure 1–9: Initial screen	1–14
Figure 1–10: Angular adjustment of tilt display	1–15
Figure 1–11: Displaying UNCAL	1–20
Figure 1–12: Running the self gain-calibration	1–21
Figure 1–13: Running calibration and diagnostics	1–22
Figure 1–14: Execution results of diagnostic routines (View C)	1–25
Figure 2–1: Front panel map (left part)	2–2
Figure 2–2: Front panel map (right part)	2–3
Figure 2–3: Rear panel map	2–4
Figure 2–4: Display screen configuration	2–5
Figure 2–5: View general display information	2–6
Figure 2–6: Status display areas	2–7
Figure 2–7: Setup display area	2–9
Figure 2–8: Menu display area and keys	2–11
Figure 2–9: CONFIG menu keys	2–12
Figure 2–10: SETUP menu keys	2–12
Figure 2–11: VIEW keys	2–13
Figure 2–12: Examples of top menu item display	2–14
Figure 2–13: Examples of lower menu item display	2–15
Figure 2–14: Menu items requiring selection or numeric input	2–16
Figure 2–15: Drop-down list for selecting an item	2–16
Figure 2–16: Side menu item for numeric setting	2–17
Figure 2–17: Step keys	2–18
Figure 2–18: Increment display	2–18
Figure 2–19: Cable connection	2–20

Figure 2–20: Power switch	2–21
Figure 2–21: Initial screen	2–22
Figure 2–22: CONFIG:MODE key and the menu	2–23
Figure 2–23: Control of the start and stop of measurement	2–24
Figure 2–24: Spectrum measurement with a span of 3 GHz	2–24
Figure 2–25: Status display area	2–25
Figure 2–26: Four-view display for digital modulation analysis	2–26
Figure 2–27: Measuring the digitally-modulated signal – Span 3 GHz	2–27
Figure 2–28: SETUP:FREQ key location	2–28
Figure 2–29: Freq side menu item available for numeric input	2–29
Figure 2–30: Numeric input keypad	2–29
Figure 2–31: Span side menu item available for numeric input	2–30
Figure 2–32: Setup display areas	2–31
Figure 2–33: Views resulting from changes to the frequency and span settings	2–32
Figure 2–34: CONFIG:VIEW key and its submenu	2–33
Figure 2–35: Selecting the Waterfall view	2–34
Figure 2–36: Making changes to View D	2–35
Figure 2–37: Four-view display layout	2–36
Figure 2–38: VIEW keys (view control keys)	2–36
Figure 2–39: View B display (1-view display)	2–37
Figure 2–40: Averaging and compared waveform display	2–39
Figure 2–41: Signal acquisition in the Zoom mode	2–41
Figure 2–42: Example of zooming	2–42
Figure 2–43: Moving the markers by peak search	2–43
Figure 2–44: Measurement example using the delta markers	2–45
Figure 2–45: Signal process and display blocks	2–47
Figure 2–46: Frame Relative On and Off	2–68
Figure 2–47: Separation setting	2–68
Figure 2–48: Setting Mask Percent for the EVM calculation	2–82
Figure 2–49: Setting the receive filter with the ACP... submenu	2–102
Figure 2–50: Setting the sync word parameters	2–110
Figure 3–1: Signal process flow	3–2
Figure 3–2: Usage of data memory	3–5
Figure 3–3: SETUP keys for setting the frequency and span	3–9
Figure 3–4: Relationship between the frequency and span settings ..	3–12
Figure 3–5: SETUP keys for setting reference level	3–13

Figure 3–6: Overload indicator	3–14
Figure 3–7: Window process of time domain data	3–17
Figure 3–8: Roll mode and Block mode	3–21
Figure 3–9: Relationship between the block size and frames	3–22
Figure 3–10: ROLL key and BLOCK key	3–23
Figure 3–11: Frame period	3–25
Figure 3–12: Seamless status display	3–26
Figure 3–13: Seamless acquisition and real-time acquisition	3–27
Figure 3–14: Real-time acquisition in the frequency domain	3–28
Figure 3–15: View control keys	3–32
Figure 3–16: Views A to H (2x2 display)	3–32
Figure 3–17: One-view display	3–34
Figure 3–18: Two-view display	3–34
Figure 3–19: Four-view display (1x4 display)	3–35
Figure 3–20: Four-view display (2x2 display)	3–35
Figure 3–21: Setting scales	3–36
Figure 3–22: Display frames	3–38
Figure 3–23: Linked views example	3–40
Figure 3–24: Relationship among frame, bin, and pixel	3–42
Figure 3–25: Display data compression method	3–43
Figure 3–26: Marker read-out	3–46
Figure 3–27: Zoom process	3–52
Figure 3–28: Spectra before and after zooming	3–55
Figure 3–29: Averaging process in the view	3–58
Figure 3–30: Process of the utility average	3–59
Figure 3–31: Simultaneous display of a spectrum and its averaged waveform (Example)	3–61
Figure 3–32: Acquiring and displaying data in the Auto and Normal modes	3–66
Figure 3–33: Delayed trigger	3–67
Figure 3–34: Timeout trigger	3–67
Figure 3–35: Interval trigger	3–68
Figure 3–36: Quick trigger	3–68
Figure 3–37: Quick Interval trigger	3–69
Figure 3–38: Three-dimensional view display effect by setting a trigger count	3–71
Figure 3–39: Relation between the trigger count and the frame	3–72
Figure 3–40: Trigger position and data acquisition	3–74
Figure 3–41: Example of a trigger mask pattern	3–75

Figure 3-42: Example of a trigger mask pattern with a shifted baseline	3-79
Figure 3-43: Noise measurement example	3-83
Figure 3-44: Power measurement example	3-84
Figure 3-45: C/N and C/No measurement examples	3-85
Figure 3-46: ACP measurement example	3-87
Figure 3-47: OBW measurement example	3-89
Figure 3-48: Power measurement band power marker	3-90
Figure 3-49: ACP measurement band power marker	3-91
Figure 3-50: Band power marker used for the OBW measurement ..	3-93
Figure 3-51: Display examples of analog signal demodulation	3-96
Figure 3-52: Digital modulation signal flow	3-99
Figure 3-53: Vector and constellation display examples	3-102
Figure 3-54: Vector and Eye diagram display examples	3-104
Figure 3-55: Symbol table display example	3-105
Figure 3-56: EVM view display examples	3-106
Figure 3-57: 1/4 π QPSK constellation display example and error vector	3-107
Figure 3-58: Example display of FSK modulation signal demodulation	3-110
Figure 3-59: CDMA analysis with the EVM/Rho basic configuration	3-112
Figure 3-60: CDMA analysis with the Spurious basic configuration (30 MHz span)	3-116
Figure 3-61: CDMA analysis with the Spurious basic configuration (5 MHz span)	3-118
Figure 3-62: Default specified line (when RBW = 30 k)	3-119
Figure 3-63: Default specified line (when RBW = 1 M)	3-119
Figure 3-64: CDMA analysis with the Time Domain basic configuration	3-122
Figure 3-65: Default mask area	3-123
Figure 3-66: Analyzing rising and falling characteristics in detail ..	3-125
Figure 3-67: Code-domain power spectrogram	3-130
Figure 3-68: Constellation	3-130
Figure 3-69: Code-domain power	3-131
Figure 3-70: Analyzing a transient signal	3-133
Figure 3-71: Code-domain power spectrogram	3-138
Figure 3-72: Symbol constellation	3-138
Figure 3-73: Code-domain power	3-139
Figure 3-74: Symbol power	3-139

Figure 3–75: Analyzing a transient signal	3–141
Figure 3–76: Code-domain power spectrogram	3–147
Figure 3–77: Symbol constellation	3–147
Figure 3–78: Code-domain power	3–148
Figure 3–79: Symbol power	3–148
Figure 3–80: 3GPP ACP measurement example	3–150
Figure 3–81: Slot data structure	3–152
Figure 3–82: Modulation accuracy measurement	3–155
Figure 3–83: Output power measurement	3–156
Figure 3–84: Power vs. Time measurement	3–157
Figure 3–85: Spectrum (MOD) measurement	3–159
Figure 3–86: Spectrum (SW) measurement	3–161
Figure 3–87: Entering a sync word in the GSMPolar view	3–163
Figure 3–88: CCDF calculation process	3–166
Figure 3–89: CCDF measurement (View G)	3–168
Figure 3–90: CCDFView display (View H)	3–168
Figure 3–91: Auto-save views in two modes (View C and D)	3–171
Figure 3–92: Automatic data storage in the Roll mode	3–172
Figure 3–93: Side keys to display the file access menu	3–178
Figure 3–94: Directory and file listings in the file access menu	3–178
Figure 3–95: File operation menu	3–179
Figure 3–96: Copying a file	3–181
Figure 3–97: Data file structure	3–184
Figure 3–98: Frame padding	3–187
Figure 3–99: Data block structure	3–189
Figure 3–100: Mouse and keyboard connectors	3–195
Figure 3–101: Displaying the Windows 98 accessory menu	3–197
Figure 3–102: 10/100 BASE-T connector location (rear panel)	3–199
Figure 3–103: Setting for sharing a folder	3–200
Figure 3–104: Parallel port location (rear panel)	3–202
Figure 3–105: Installing the printer driver	3–203
Figure 3–106: Pasting text data of the spectrum	3–207
Figure 3–107: Creating a graph from the text data in Excel	3–208
Figure 3–108: Date/Time Properties dialog box	3–209
Figure 3–109: Displaying the version and self test result (view of upper left corner)	3–211
Figure E–1: Front panel interface for mouse operations	E–1

Figure E-2: Correspondence between front panel interface buttons and front panel keys	E-4
Figure E-3: Operating the side menu (top level item)	E-5
Figure E-4: Operating the side menu (7 items in lower level)	E-6
Figure E-5: Selecting menus using the mouse	E-7
Figure E-6: Moving the marker and selecting a frame	E-8

List of Tables

Table 1–1: Internal diagnostic program	1–23
Table 2–1: Status display	2–8
Table 2–2: Setup display items	2–10
Table 2–3: CONFIG menu table	2–48
Table 2–4: SETUP (standard) menu table	2–54
Table 2–5: SETUP (CDMA) menu table	2–59
Table 2–6: SETUP (3gppACP) menu table	2–61
Table 2–7: Waveform view menu table	2–63
Table 2–8: Analog view menu table	2–69
Table 2–9: FSK view menu table	2–71
Table 2–10: Spectrogram view menu table	2–72
Table 2–11: Waterfall view menu table	2–75
Table 2–12: Polar view menu table	2–76
Table 2–13: EyeDiagram view menu table	2–79
Table 2–14: SymbolTable view menu table	2–80
Table 2–15: EVM view menu table	2–81
Table 2–16: CDMAWaveform view menu table	2–83
Table 2–17: CDMAPolar view menu table	2–86
Table 2–18: CDMATime view menu table	2–88
Table 2–19: CodeSpectrogram view menu table	2–91
Table 2–20: CodePolar view menu table	2–92
Table 2–21: CodePower view menu table	2–93
Table 2–22: CodeWSpectrogram view menu table	2–96
Table 2–23: CodeWPolar view menu table	2–97
Table 2–24: CodeWPower view menu table	2–99
Table 2–25: 3gppACPView menu table	2–100
Table 2–26: 3gppPolar view menu table	2–104
Table 2–27: GSM view menu table	2–107
Table 2–28: GSMPolar view menu table	2–108
Table 2–29: GSMMask menu table	2–111
Table 2–30: CCDF menu table	2–113
Table 2–31: CCDFView menu table	2–114
Table 2–32: AutoSave menu table	2–115
Table 2–33: SelfCal menu table	2–116

Table 2–34: SaveLoad menu table	2–117
Table 2–35: Average menu table	2–118
Table 2–36: File Access menu table	2–119
Table 2–37: Print menu table	2–120
Table 3–1: Input frequency band	3–2
Table 3–2: IF modes	3–4
Table 3–3: Mode summary	3–7
Table 3–4: Frequency and span setting range	3–10
Table 3–5: Reference level setting range	3–13
Table 3–6: Input modes and FFT parameters	3–16
Table 3–7: FFT window and band-pass filter	3–18
Table 3–8: Block size setting range	3–22
Table 3–9: Minimum frame period	3–29
Table 3–10: The number of bins	3–41
Table 3–11: Zoom range	3–53
Table 3–12: Maximum trigger count	3–70
Table 3–13: Modulating systems	3–98
Table 3–14: CDMA analysis items	3–111
Table 3–15: cdmaOne parameters	3–128
Table 3–16: W-CDMA parameters	3–135
Table 3–17: 3GPP parameters	3–143
Table 3–18: GSM measurement functions	3–152
Table 3–19: Files available in the analyzer	3–174
Table 3–20: Data format available in views	3–176
Table 3–21: Possible combinations of data types	3–190
Table 3–22: Frame size	3–191
Table 3–23: Order of bins in frequency domain	3–191
Table 3–24: Functions available with a keyboard	3–196
Table A–1: Options	A–1
Table A–2: Standard accessories	A–2
Table A–3: Optional accessories	A–2
Table B–1: Frequency	B–2
Table B–2: Spectrum purity	B–2
Table B–3: Input	B–3
Table B–4: Reference level	B–3
Table B–5: Dynamic range	B–4

Table B–6: Spurious response (Typical)	B–4
Table B–7: Acquisition	B–5
Table B–8: Sampling rate	B–6
Table B–9: Frame update time	B–7
Table B–10: Digital demodulation	B–8
Table B–11: Analog demodulation accuracy (Typical)	B–8
Table B–12: Resolution bandwidth filter	B–9
Table B–13: Trigger	B–9
Table B–14: Display	B–10
Table B–15: Marker	B–10
Table B–16: Zoom	B–11
Table B–17: Controller/Interface	B–11
Table B–18: Power requirements	B–11
Table B–19: Physical	B–12
Table B–20: Environmental	B–12
Table B–21: Certifications and compliances	B–13
Table C–1: Default settings for the Standard configuration	C–1
Table C–2: Default settings for the CDMA configuration	C–4
Table C–3: Default settings for the 3GPP configuration	C–6
Table D–1: Frequency and time resolution – IF mode: Normal, HiRes	D–1
Table D–2: Frequency and time resolution – IF mode: Wide 1	D–2
Table E–1: Mapping between keypad and keyboard keys	E–9
Table F–1: External inspection check list	F–2

General Safety Summary

Review the following safety precautions to avoid injury and prevent damage to this product or any products connected to it. To avoid potential hazards, use this product only as specified.

Only qualified personnel should perform service procedures.

To Avoid Fire or Personal Injury

Use Proper Power Cord. Use only the power cord specified for this product and certified for the country of use.

Ground the Product. This product is grounded through the grounding conductor of the power cord. To avoid electric shock, the grounding conductor must be connected to earth ground. Before making connections to the input or output terminals of the product, ensure that the product is properly grounded.

Observe All Terminal Ratings. To avoid fire or shock hazard, observe all ratings and markings on the product. Consult the product manual for further ratings information before making connections to the product.

Do Not Operate Without Covers. Do not operate this product with covers or panels removed.

Avoid Exposed Circuitry. Do not touch exposed connections and components when power is present.

Do Not Operate With Suspected Failures. If you suspect there is damage to this product, have it inspected by qualified service personnel.

Do Not Operate in Wet/Damp Conditions.

Do Not Operate in an Explosive Atmosphere.

Provide Proper Ventilation. Refer to the manual's installation instructions for details on installing the product so it has proper ventilation.

Observe Standard Precautions for Lifting Heavy Objects. The product weighs more than 30 kg. To avoid falling or injury, carry the product with two or more people.

Symbols and Terms

Terms in this Manual. These terms may appear in this manual:



WARNING. *Warning statements identify conditions or practices that could result in injury or loss of life.*



CAUTION. *Caution statements identify conditions or practices that could result in damage to this product or other property.*

Terms on the Product. These terms may appear on the product:

DANGER indicates an injury hazard immediately accessible as you read the marking.

WARNING indicates an injury hazard not immediately accessible as you read the marking.

CAUTION indicates a hazard to property including the product.

Symbols on the Product. The following symbols may appear on the product:



WARNING
High Voltage



Protective Ground
(Earth) Terminal



CAUTION
Refer to Manual

Service Safety Summary

Only qualified personnel should perform service procedures. Read this *Service Safety Summary* and the *General Safety Summary* before performing any service procedures.

Do Not Service Alone. Do not perform internal service or adjustments of this product unless another person capable of rendering first aid and resuscitation is present.

Disconnect Power. To avoid electric shock, disconnect the mains power by means of the power cord or, if provided, the power switch.

Use Care When Servicing With Power On. Dangerous voltages or currents may exist in this product. Disconnect power, remove battery (if applicable), and disconnect test leads before removing protective panels, soldering, or replacing components.

To avoid electric shock, do not touch exposed connections.

Preface

About This Manual

This user manual is for the WCA330 and WCA380 Wireless Communication Analyzers.

This manual consists of the following sections:

- *Getting Started* contains the product overview and describes the architecture, installation, and calibration of the analyzer.
- *Operating Basics* explains the functions of the front and rear panels and menu items of the analyzer, and describes the basic menu operations. This section also provides the tutorials for beginners. It gives step-by-step procedures for measurement using a signal generator.
- *Reference* explains the basic concepts of measurement processes and application-specific operations. It also gives the combined procedures of the front panel keys and menu operations.
- *Appendix* explains the accessories, specifications, default settings, mouse/keyboard operations, and how to clean the analyzer.

First time users should complete the installation as described in *Getting Started*, then go to *Operating Basics* and perform the procedures shown in *Tutorial* beginning on Page 2-19.

The analyzer uses Windows 98 as the operating system. This manual does not describe common use of Windows 98. Refer to your Windows 98 manuals as necessary.

Related Documents

In addition to this user manual, the following documentation is available for your analyzer:

- *WCA330 and WCA380 Programmer Manual* (070-A794-XX, standard accessory) explains how to use the script language and how to use GPIB commands. The script language allows you to allocate a custom function to a menu key of the analyzer and perform automatic measurement. GPIB commands allow you to control the instrument from a PC remotely.
- *WCA330 and WCA380 Service Manual* (070-A795-XX, optional accessory) describes how to verify the characteristics of, adjust, disassemble, assemble, and troubleshoot the analyzer, and contains the information required for repair, including module replacement, and calibration.

Conventions

This manual uses the following conventions:

- Front-panel button and control labels are printed in the manual in upper case text. For example, ROLL, BLOCK, PRINT. If it is part of a procedure, the button or control label is printed in boldface. For example:

Press **BLOCK**.

- To easily find buttons on the front panel, the area name label is printed together with the button by concatenating with a colon (:), as in SETUP:MAIN, VIEW:SCALE, etc. For example:

Press the CONFIG:MODE key.

- Menu and on-screen form titles are printed in the manual in the same case (initial capitals) as they appear on the analyzer screen. For example, Source, Format. If it is part of a procedure, the menu title is shown in boldface. For example:

Press the **Trigger...** side key.

- A list of keys, controls, and/or menu items separated by an arrow symbol (→) indicates the order in which to perform the listed tasks. For example:

Select CONFIG:MODE → **More...** → CDMA → **Spurious**.

Contacting Tektronix

Phone	1-800-833-9200*
Address	Tektronix, Inc. Department or name (if known) 14200 SW Karl Braun Drive P.O. Box 500 Beaverton, OR 97077 USA
Web site	www.tektronix.com
Sales support	1-800-833-9200, select option 1*
Service support	1-800-833-9200, select option 2*
Technical support	Email: support@tektronix.com 1-800-833-9200, select option 3* 1-503-627-2400 6:00 a.m. – 5:00 p.m. Pacific time

* **This phone number is toll free in North America. After office hours, please leave a voice mail message. Outside North America, contact a Tektronix sales office or distributor; see the Tektronix web site for a list of offices.**

Getting Started

Product Overview

WCA330 and WCA380 are wireless communication analyzers equipped with a 3 GHz/8 GHz down-converter to analyze Radio Frequency (RF) signals. The newly adopted architecture allows concurrent acquisition of time and frequency domain data and display of measurement results in color. The analyzer provides a wide variety of functions such as spectrum, power, analog and digital modulation, and CDMA analyses. The instrument is shown in Figure 1-1.

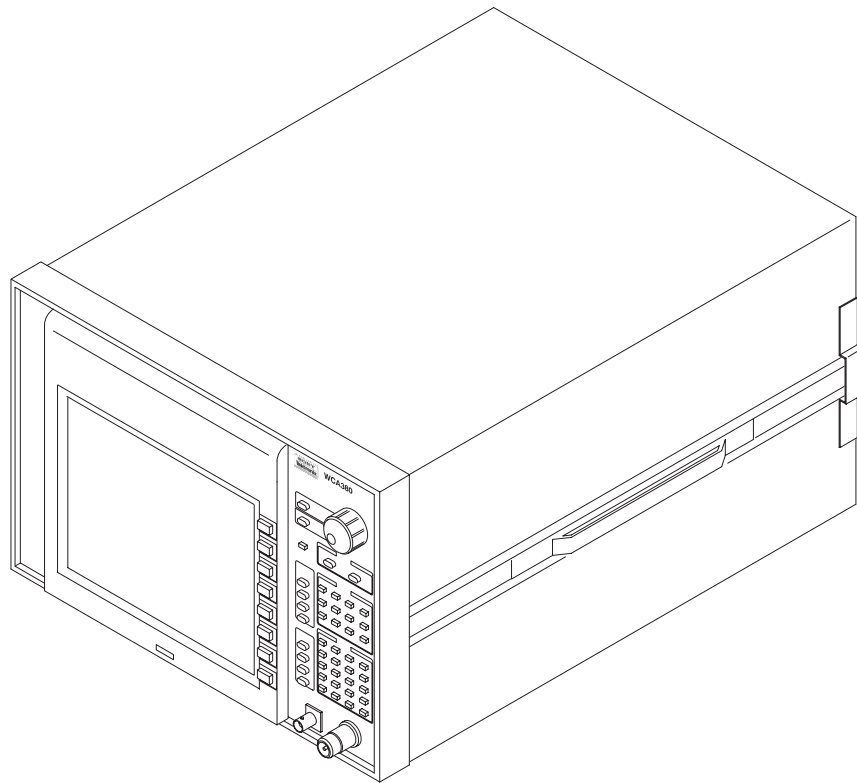

Figure 1-1: WCA330/WCA380 wireless communication analyzer

Features

The analyzer has the following features:

- Measurement frequency range:
DC to 3 GHz for the WCA330
DC to 8 GHz for the WCA380
- Measurement span: 100 Hz to 3 GHz
- Concurrent processing of real-time frequency and modulation analysis
- Digital zoom function (2 to 1000-times expansion of frequency)
- Concurrent analysis and display of frequency and time domain data
- Abundant trigger functions: frequency mask, level, and external triggers
- Power analysis: noise, power, C/N, C/No, ACP, and OBW
- Digitally-modulated signal analysis (Maximum span of 30 MHz)
- CDMA analysis (IS-95 standard)
- Ability to display 17 types of analysis results:
 - Spectrum display (frequency vs. level or phase)
 - Spectrogram display (frequency vs. level, or phase vs. time)
 - Waterfall display (time vs. modulation factor, phase or frequency)
 - Analog demodulation display
(time vs. modulation factor, phase or frequency)
 - FSK demodulation view (time vs. frequency)
 - Constellation/vector display (digital demodulation)
 - EYE diagram display
 - Symbol table display
 - EVM/Rho analysis display (IS-95 standard)
 - Spurious analysis display (IS-95 standard)
 - Time characteristics analysis display (IS-95 standard)
 - Code domain power (W-CDMA standard)
 - Time vs. channel power (W-CDMA standard)
 - Code domain power spectrum (W-CDMA standard)
 - ACP measurement (W-CDMA standard)
 - CCDF display
 - CCDF measurement display
- 12.1 inch, full-color TFT display and sturdy cabinet

Targets

The analyzer is capable of real-time analysis for the following usages:

- Power measurement: Power, noise, C/N, ACP, and OBW
- W-CDMA (3GPP): Code domain power, EVM, and ACP
- CDMA (IS-95): Rho, spurious characteristics, and time characteristics
- CCDF measurement
- Digital modulation analysis
- Analog modulation analysis
- Variation analysis in PLL frequency:
 - Jitter in reference oscillator of a mobile phone
 - localization of a radio set
 - Hard disk read-out jitter
- Analysis of momentary noise:
 - Mixed noise measurement
 - EMI measurement
- Multi-path measurement: Measurement of electric wave environment
- Electric wave interference: Radar interference
- Electric wave analysis: Analyzing electric wave from foreign countries

Difference between WCA330 and WCA380

WCA330 and WCA380 have the same functions except for their measurement frequency ranges:

WCA330 DC to 3 GHz

WCA380 DC to 8 GHz

The descriptions in this manual apply to both the WCA330 and the WCA380, unless otherwise noted.

Architecture

Figure 1–2 contains the signal processing system block diagram for the analyzer.

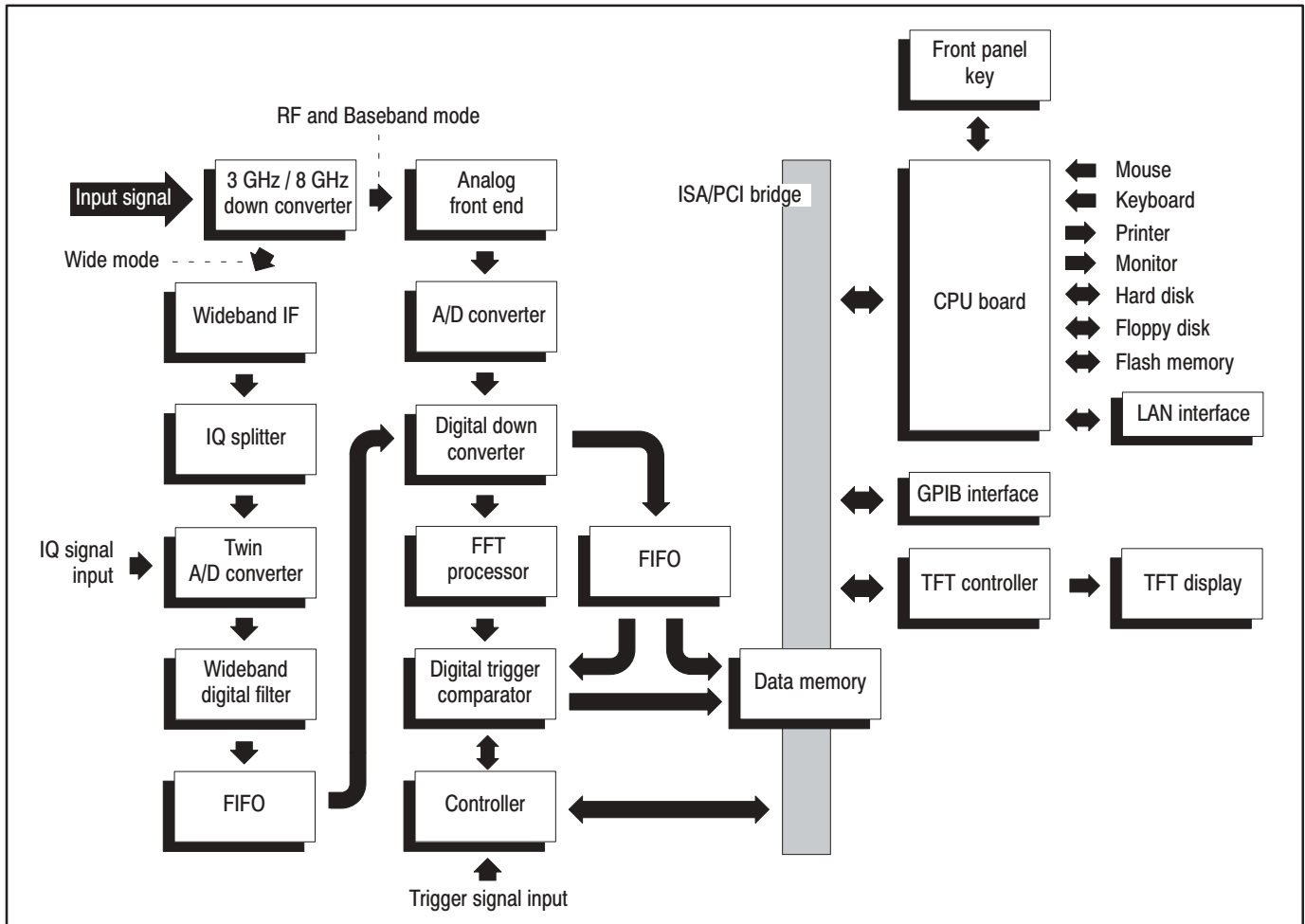

Figure 1–2: Signal processing system block diagram

3 GHz / 8 GHz Down Converter	Converts the RF signal, input at the front-panel RF INPUT, into a 10 MHz IF signal. The bandwidth is 3 GHz for the WCA330 and 8 GHz for the WCA380. The signal output from the down converter is sent to the succeeding block, i.e., analog front end. The down converter is equipped with the voltage reference and reference clock generator at the periphery.
Wideband IF	Amplifies and filters the IF signal converted through the down converter with the wideband amplifier that implements the maximum span of 30 MHz without scanning. The input signal goes through this block in the Wide IF mode.
IQ Splitter	Splits the signal processed in the wideband IF block to the I and Q components. Also, you can input the I and Q signals directly from the rear panel connectors.
Twin A/D Converter	Converts the analog I and Q signals separated by the IQ splitter to the digital quantity, respectively.
Wideband Digital Filter	Thins out the sampling clock to change the span.
FIFO	Stores the data from the wideband digital filter and outputs them to the digital down converter, synchronizing with the data stream from the analog front end.
Analog Front End	Conditions the signal for A/D conversion by using the low-noise amplifier and high-precision attenuator, and anti-aliasing filter. The input signal goes through this block in the RF and Baseband mode.
A/D Converter	The output from the analog front end block enters the A/D converter via the fine-tuning attenuator, the anti-aliasing filter, and the driver amplifier. The sampling rate of this converter is 25.6 MHz, and its resolution is 14 bits. The A/D converter is equipped with the offset-regulating D/A converter, voltage reference, and reference clock generator at the periphery.

Digital Down Converter

Performs span and center frequency setting, which are required for flexible spectrum analysis. This converter consists of two main stages. The first stage converts the 0 to 10 MHz real signal into the complex signal of ± 5 MHz. The second stage converts the frequency to set any center frequency.

A thinning-out filter is provided between stages to implement span changes by thinning out the sampling rate. This filter consists of an FIR filter of a maximum of 503 taps and four-stage comb filters. The factor of the FIR filter can be set at a high precision of 20 bits, and it implements relatively sharp thinning-out filtering with less spurious emission.

FIFO

Upon receiving the data stream from the digital down converter, this block divides the data into frames, and writes the data into data memory. The FIFO sends these frames to the digital trigger comparator at the same time.

FFT Processor

Performs 1,024- or 256-point complex FFT at high speed. This block consists of the FFT calculation DSP, output buffer, and timing control circuit. To obtain the capability of performing 1,024-point complex FFT at 12,500 times/s, this processor has a unique parallel structure. This capability of calculation enables real-time analysis to be available in up to 5 MHz span.

The input data is subjected to a window process to keep from missing parts of the spectrum. For the window type, you have three options of Blackman-Harris, Hamming, and Rectangular. To guarantee the continuity of data, the windows show view of the spectrum span which overlap by 50% or more for real-time spans of 5 MHz or less.

Digital Trigger Comparator

This block has the real-time digital trigger mechanism to monitor the occurrence of a specific event on the spectrum. Trigger conditions are produced by editing a mask pattern on the amplitude vs. frequency display screen. The mask pattern can be obtained also by making changes to acquired data.

Since the trigger comparator is continuously in operation at the maximum rate, the phenomenon will not be missed even when a low rate of frame update has been set in the Block mode. The pre-trigger and post-trigger positions can be set optionally; the phenomenon before and after the trigger event can be measured.

- Data Memory** This is a 16 Mbyte, high-rate SRAM block that stores spectrum data. For 1,024-point analysis, this memory contains 4,000 frames; for 256-point analysis, it contains 16,000 frames. The memory is accessed from the system controller via the ISA/PC bridge.
- Controller** Controls the signal processing system hardware.
- ISA/PCI Bus** The ISA/PCI bus links the system components.
- CPU Board** This system controller board is equipped with a Intel CELERON CPU. It controls the analyzer hardware and the user interface with the Windows 98 operating system. The analyzer is equipped with a 40 G-byte hard disk and a 3.5 inch floppy disk drive for storing data and settings, 8 M-byte flash disk for storing calibration data, and expansion slots.
- The analyzer has the following external interfaces on the rear panel:
- Mouse
 - Keyboard
 - Centronics parallel
 - VGA output
 - LAN Ethernet (10/100BASE-T)
 - GPIB
- TFT Display** A 12.1 inch XGA TFT-LCD module is used. This color display has a sufficient resolution for multi-windows, and can display 17 formats. You can select up to eight formats and display four of them together.

Installation and Power On

Before beginning the installation, be sure to read *General Safety Summary* and *Service Safety Summary* starting on page xv.

This section describes the following procedures:

- Unpacking and inspection
- Connecting the power cord
- Powering on
- Adjusting the display tilt angle
- Powering off
- Resetting the analyzer
- Backing up user files

Unpacking and Inspection



CAUTION. *This product weighs about 31 kg. To avoid falling or injury, carry the product with two or more people.*

1. This product is packed in a corrugated fiberboard container for delivery. Before opening the container, be sure to check that it has no scratches or damage on its surface.
2. When opening the container, check that the product has no damage and that all the standard accessories are found inside. For a list of accessories, refer to *Standard Accessories* on page A-2. If you find any damaged or missing components, contact your local Tektronix representatives.
3. It is recommended that the container and packing materials be stored in a safe place. The container and packaging material should be used to transport this product for calibration or repair.



CAUTION. *The analyzer has two exhaust fans on the rear panel. Leave a clearance of at least 5 cm at both sides for proper air circulation.*

Connecting the Power Cord

1. Plug in the power cord to the AC inlet on the rear panel. Refer to Figure 1–3.

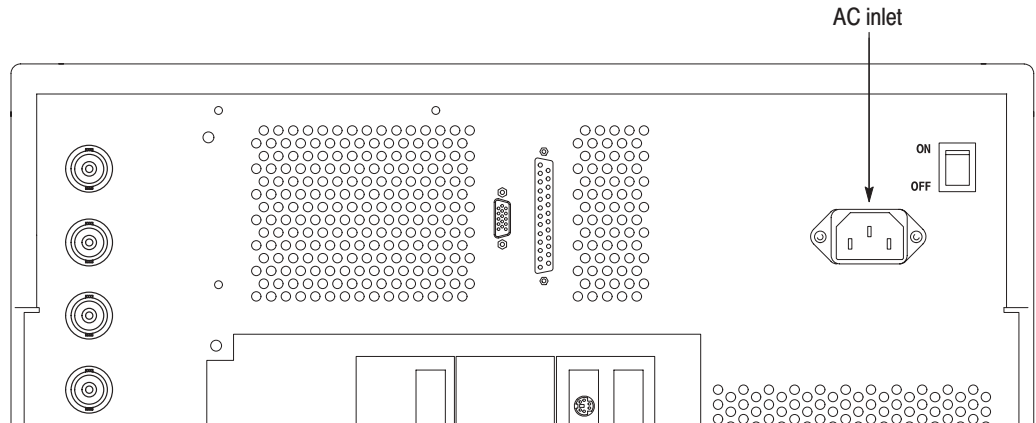

Figure 1-3: AC inlet on the rear panel



CAUTION. *The analyzer operates at a power supply voltage of 90 V to 250 V and a power supply frequency of 47 Hz to 66 Hz. Before plugging the cord into the outlet, make sure that your power supply is suitable for the analyzer.*

2. Plug the power cord into a three-wired outlet that has a protective ground line.

The metallic section on the surface of the analyzer is connected to a power supply protective ground terminal through a power cord ground line. To prevent electrical shocks, insert the plug into an outlet that has a protective ground line.

Powering On

Connecting the Mouse

Connect the standard mouse to the rear panel connector before turning the analyzer power on (see Figure 1-4).



CAUTION. To avoid damaging the analyzer, make sure that the power is off before connecting the mouse. If the power is on, turn off the Power Switch on the front panel and wait until the power shuts off completely.

For the normal analyzer operation, the mouse is not necessary. You can use it in these cases:

- When you want to operate with a mouse instead of the front panel. Refer to Appendix E for the mouse operations.
- When Windows 98 displays a dialog box for maintaining the operating system (for example, changing the time).

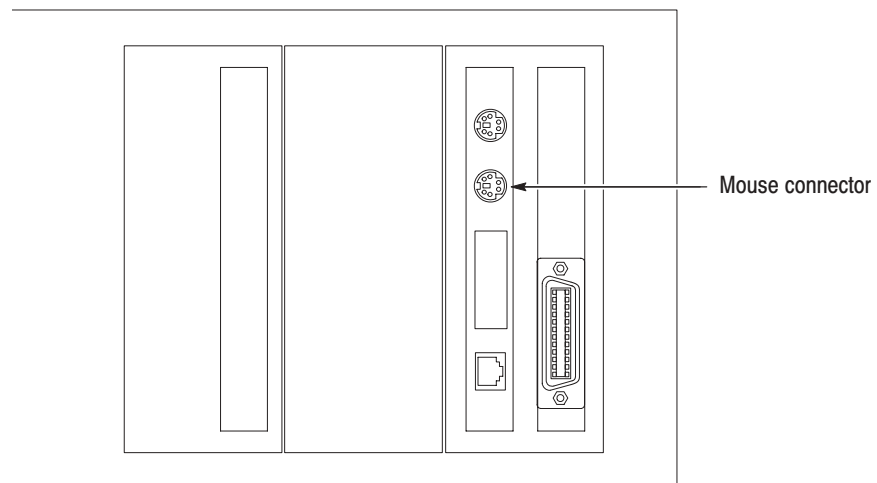

Figure 1-4: Mouse connector location (rear panel)

Turning On the Power 1. Turn on the principal power switch on the rear panel. See Figure 1-5.

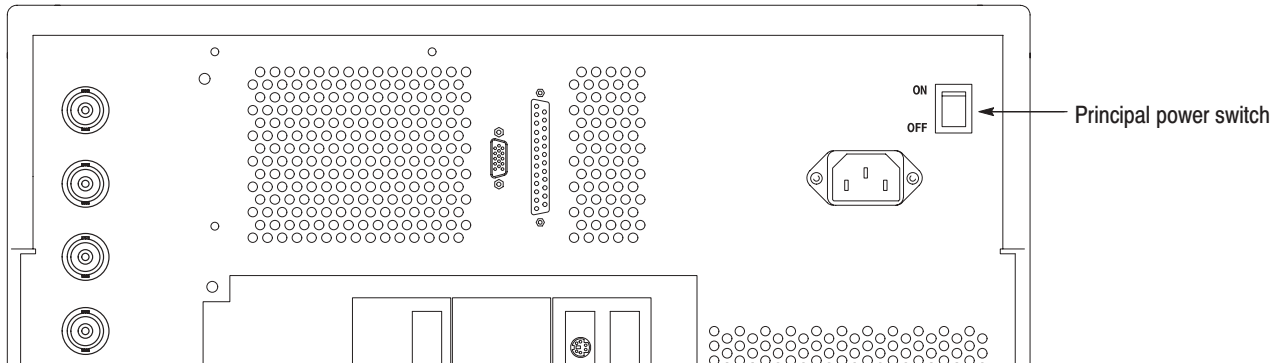

Figure 1-5: Principal power switch on the rear panel

When you turn on the principal power switch, a voltage is placed on the standby circuit in the analyzer. Make sure that the **STANDBY LED** is lit.

2. Turn **ON** the switch (**ON/STANDBY**) located at the bottom left corner of the front panel. See Figure 1-6.

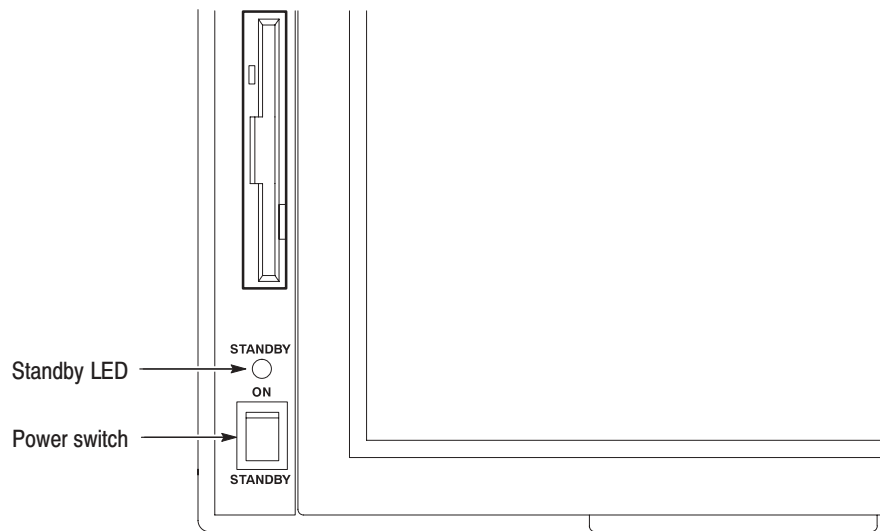

Figure 1-6: Power switch (ON/STANDBY)

When you power on the analyzer, Windows 98 is booted and then applications are started. The **STANDBY LED** goes out after blinking for a while.

When the New clock settings dialog box appears. If Windows 98 displays the “New clock settings” dialog box at power-on (see Figure 1–7), press the **OK** button with the mouse to start the analyzer application.

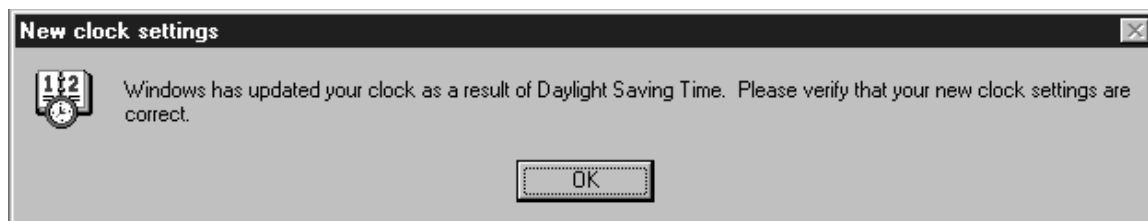

Figure 1–7: New clock settings dialog box

For the date and time setting procedure, refer to page 3–209.

Self Test. When you turn on the power, the analyzer performs a pass/fail test for ROM and RAM using an internal diagnosis routine and checks whether the A20 (Digital Down Converter) board is installed. Upon completion, it displays the result as shown in Figure 1–8. When “Fail” or “Not installed” is displayed, contact your local Tektronix representatives.

```
WCA380 WIRELESS COMMUNICATION ANALYZER
Copyright (C) 2000 SONY/TEKTRONIX CORPORATION

Main System:
Version:          3.11

Sub System:
Version:          4.1
Rom:              Pass
Ram:              Pass
A20:              Installed

Options:
```

Figure 1–8: Display of self test results upon power-up (upper left of screen)

The following initial screen appears, as shown in Figure 1-9.

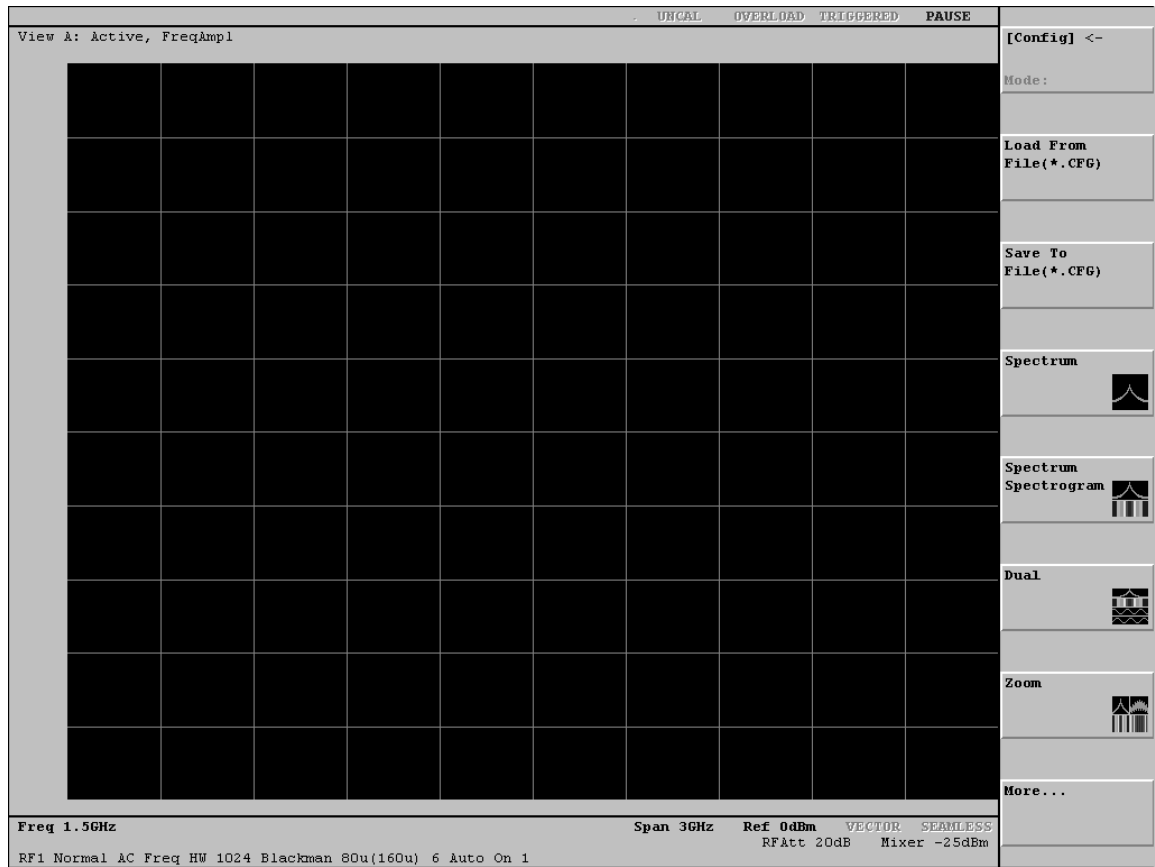

Figure 1-9: Initial screen

Adjusting the Display Tilt Angle

You can adjust the tilt angle of the display within the range of 0 to 30 degrees as appropriate to the lighting conditions in the room and the level of your eyes.

When you press the release bar at the bottom of the display, the bottom of the display slightly pops up toward you. While holding the display at its bottom, pull it up toward you until you find the optimal viewing angle.

If you want to return the display into the main cabinet, continue to press the bottom of the display until you hear a click. See Figure 1–10.

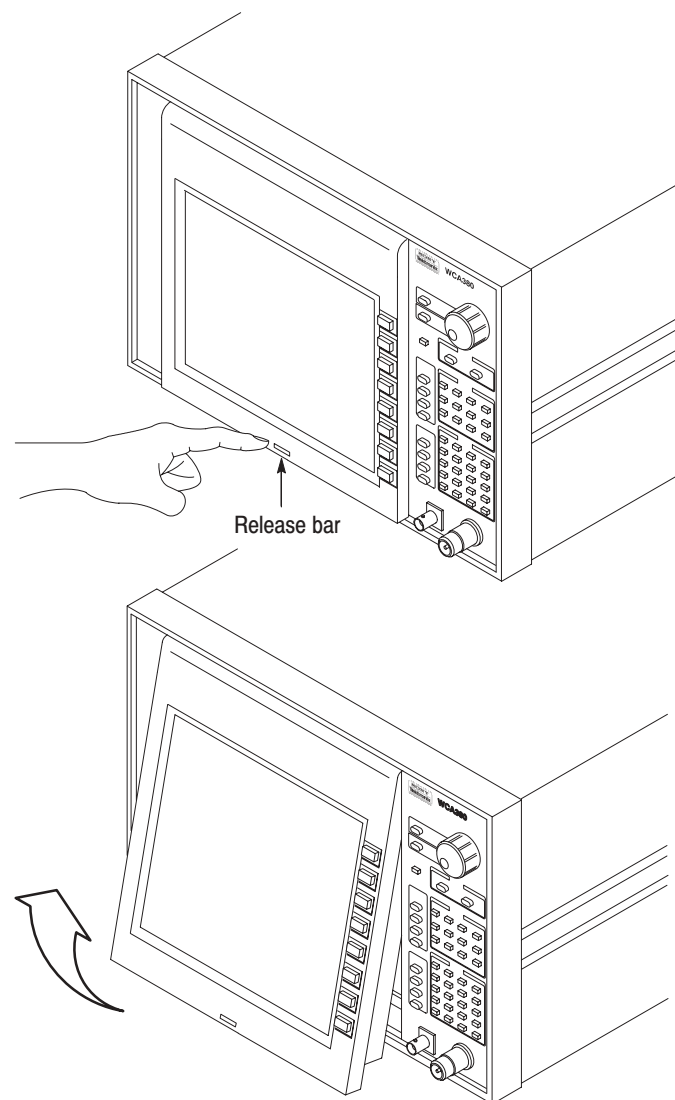

Figure 1-10: Angular adjustment of tilt display

Powering Off

Place the power switch on the front panel in the **STANDBY** position.

When you place the power switch in the STANDBY position, the internal software detects the condition of the power switch, terminates measurement applications and Windows 98 and automatically powers off the analyzer. You do not have to terminate them manually. The STANDBY LED is lit after blinking for a while.

NOTE. *When you place the power switch on the front panel in the STANDBY position, the principal power supply is not turned off completely. When you want to turn off the principal power supply, you must place the principal power switch on the rear panel in the OFF position.*



CAUTION. *When you powering on or off the analyzer, be sure to use the power switch on the front panel. When the power cord remains unplugged from the AC outlet, or no voltage is being supplied to the AC outlet, be sure to keep the power switch in the STANDBY position.*

When the Analyzer Does Not Seem to Work Properly

When the analyzer does not seem to work properly, use the following procedure to power off the analyzer and power on again.

NOTE. *When the analyzer does not work properly, power is not shut off by returning the power switch on the front panel from ON to STANDBY.*

1. Make sure that the power switch on the front panel is in the **STANDBY** position.
2. Place the principal power switch on the rear panel in the **OFF** position.
3. 10 seconds later, place the principal power switch on the rear panel in the **ON** position.
4. Place the power switch on the front panel in the **ON** position.

When Scan Disk Appears

If the analyzer was not shut down properly, the Windows Scan Disk may be executed when you power it on. When the Scan Disk screen appears, perform the following procedure:

1. Perform either of the following:
 - Wait for about one minute with the Scan Disk screen displayed.
 - Attach a keyboard to the analyzer and press any key.

Scan Disk continues to run.

2. If no error is detected, applications on the analyzer are started.

If an error is detected, refer to an appropriate Windows manual. For how to access Windows on the analyzer, refer to *Using Windows 98* on page 3–195.

Backing Up User Files

You should back up your user files on a regular basis as an insurance against system failures. The Back Up tool is located in the System Tool folder in the Accessories folder. Start this tool to select files and folders to be backed up. Use the Windows on-line help for information on using the Back Up tool. For how to access Windows on the analyzer, refer to *Using Windows 98* on page 3–195.

In particular, you should back up user-generated files frequently. User-generated files consist of configuration and data files with the following extensions:

- Configuration files: .CFG and .TRG
- Data files: .AP, .IQ, .APT, and .IQT

Using LAN

The analyzer is equipped with the standard LAN Ethernet interface, allowing you to save data in peripheral devices such as PCs, hard disks, or MO via network.

For how to connect the analyzer to LAN, refer to page 3–199.

About Installation of Other Applications

The analyzer incorporates Windows 98 as the operating system. Some combinations of internal measurement applications and external applications may cause degradation in the basic performance and contention among these applications. It is not recommended that you install other applications including Internet Explorer, Word, and Excel on the analyzer. If you do so, you must keep this in mind.

Calibration and Diagnostics

To guarantee the basic operations of the analyzer, perform the following:

- Calibration
 - Self gain-calibration
 - IQ offset calibration
 - Wide IQ balance calibration
 - Wide IQ full calibration
- Diagnostics
- Characteristic checks

When an error occurs during above process, contact your local Tektronix representative.

Calibration

Self Gain-Calibration

This internal calibration routine calibrates the amplifier gain based on an internal signal generator. This routine should be run when you boot the analyzer or when UNCAL (uncalibrated) is displayed during operation.

Allow the analyzer to warm up for 20 minutes before you begin the calibration procedure. The warm-up period allows electrical performance of the analyzer to stabilize.

During normal operation, when the ambient temperature changes by more than $\pm 5^\circ \text{C}$ from the temperature at the previous calibration, UNCAL is displayed in red in the hardware status display area (see Figure 1–11). Run the self gain-calibration.

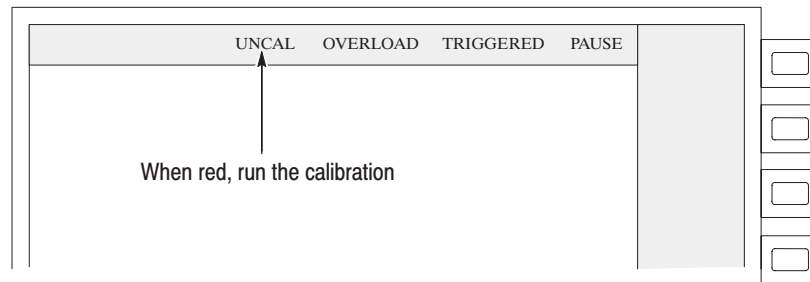

Figure 1-11: Displaying UNCAL

Use the following procedure to perform self gain-calibration.

NOTE. When you run self gain-calibration during signal acquisition, calibration begins after the acquisition is completed.

1. Press the **UTILITY** key in the front panel **CONFIG** area. See Figure 1–12.
2. Press the **Util A [SelfCal]** side key.
3. Press the **Gain Cal** side key.

The calibration runs. It takes several seconds to complete the process.

4. If you press the **AutoGainCal** side key to select **On**, calibration will run automatically anytime the analyzer gain drifts to an UNCAL state.

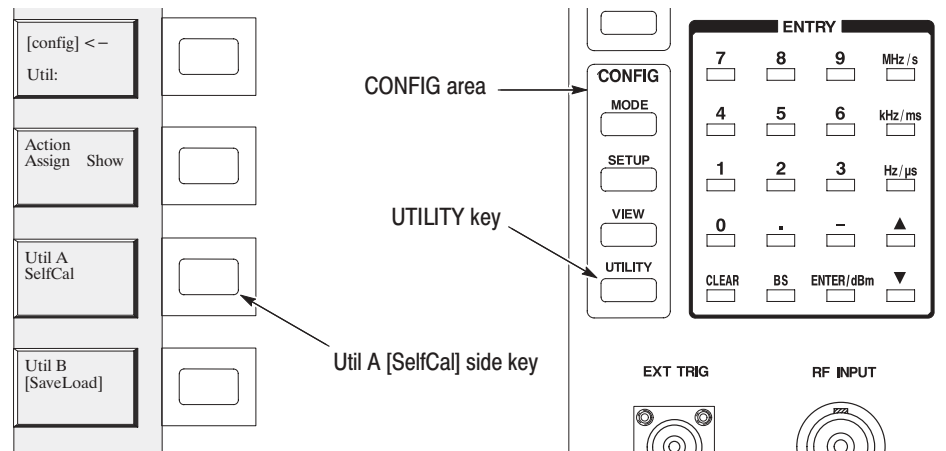

Figure 1-12: Running the self gain-calibration

IQ Offset Calibration

This calibration routine compensates the IQ signal offset between the signal source and the analyzer when inputting IQ signals directly from the rear panel connectors.

NOTE. Set the level of the I and Q signals to zero before performing the following procedure.

1. Press the **UTILITY** key in the front panel CONFIG area. See Figure 1-12.
2. Press the **Util A [SelfCal]** side key.
3. Press the **IQ Offset Cal** side key.

The calibration runs. Allow at least 30 seconds to complete the process.

Wide IQ Balance Calibration

This calibration routine compensates the DC component balance of IQ signals in the Wide mode. For the Wide mode, refer to *Selecting the IF mode* on page 3-4.

1. Press the **UTILITY** key in the front panel CONFIG area. See Figure 1-12.
2. Press the **Util A [SelfCal]** side key.
3. Press the **Wide IQ Balance Cal** side key.

Calibration runs. It takes several seconds to complete the process.

Wide IQ Full Calibration

This routine performs the factory full calibration for IQ signal balance in the Wide mode. For the Wide mode, refer to *Selecting the IF mode* on page 3–4.

1. Press the **MODE** key in the front panel CONFIG area. See Figure 1–12.
2. Press the **More...** side key twice.
3. Press the **Calibration** side key. See Figure 1–13.
4. Press the **C** side key in the **VIEW** area.
5. Press the **Wide IQ Full Cal** side key.

Calibration runs. It takes several minutes to complete the process.

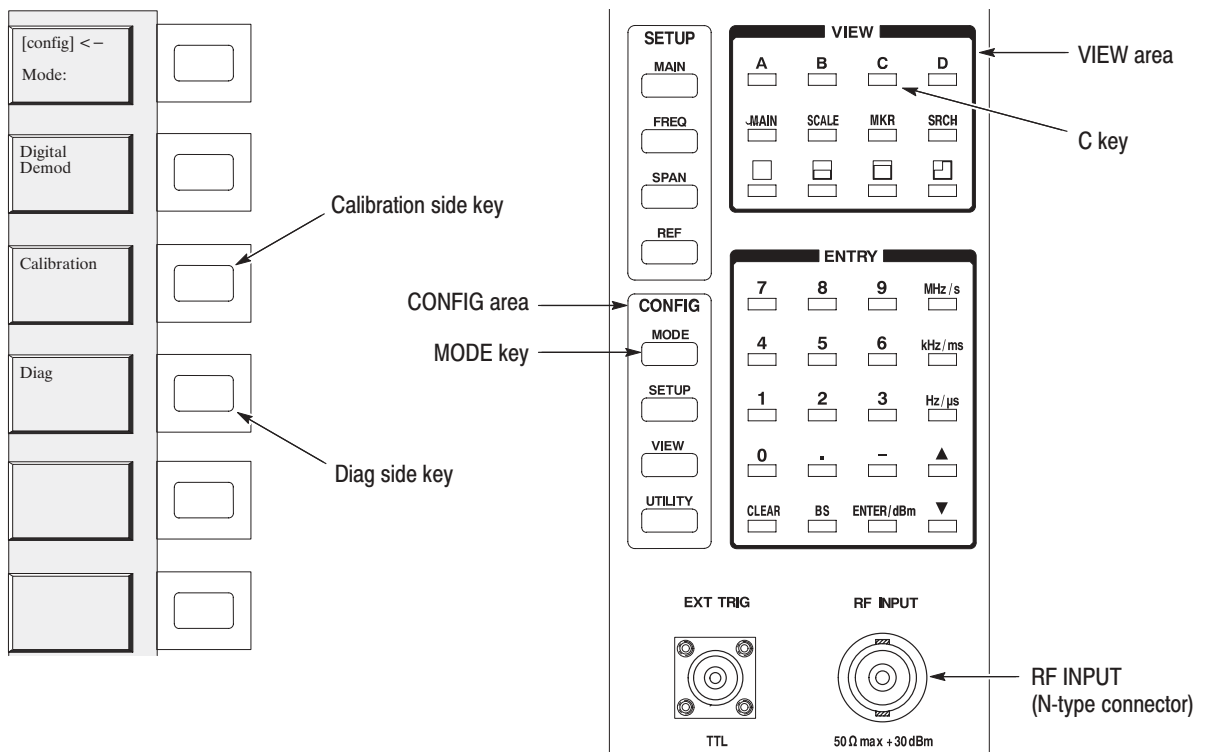

Figure 1–13: Running calibration and diagnostics

Diagnostics

You can run the internal diagnostic program to check hardware states. Table 1–1 shows test items and their descriptions.

Table 1–1: Internal diagnostic program

Item	Input band	Description
Memory	–	Check that data is written and read to/from the RAMs correctly.
Level	Baseband	Check that levels are measured correctly.
Overload		Check that overload is indicated correctly.
Freq Shift		Check that frequencies are measured correctly.
T-Domain		Check that data is continuous in the time domain.
F-Domain		Check that there is no abnormal spurious.
RF Level	RF (WCA330) RF1 (WCA380)	Check that levels are measured correctly.
RF Overload		Check that overload is indicated correctly.
RF Freq Shift		Check that frequencies are measured correctly.
RF T-Domain		Check that data is continuous in the time domain.
RF F-Domain		Check that there is no abnormal spurious.

Running the Diagnostics

This subsection explains how to run the diagnostic program. You will need a 50 Ω BNC-N coaxial cable for this test.

1. Power on the analyzer.
2. Connect the BNC-N coaxial cable to the 10 MHz REF OUT (BNC-type connector) on the rear panel and the RF INPUT (N-type connector) on the front panel.
3. Press the **MODE** key in the front panel CONFIG area. See Figure 1–13 on page 1-22.
4. Press the **More...** side key twice.
5. Press the **Diag** side key.
6. Press the **C** key in the front panel VIEW area.

7. Press the **Mode** side key to select an execution mode:

Interactive — Press the **Execute All** side key or the side key that corresponds to each test item to perform a test once.

Continuous — Press the **Execute All** side key or the side key that corresponds to each test item to perform a test repeatedly. To stop testing, press the **CLEAR** key.

StopOnFail — Press the **Execute All** side key or the side key that corresponds to each test item to perform a test until an error occurs. To stop testing, press the **CLEAR** key.

8. Press the **Execute All** side key to perform a test on every item. Press the side key that corresponds to each test item to perform a test once. Refer to Table 1-1 on Page1-23.

The execution results of the diagnostic program are displayed in the VIEW C (upper right window). The numbers of passes and fails are displayed for each test item. Passed items are shown with a green background and failed items are shown with a red background. See Figure 1–14.

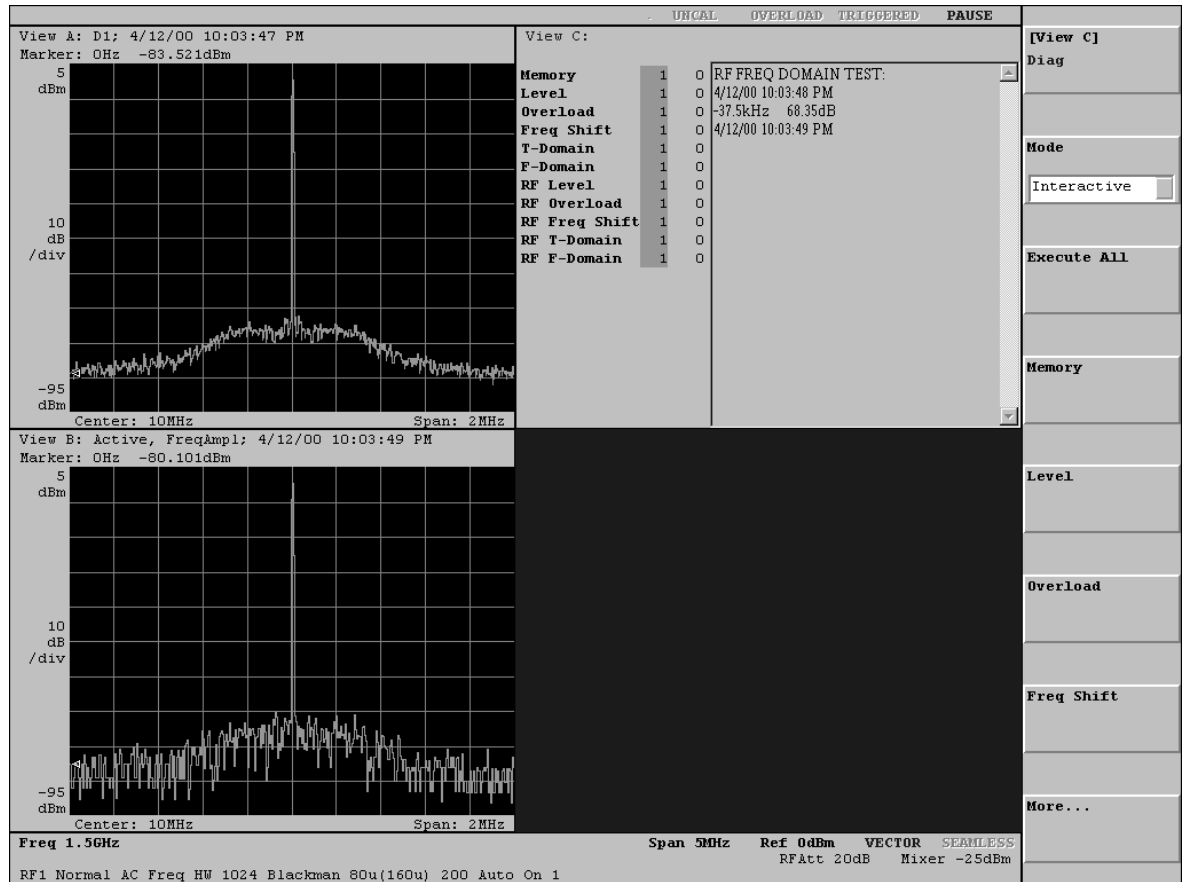

Figure 1–14: Execution results of diagnostic routines (View C)

Characteristics Check

The electrical characteristics listed in Appendix B, *Specifications*, can be checked only by our service personnel. If you need a characteristics check, contact your local Tektronix representative.

Operating Basics



Interface Maps

This section lists the names of the front- and rear-panel components and their functions. Following the descriptions of the menu operations, this section also gives brief descriptions of the menu item functions.

Front Panel

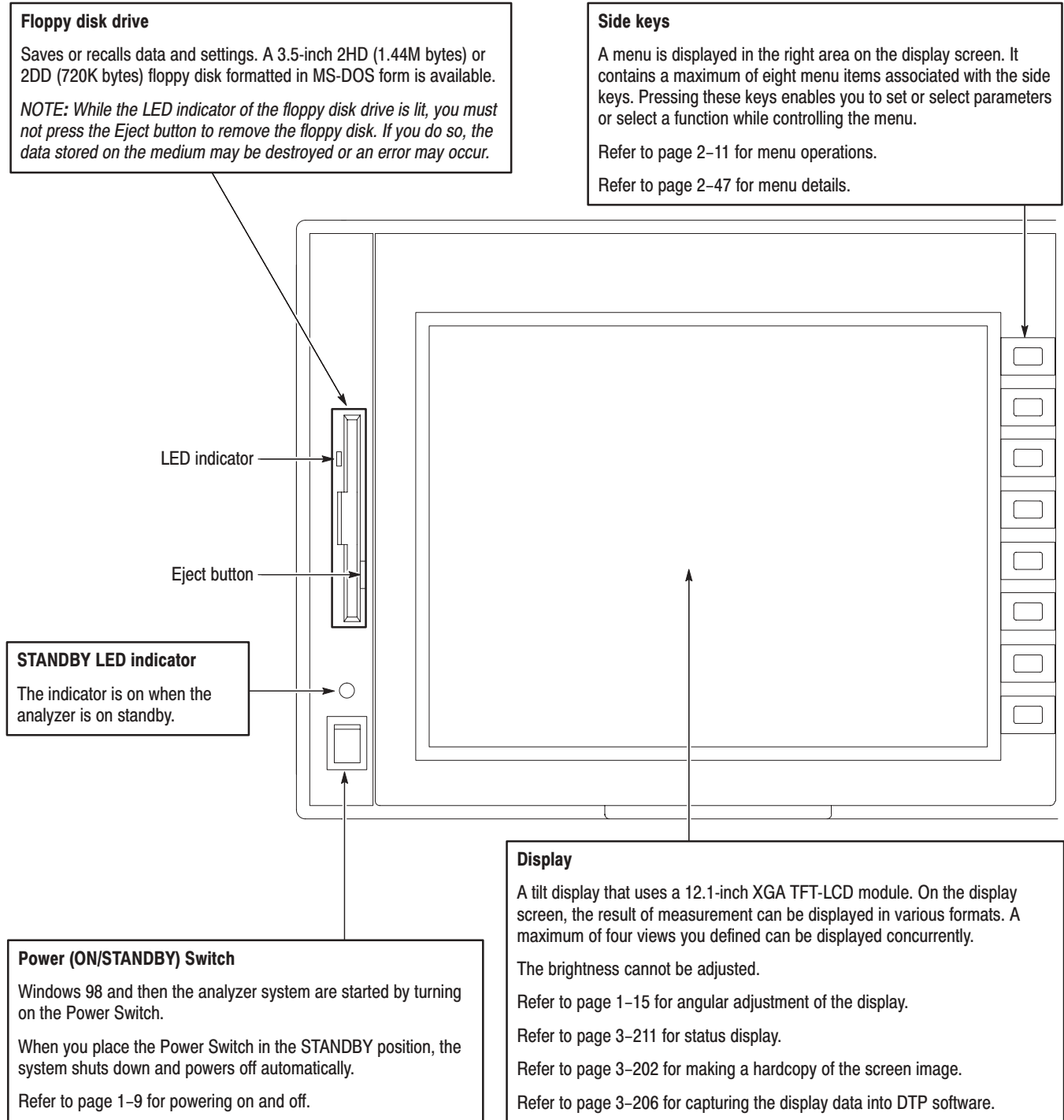

Figure 2-1: Front panel map (left part)

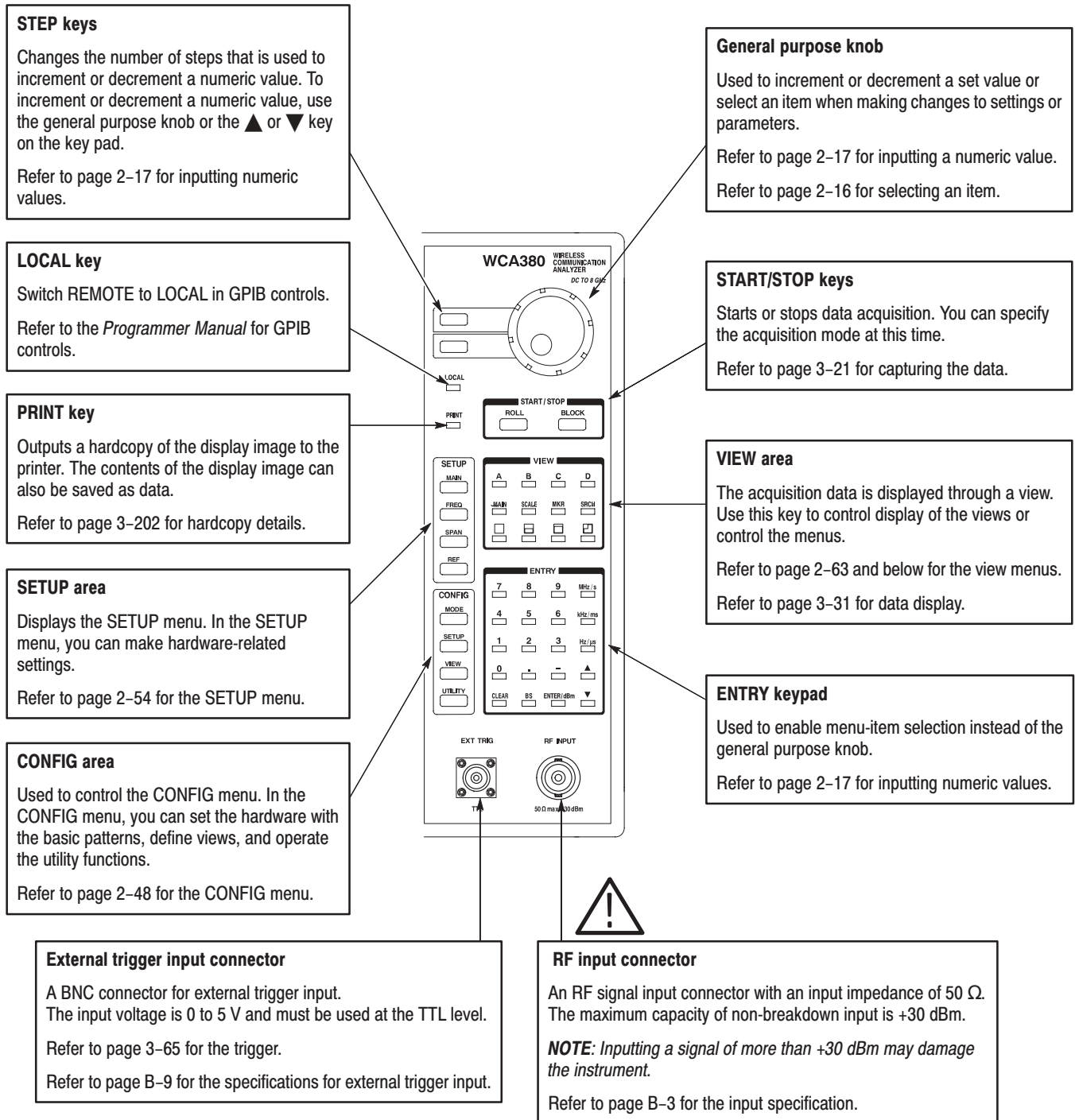

Figure 2-2: Front panel map (right part)

Rear Panel

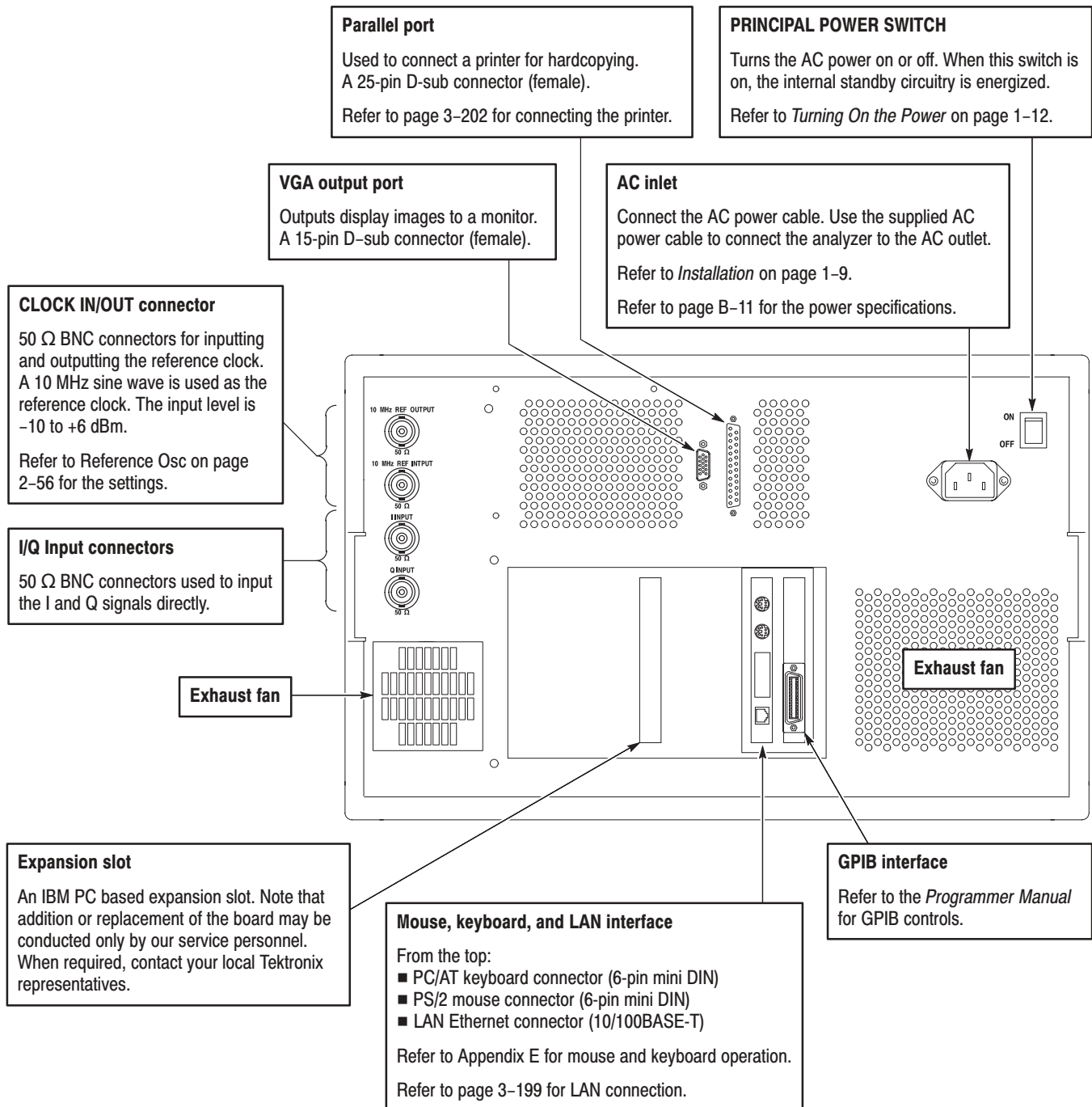

Figure 2-3: Rear panel map

Display Screen Configuration

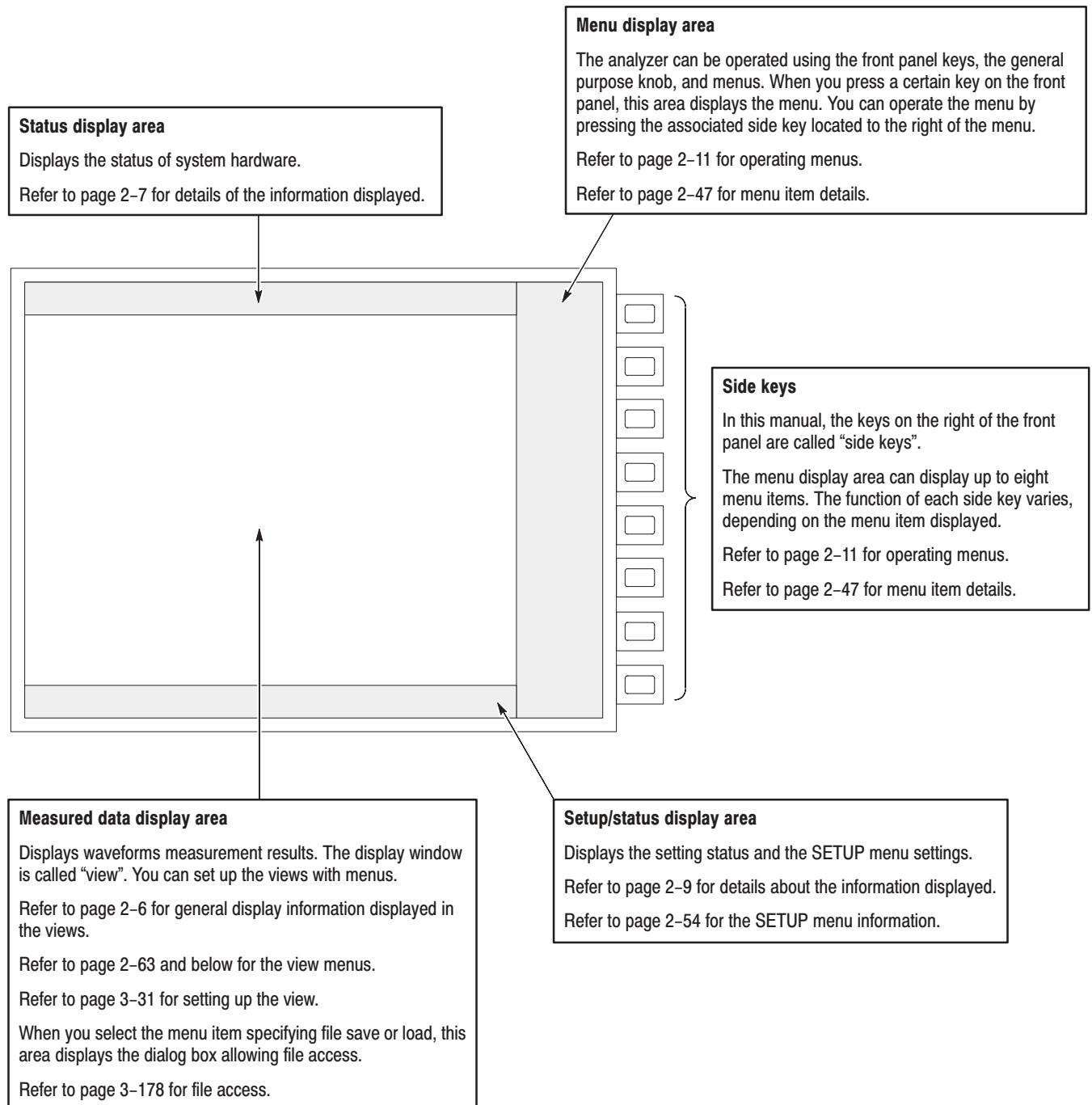

Figure 2-4: Display screen configuration

Status and Setup Display

This section shows the status display areas on the display screen and lists their details.

Status Display

The status display areas on the display screen show the six status items listed in Table 2-1 on the next page. Status messages are displayed in red or blue. Those displayed in red are warning messages.

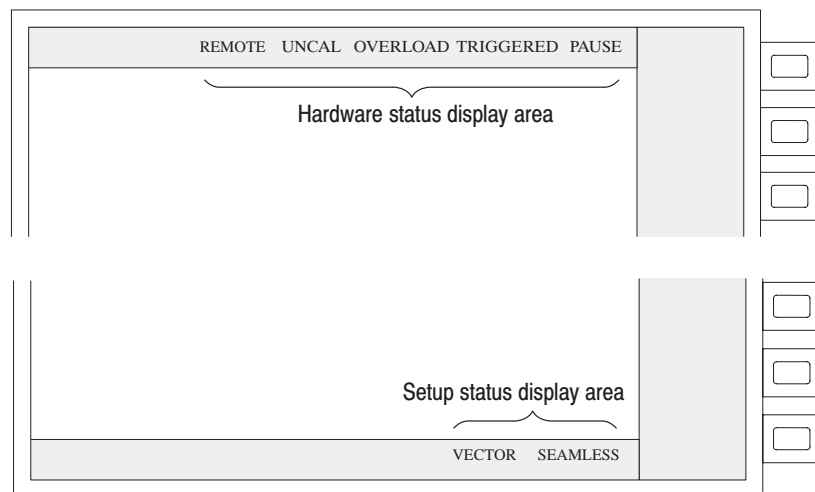

Figure 2-6: Status display areas

Table 2-1: Status display

Items	Display color	Descriptions
REMOTE	Gray / Blue	If this field turns blue, it indicates that key operations on the front panel are not available because of a remote operation.
UNCAL	Gray / Red	If this field turns red, it indicates that the gain calibration is required. Run the calibration (refer to page 1-20).
OVERLOAD	Gray / Red	If this field turns red, it indicates an overvoltage input state. Use the analyzer only while this field is gray. If overvoltage input occurs, lower the input level or change the hardware reference level setting (refer to page 3-13).
TRIGGERED	Grey / Blue	When the trigger is generated, this field turns blue. Refer to page 3-65 for the trigger.
PAUSE	Gray / Blue	While data acquisition is at a stop, this field turns blue. Refer to page 3-21 for stopping and starting data acquisition.
VECTOR	Gray / Blue	This field is gray when one frame is constructed by multiple scans. It turns blue when the span is set to acquire one-frame data by one scan (called "Vector mode"). It is always blue in the Baseband, IQ, and Wide modes. In the RF mode, it turns blue when the span is set to 6 MHz or less.
SEAMLESS	Gray / Blue	This field is blue when data is acquired seamlessly. That is there is no gap between frames. It is always seamless in the Zoom mode. In other modes, it depends on the frame period setting. Refer to page 3-26 for details.

Setup Display

The setup display area, shown in Figure 2-7, on the display screen displays the settings listed in Table 2-2 on the next page. All display items in this area are identical to those set through the SETUP menu. Refer to page 2-54 for the SETUP menu.

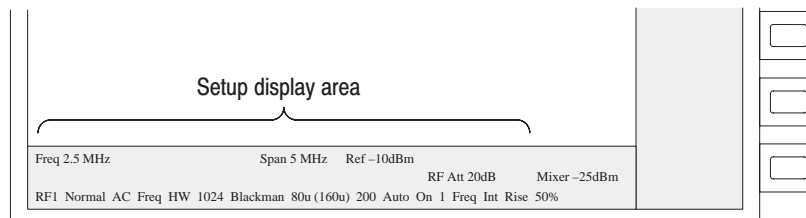

Figure 2-7: Setup display area

NOTE. When you connect a mouse to the analyzer, the Windows 98 task bar may hide the setup display area.

Table 2-2: Setup display items

Display items	Menu items
From left to right on upper row	
Frequency	SETUP:Freq,Span,Ref...→ Freq
Span	SETUP:Freq,Span,Ref...→ Span
Reference level	SETUP:Freq,Span,Ref...→ Ref
From left to right on middle row	
RF attenuator	SETUP:Freq,Span,Ref...→ RF Att
Mixer level	SETUP:Freq,Span,Ref...→ Mixer Level
From left to right on lower row	
Input band	SETUP:Band
IF mode	SETUP:IF Mode
Input coupling	SETUP:Memory Mode,Input,FFT...→ Input Coupling
Memory mode	SETUP:Memory Mode,Input,FFT...→ Memory Mode
FFT type	SETUP:Memory Mode,Input,FFT...→ FFT Type
FFT points	SETUP:Memory Mode,Input,FFT...→ FFT Points
FFT window	SETUP:Memory Mode,Input,FFT...→ FFT Window
Frame period	SETUP:Frame Period
Block size	SETUP:Block Size
Trigger mode	SETUP:Trigger...→ Mode
Trigger count	SETUP:Trigger...→ Count
Trigger count value	SETUP:Trigger...→ Times
Trigger domain	SETUP:Trigger...→ Domain
Trigger source	SETUP:Trigger...→ Source
Trigger polarity	SETUP:Trigger...→ Slope
Trigger position	SETUP:Trigger...→ Pos

* The arrow (→) indicates that the one pointed to is at the next lower level.

Menu Operations

This section describes basic operations of the menus on the analyzer and how to select the desired menu item and input numeric values. Refer to *Menu Functions* on page 2–47 for menu function details.

Displaying Menus

A menu is always displayed at the right border of the display screen. You can display any one of the three menus by pressing keys on the control panel (see Figure 2–8):

- *CONFIG* menu selects the predefined settings and configures the analyzer.
- *SETUP* menu sets frequency, span, reference level, and other parameters.
- *VIEW* menu controls waveform display and marker operation.

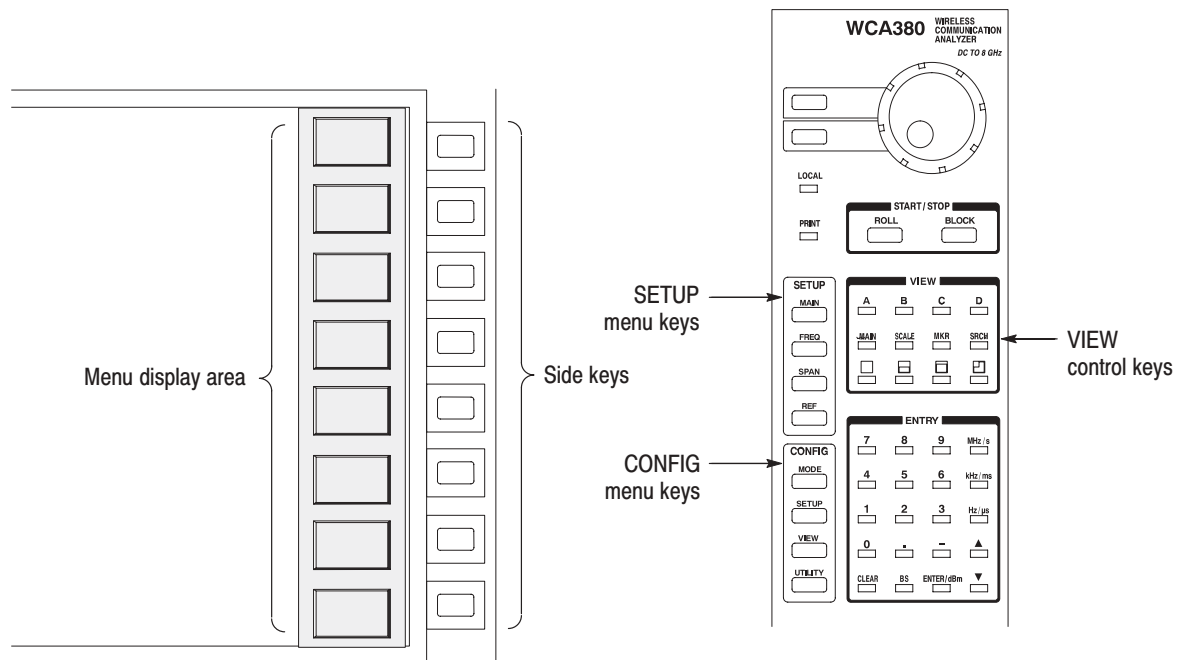

Figure 2–8: Menu display area and keys

CONFIG Figure 2–9 shows the CONFIG menu keys. When you press any of these keys, the submenu associated with the key is displayed. These four keys are shortcut keys to the submenus. You can return to the top level of the CONFIG menu by pressing the top side key.

Refer to *CONFIG Menu* on page 2–48 for the menu details.

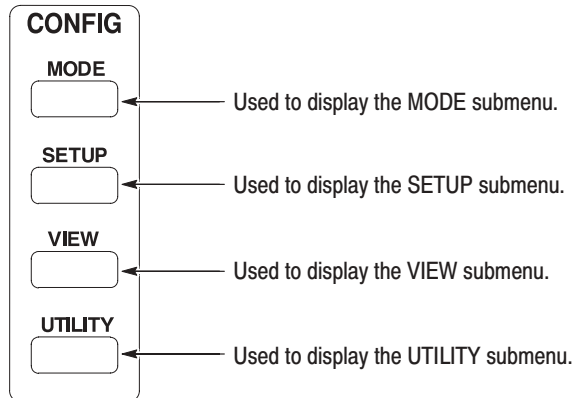

Figure 2-9: CONFIG menu keys

SETUP Figure 2–10 shows the SETUP menu keys. The top level of the SETUP menu is displayed by pressing the MAIN key. When you press one of the lower three keys, the particular submenu of the SETUP menu is displayed. The three lower keys are shortcut keys to the submenus.

Refer to *SETUP (Standard) Menu* on page 2–54, *SETUP (CDMA) Menu* on page 2–59, and *SETUP (3gppACP) Menu* on page 2–61 for the menu details.

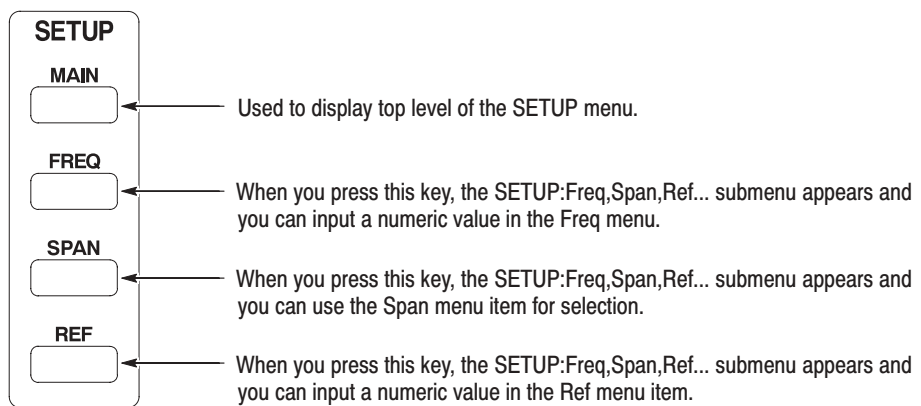

Figure 2-10: SETUP menu keys

VIEW The view is an area to display waveform and measurement results. The analyzer can display up to four views (named A to D) at the same time. The VIEW menu allows you to make settings for each associated view. To display the VIEW menu, select the view using the **A** to **D** key. See Figure 2–11.

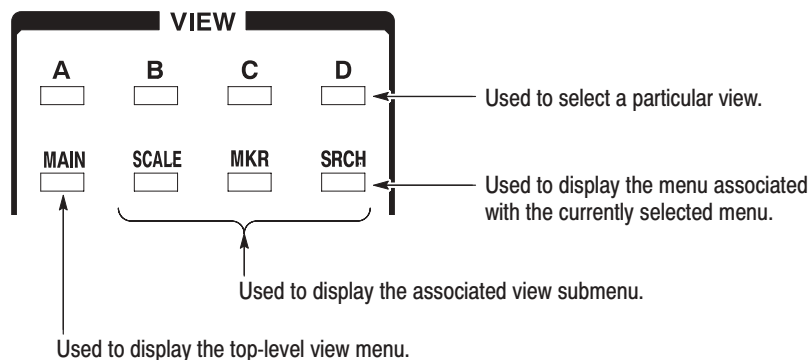

Figure 2–11: VIEW keys

For example, to use the markers for View B, do these steps to display the marker submenu:

1. Press the **B** key.
2. Press the **MKR** key.

Refer to page 2–63 and below for details on the VIEW menus.

Refer to page 3–31 for how to display data.

Menu Item Information

Each menu displayed may include up to eight menu items associated with the side keys on the right side of the display.

The menu item displayed at the top of the eight menu items, displays two or three items of information as shown in Figures 2–12 and 2–13.

You can use the top menu item to return to the upper level within the menu hierarchy. You can return to the top-level menu display by pressing the side key (to the right of the display) once or twice. If you are at the top level of a menu, the system displays information as shown in the upper illustration in Figure 2–12. If you are at a submenu, the system displays information as shown in the lower illustration.

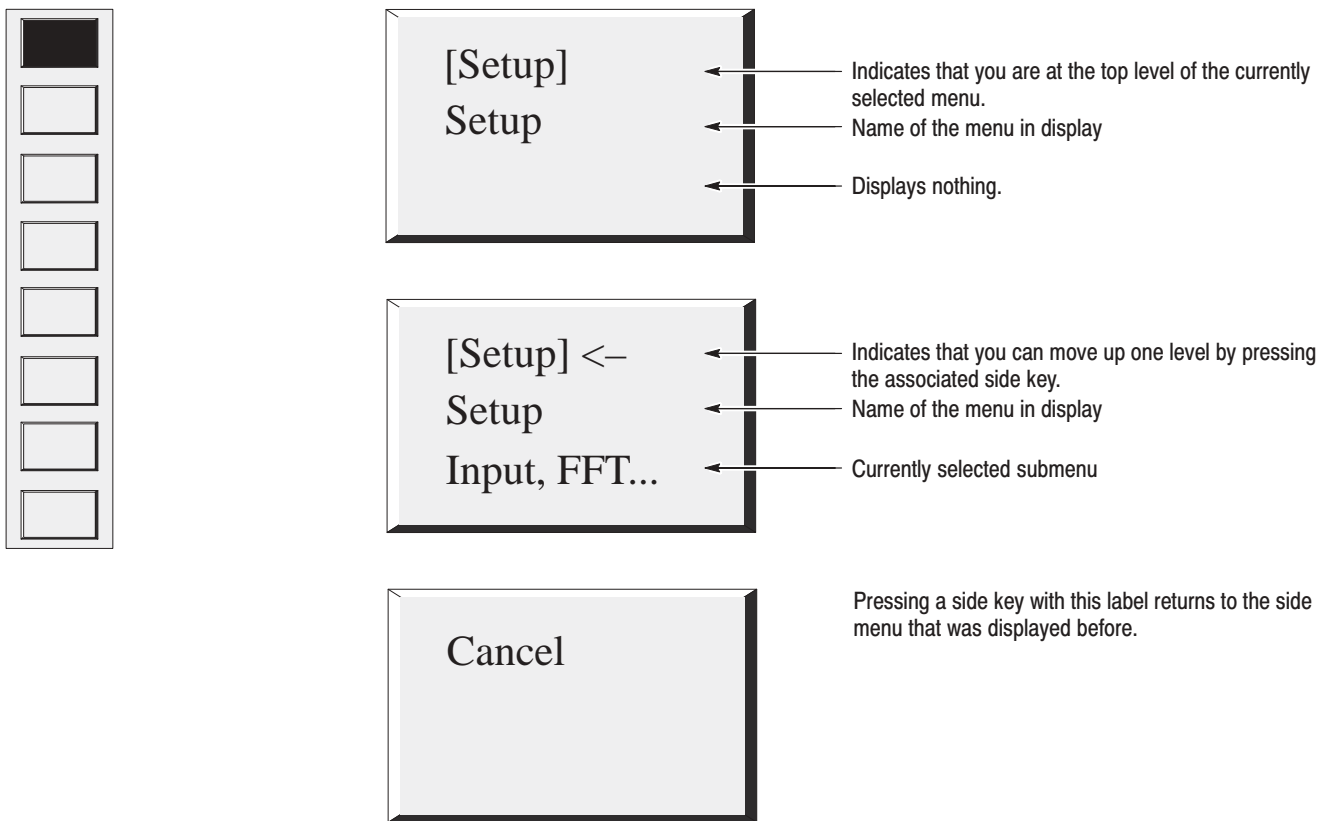
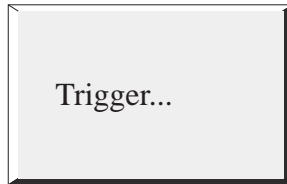
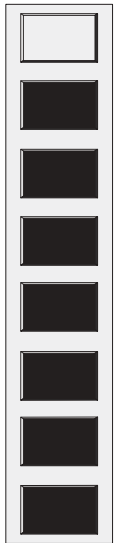

Figure 2-12: Examples of top menu item display

The second through eighth menu items in the displayed menu are used to set or select a menu item or to move to a submenu. Figure 2–13 shows many of the menu items.

NOTE. If a setting for a menu item is not allowed or is disabled, its label remains gray.



If the label is followed by "...", you can move to the lower-level submenu by pressing the associated side key.

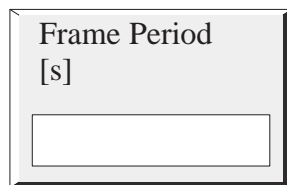

The parameter or option values are displayed together with the menu item label. You can press the associated side key to select an option or to input a value.

See page 2-16 for how to select an item or to input a value.

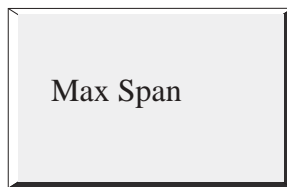

When you press the associated side key, the function indicated with the label runs. In this example, the maximum span is set in the Span menu item.



When you press the associated side key, the File Access menu appears. You can save or load a file through this menu.



Toggle menu items switch between the two displayed options when you press the associated side key.

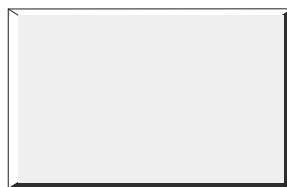

Menu items without labels do not cause any response.

Figure 2-13: Examples of lower menu item display

Selection and Numeric Input

Figure 2–14 shows the configurations of a menu item that requires selection or numeric input.

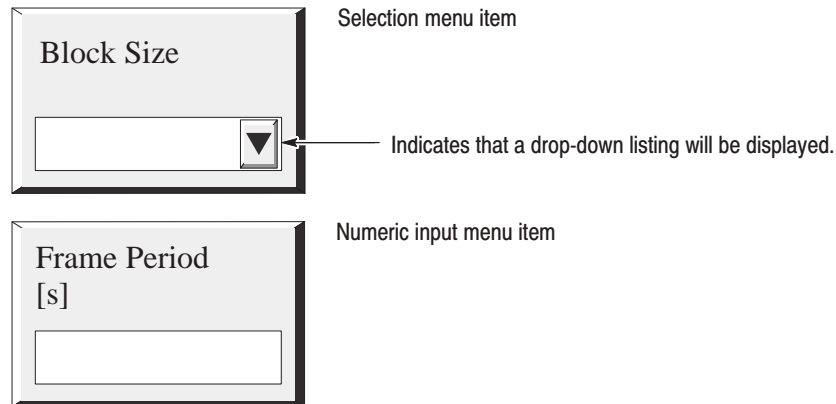

Figure 2-14: Menu items requiring selection or numeric input

Selecting an Item

Use the following procedures to select an item:

1. Press the associated side key.

The menu item changes to the display as shown in Figure 2–15 below:

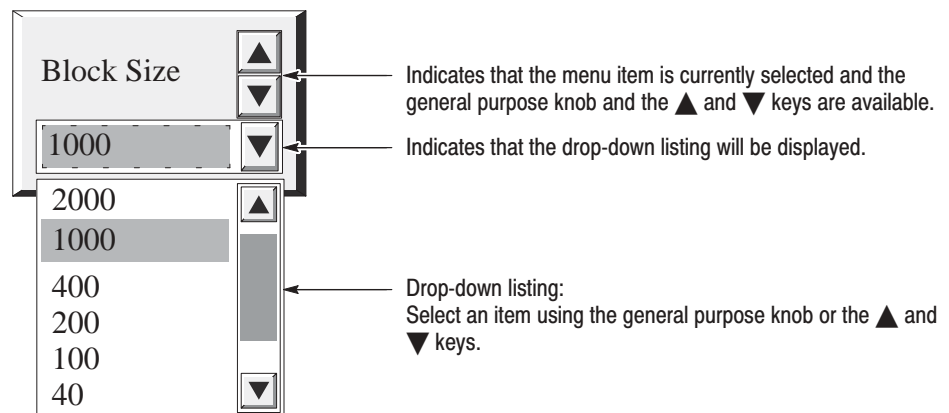

Figure 2-15: Drop-down list for selecting an item

2. Turn the general purpose knob to move the blue item within the drop-down listing, and select an item. Alternatively, you can use the ▲ and ▼ keys for the selection.

3. Press the side key again to finish the selection. You can also use the **ENTER/dBm** key in the keypad.

The selected item is immediately reflected in the analyzer settings or views.

To cancel the selection, press the **CLEAR** key in the keypad.

If the setting field is blue even if the drop-down list is not displayed, the general purpose knob and the ▲ and ▼ keys are available for selection. In this case, the selection is established without pressing the side key after selection.

Numeric Input

Use the following procedures to input a numeric value.

1. Press the associated side key.

The menu item changes to the display as shown in Figure 2–16 below:

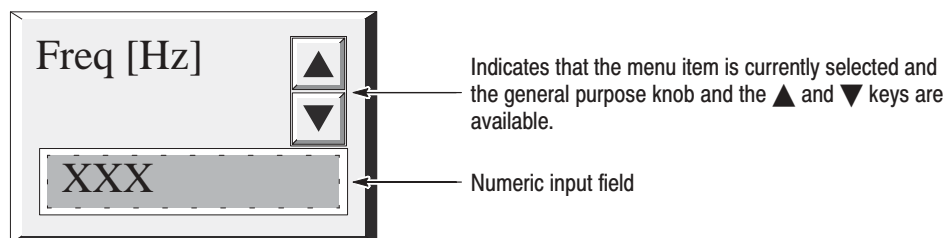

Figure 2–16: Side menu item for numeric setting

2. To change the numeric value, you can type in the new value or increase or decrease the current value.

Numeric Input. Input the new value using the following procedure. Use the ENTRY area keys in the keypad.

- a. Type a value with the numeric keys.

You can delete a digit using the **BS** or a selection with the **CLEAR** key.

- b. Press the unit key to establish the input.

The new values are immediately reflected in the analyzer settings or views.

Increase/Decrease. Increase or decrease the displayed value using the following procedure:

- c. Use **Step** keys to the left of the general purpose knob to change the increment of a setting value.

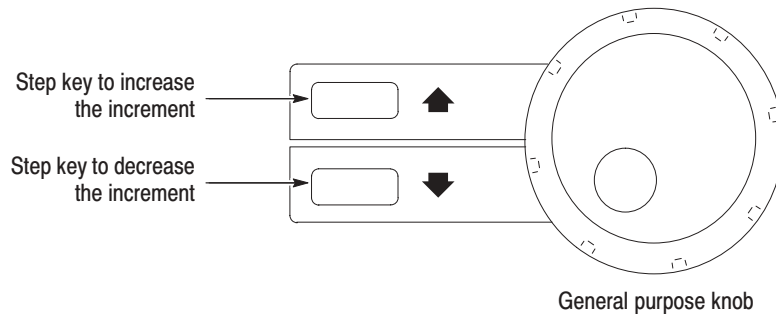

Figure 2-17: Step keys

Pressing a **Step** key causes the value to change in the numeric input field. The increment is 1 MHz in the example illustrated below, that is, the frequency will be set in 1 MHz step. It is changed by pressing a **Step** key repeatedly.

Set the desired increment while observing the display.

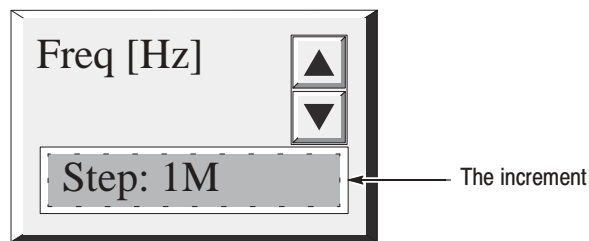

Figure 2-18: Increment display

- d. Increase or decrease the numeric value (in this example, the frequency) by turning the general purpose knob or pressing the ▲ and ▼ keys.

When necessary, repeat steps **c** and **d** to obtain a desired value more quickly.

The established values are immediately reflected in the analyzer settings.

Tutorial

This section describes basic operating procedures, such as applying power, displaying the results of measurements, and powering off the analyzer. This section uses default settings as much as possible. The following procedures are included in this section:

- Connecting the hardware components and powering up
- Configuring basic patterns
 - Measuring the spectrum
 - Measuring the digitally-modulated signal
- Making changes to the hardware settings
- View definitions and layout
- Using averaging and compared displays
- Using peak search and zoom functions
- Using delta markers
- Powering down

These procedures assume that the installation procedure beginning on page 1–9 has already been completed.

Preparations

Prepare the following equipment for use in the examples:

- Digitally-modulated signal generator
Recommended signal generator: Rohde & Schwartz SMIQ
- One 50 Ω coaxial cable

Connecting the Signal Generator

1. Connect the standard mouse to the rear panel connector of the analyzer. Refer to *Connecting the Mouse* on page 1–11.
2. Connect the signal generator output through the cable to the RF INPUT connector on the front panel (see Figure 2–19).

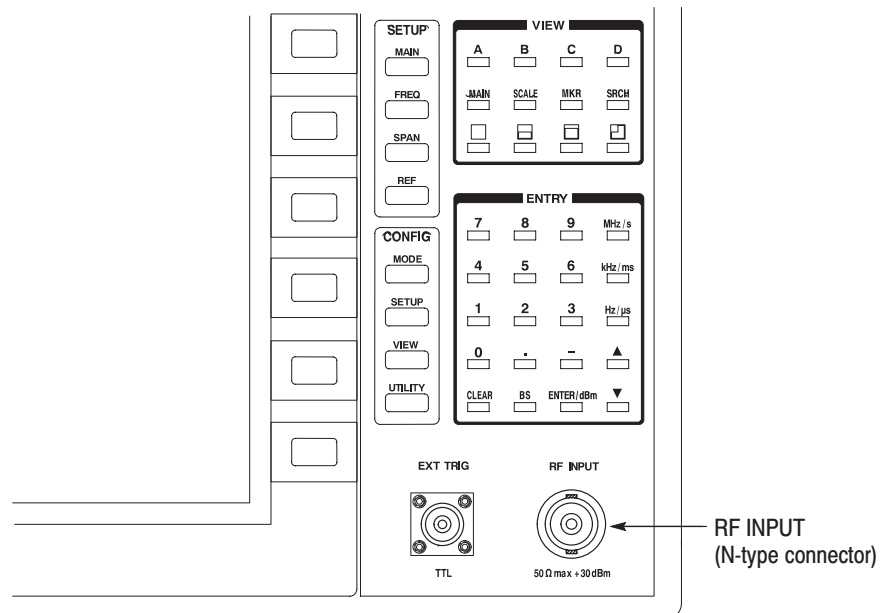

Figure 2–19: Cable connection

3. Set the signal generator as follows:

Center frequency	800 MHz
Modulation	PDC modulation system
Symbol rate	21 kHz
Filter	Root Raised Cosine
α /BT	0.5
Output level	-10 dBm
Modulation data	Pseudo-random pattern

Applying Power

1. Power up the signal generator.
2. Press the principal power switch found on the rear panel of the analyzer, then press the power switch (**ON/STANDBY**) shown in Figure 2-20 to toggle the analyzer into operation.

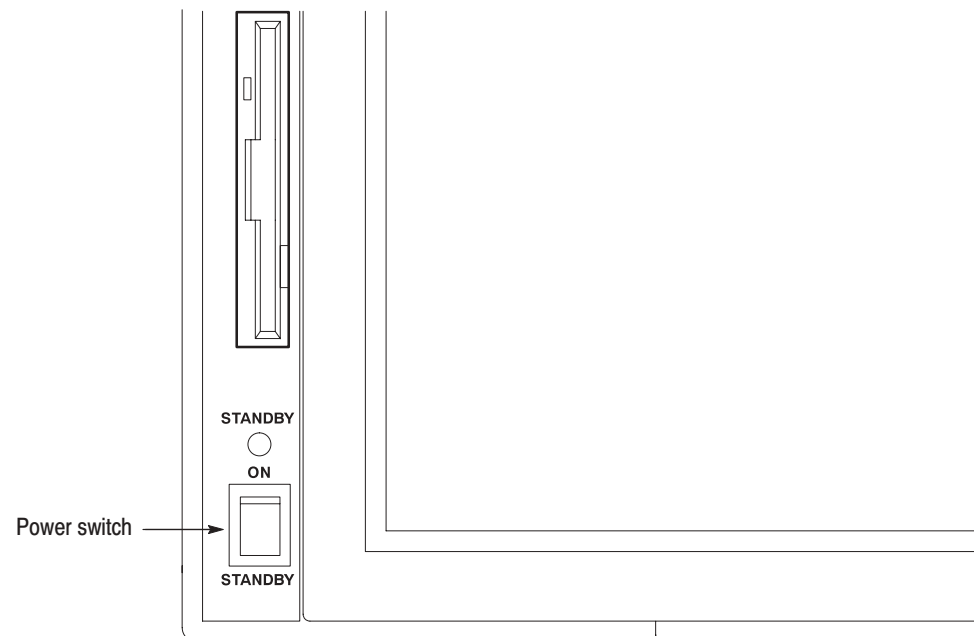

Figure 2-20: Power switch

The analyzer should boot up with the initial screen shown in Figure 2–21. This concludes the analyzer preparation tutorial.

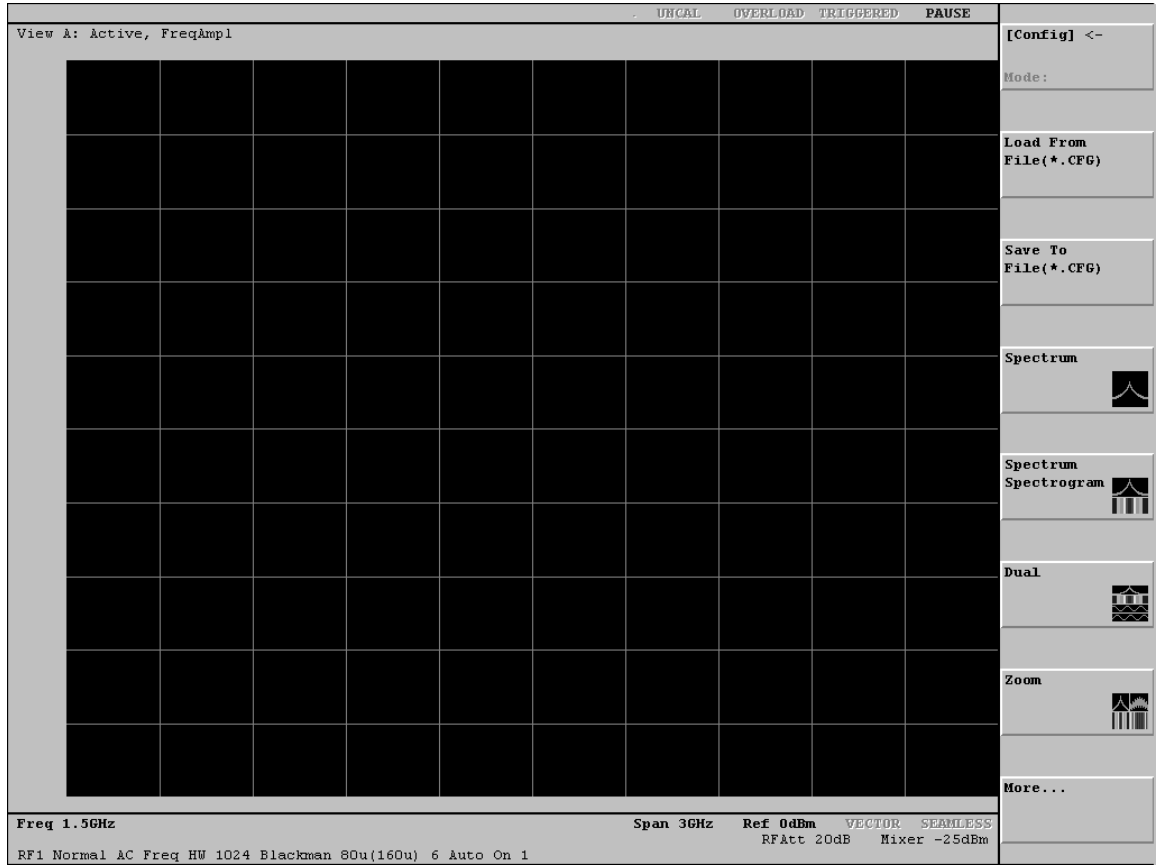

Figure 2–21: Initial screen

Configuring the Analyzer with Basic Configuration Patterns

This section describes the easy way to measure a spectrum using the basic configuration patterns in the CONFIG:MODE menu.

Measuring the Spectrum

Follow these steps to quickly measure the spectrum of the input signal.

1. Press the **MODE** key in the CONFIG area (see Figure 2–22).

When you press the CONFIG:**MODE** key, the CONFIG:MODE menu is displayed at the right side of the screen.

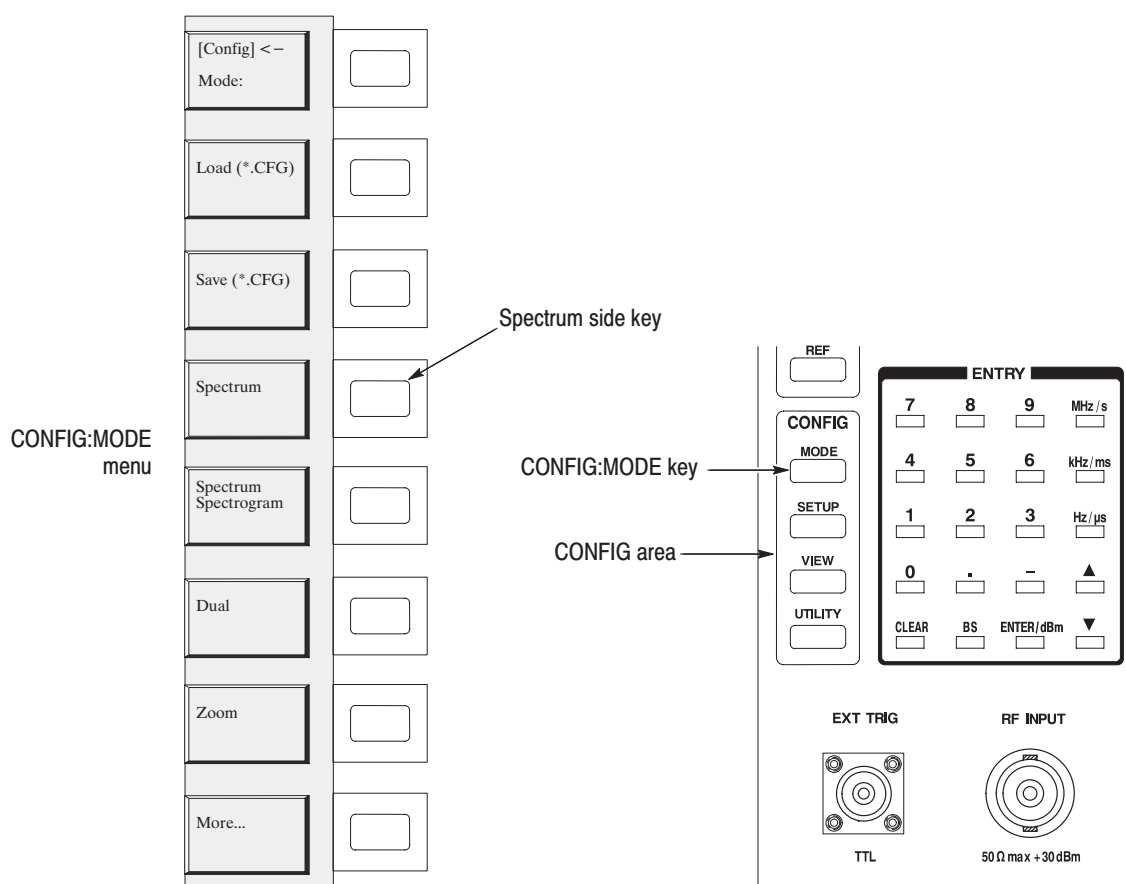

Figure 2–22: CONFIG:MODE key and the menu

2. Press the **Spectrum** side key.

This key selects measurement of the spectrum with a default span of 3 GHz and a center frequency of 1.5 GHz. The display in Figure 2–21 is unchanged because the initial screen defaults to the Spectrum.

Starting and Stopping Measurement (Roll Mode)

The Roll mode acquires data continuously and simultaneously displays current measurements of the displayed signal.

1. Press the **ROLL** key on the front panel. See Figure 2–23.

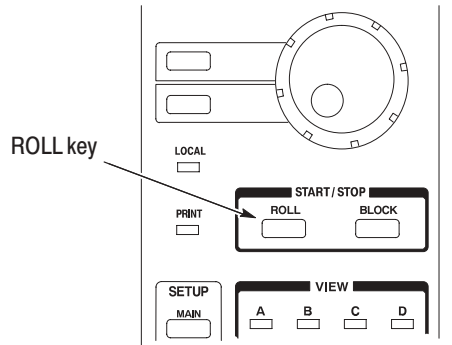

Figure 2–23: Control of the start and stop of measurement

Figure 2–24 shows an example of the spectrum display.

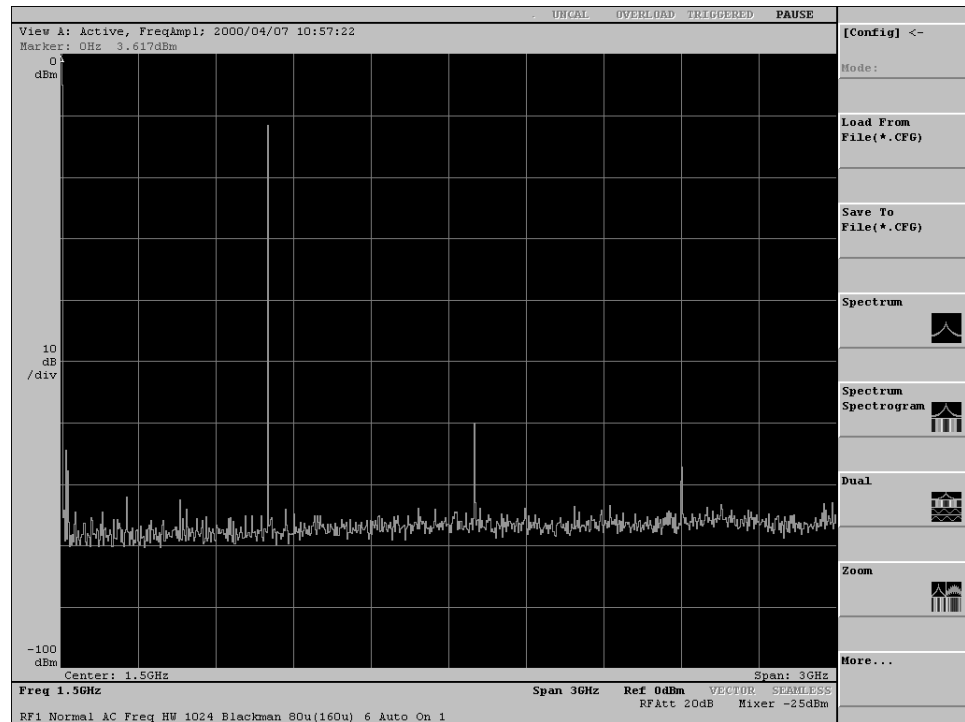

Figure 2–24: Spectrum measurement with a span of 3 GHz

2. Press the **ROLL** key to stop the measurement. See the PAUSE status in the status display area as shown in Figure 2–25.

If PAUSE is in blue: The measurement is currently stopped.

If PAUSE is in gray: The measurement is in progress.

Press the **ROLL** key to stop the measurement.

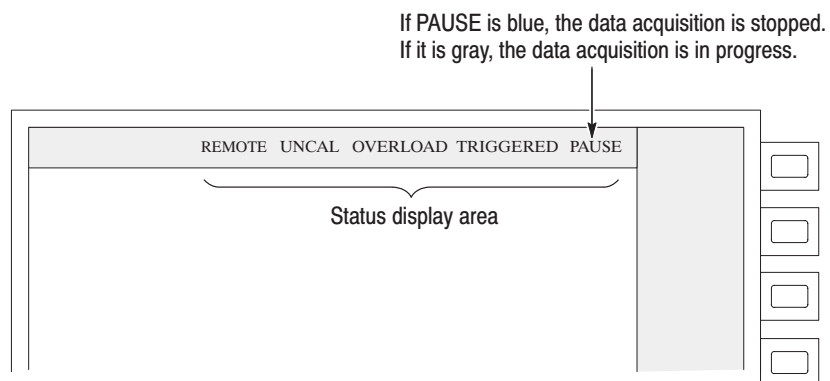

Figure 2–25: Status display area

Measuring a Digitally-Modulated Signal

Now, measure a digitally-modulated signal with the basic configuration pattern.

1. Press the **MODE** key in the CONFIG area again (see Figure 2–22).
2. Press the **More...** side key and then **Digital Demod** side key in the menu.

The display view changes as shown in Figure 2–26. The analyzer is set to a span of 3 GHz and a center frequency of 1.5 GHz. It now displays the spectrum, spectrogram, vector (constellation), and EYE pattern in the four views.

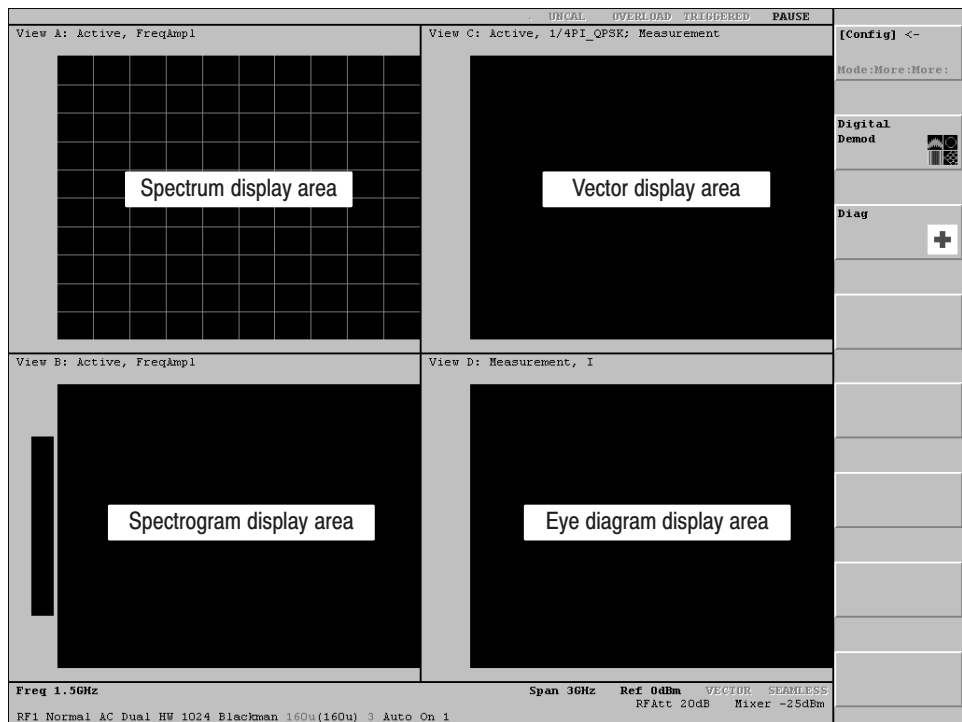

Figure 2–26: Four-view display for digital modulation analysis

Starting and Stopping Measurement (Block Mode)

Now, acquire a signal in the Block mode. This mode acquires the data in blocks before displaying the measurement result.

1. Press the **BLOCK** key.

Note that the Block mode is not yet active because of the current settings. The analyzer continues to use the Roll mode to acquire the signal. Figure 2–27 shows the current view.

The display in this example contains neither the vector nor the EYE pattern. It is because the span is so great (3 GHz) that the analyzer cannot capture the digitally-modulated signal. These views can be obtained by specifying a proper span and center frequency.

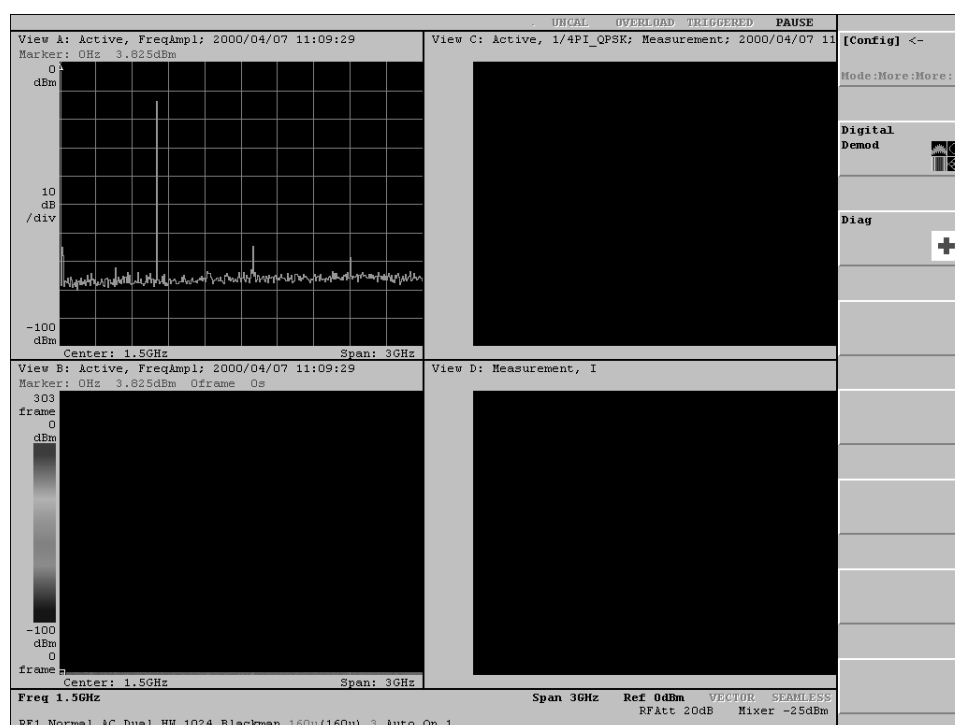

Figure 2–27: Measuring the digitally-modulated signal – Span 3 GHz

2. Stop the Roll mode acquisition .

Changing Hardware Settings

In this section, you learn how to make changes to the hardware settings through the SETUP menu.

For the previous views, the default center frequency and span settings were used for measurement. You can change the center frequency and span using the keys in the SETUP area and the SETUP menu.

Changing the Center Frequency

The center frequency is initially set to the default value 1.5 GHz. Change it to 800 MHz.

1. Press the **FREQ** key in the SETUP area (see Figure 2–28).

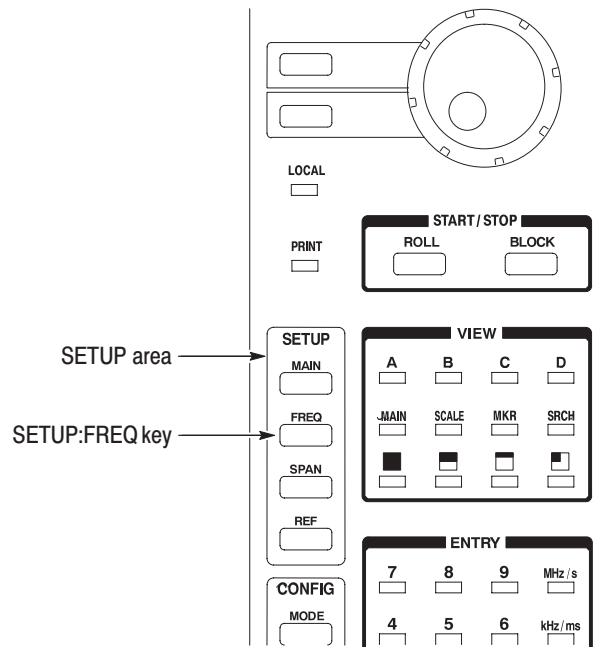

Figure 2-28: SETUP:FREQ key location

The Freq, Span, Ref... submenu is displayed in the menu display area. Note that numeric input in the Freq menu item is already available for adjustment. See Figure 2–29.

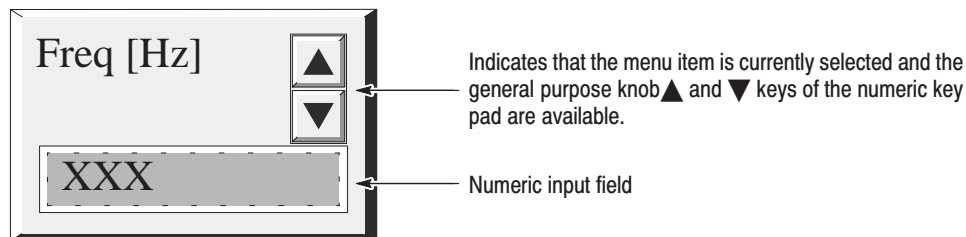

Figure 2-29: Freq side menu item available for numeric input

2. Input the new center frequency 800 MHz: In the ENTRY area, press the key **8 0 0 MHz/s** in order.

NOTE. When you input 800 MHz in this state, the display returns to 1.5 GHz. You must go on and set the span before the new center frequency (800 MHz) is available. For details, refer to Buffering the Input Values on page 3-11.

The **MHz/s**, **kHz/ms**, **Hz/μs**, and **ENTER/dBm** keys function in the same manner as the **ENTER** key. They establish the numeric value you typed in. When you press any of these keys, the hardware is immediately set up with the values you selected.

If you type in an erroneous digit, correct it using the **BS** (back space) or **CLEAR** key.

You can also change the numeric value using the general purpose knob or the ▲ and ▼ keys in the ENTRY area. See Figure 2-30.

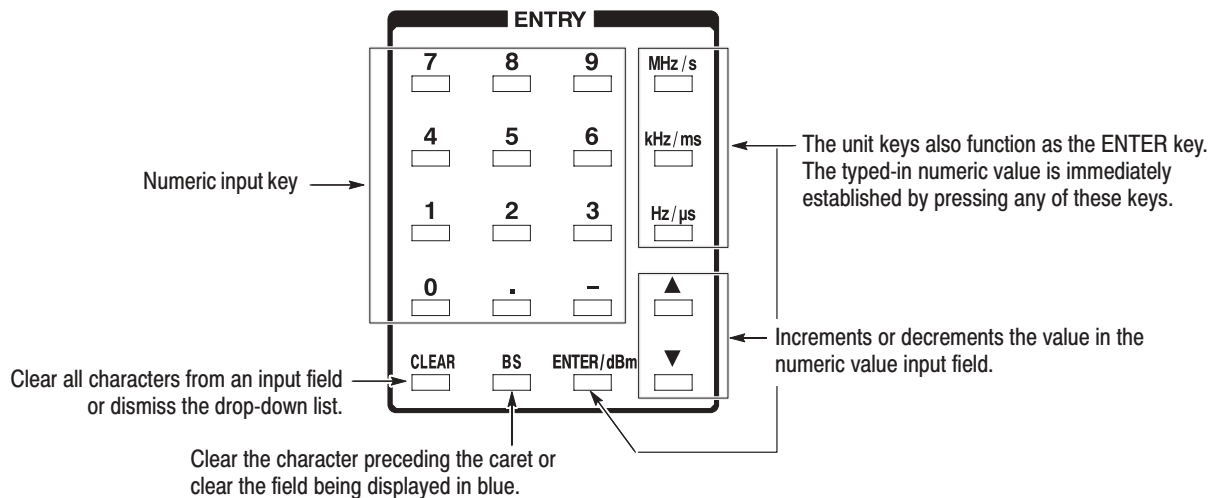

Figure 2-30: Numeric input keypad

Changing the Span

The currently displayed menu indicates that the span is set to the default value 3 GHz. Change it to 100 kHz.

1. Press the **Span** side key.

A drop-down list appears to select the desired item. See Figure 2–31.

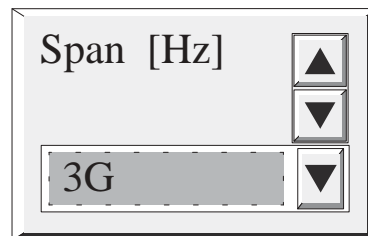

Figure 2-31: Span side menu item available for numeric input

2. Select **100k** using the general purpose knob.
3. Press the **Span** side key again.

The hardware is set up immediately with the new value.

NOTE. After the span has been changed, the relationship between the span and the frequency input in Step 2 falls within the allowable range. Now the 800 MHz center frequency, input previously, is displayed in the Freq menu.

Starting and Stopping the Measurement (Block Mode)

With the center frequency and span set to appropriate values, you can now use the Block mode to acquire data. This mode displays the result of measurement after the data has been acquired in blocks.

1. Press the **BLOCK** key on the front panel.

Unlike the Roll mode, the Block mode requires a longer time to display the data. This is because the data is displayed only after enough is acquired to fill the specified block size. After acquiring one block of data, the analyzer displays the data.

Make sure that SEAMLESS is displayed in blue in the setting status display area at the bottom of the display (see Figure 2–32). It indicates that the data is being acquired continuously, i.e., there is no time gap between two adjacent frames. The settings allowing the seamless acquisition depend on the frame period and span settings. Refer to *Frame Period and Real Time* on 3–25 for the details.

Also check that the PAUSE display is gray in the hardware status display area (see Figure 2–32).

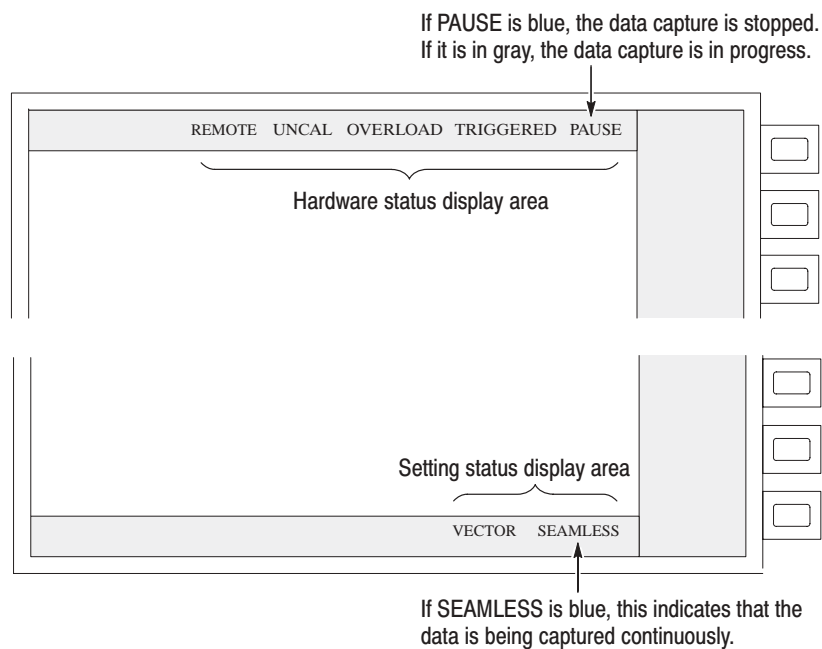

Figure 2–32: Setup display areas

Figure 2–33 shows the measurement result using the new center frequency and span. Note that the display scale has automatically changed in accordance with the center frequency and span settings.

You now have a proper vector display and Eye diagram. Try changing the span. This modifies the two views, especially the Polar view located at the top right corner on the display. It has a mechanism to demodulate the digitally-modulated signal. The Eye diagram view uses the demodulated signal in the Polar view. If the span is too great or small, the modulated signal cannot be analyzed.

Try changing the frequency in fine increments using the general purpose knob. Note how the display diagram changes.

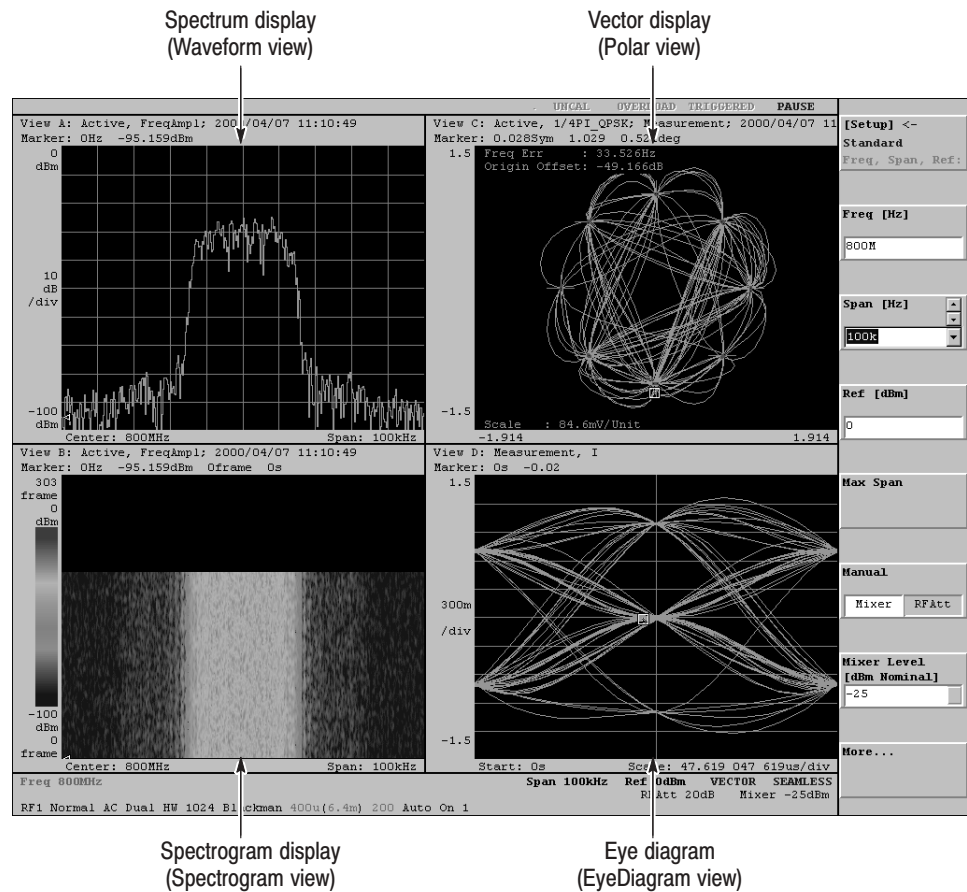

Figure 2–33: Views resulting from changes to the frequency and span settings

View Definitions and Layout

In this section, you learn how to define a view or a window used to display waveform and results of measurement.

The view is a window used to display waveform and results of measurement. This system allows you to define up to eight (A to H) views and display up to four views at the same time. You can specify how the waveform and results are displayed in each of the defined views.

In the subsequent sections, you modify the view located at the bottom right corner on the screen to the Waterfall display.

Checking the View Definitions

Four views of A to D are already defined with the basic configuration. First, check their definitions.

1. Press the **VIEW** key in the CONFIG area (see Figure 2–34).

The display area shows the menu used to set the format of the four views (see Figure 2–34).

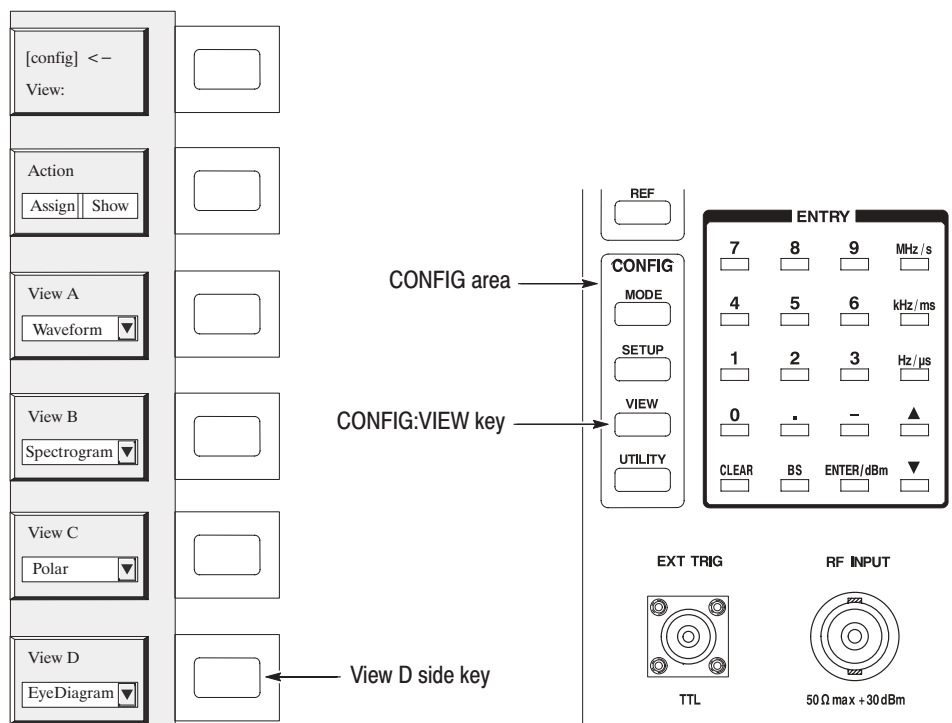

Figure 2–34: CONFIG:VIEW key and its submenu

Redefining a View

The view A to D are now defined as follows (see Figure 2–33 on page 2–32):

- View A (upper left of the screen): Waveform
- View B (lower left of the screen): Spectrogram
- View C (upper right of the screen): Polar
- View D (lower right of the screen): Eye diagram

Change the View D definition from Eye diagram to Waterfall.

2. Redefine View D:

- a.** Press the **View D** side key.

A drop-down listing appears to select the desired item (see Figure 2–35).

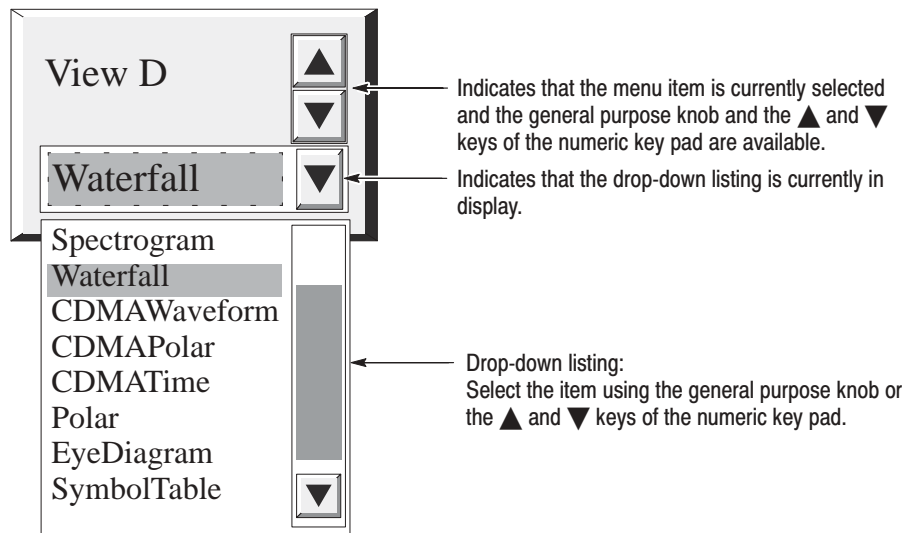
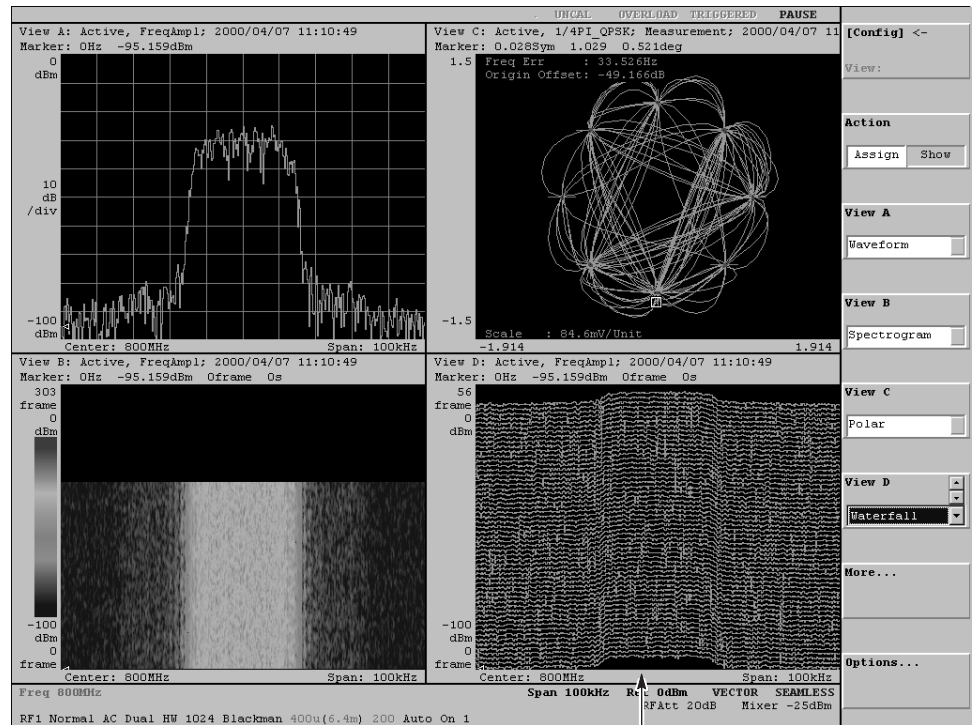

Figure 2–35: Selecting the Waterfall view

- b.** Select **Waterfall** from the drop-down listing by turning the general purpose knob.
- c.** Press the **View D** side key again to enable the view settings.

Figure 2–36 shows an example of the views with the new settings.



Waterfall view

Figure 2-36: Making changes to View D

View Layout The views are placed in predefined positions on the display screen. At present, they are placed in the two-by-two layout as shown in Figure 2–37. If a view is not defined, the area is empty.

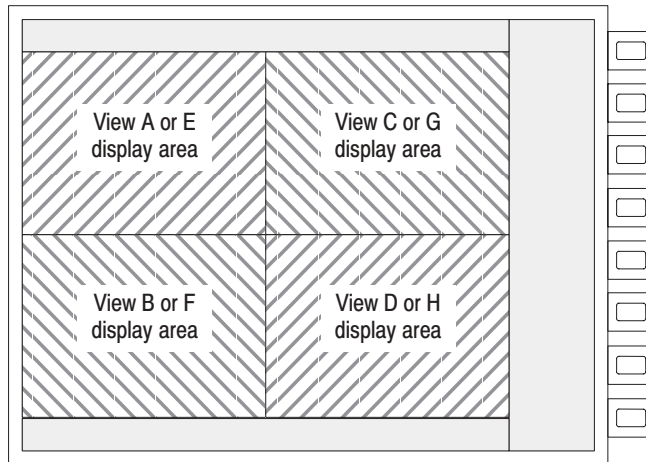



Figure 2-37: Four-view display layout

3. Modify the View B display layout.
 - a. Press the  key in the VIEW area (see Figure 2–38).
 - b. Press the **B** key in the VIEW area (see Figure 2–38).

View B is displayed fully on the screen. See Figure 2–39.

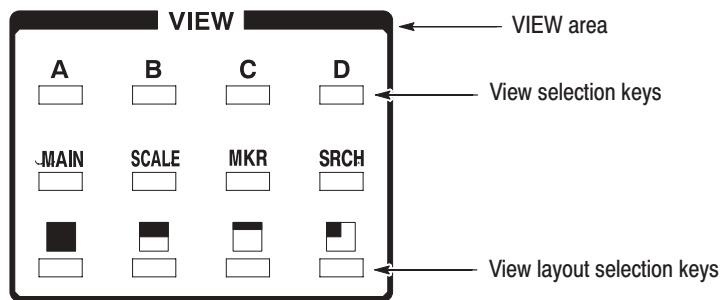

Figure 2-38: VIEW keys (view control keys)

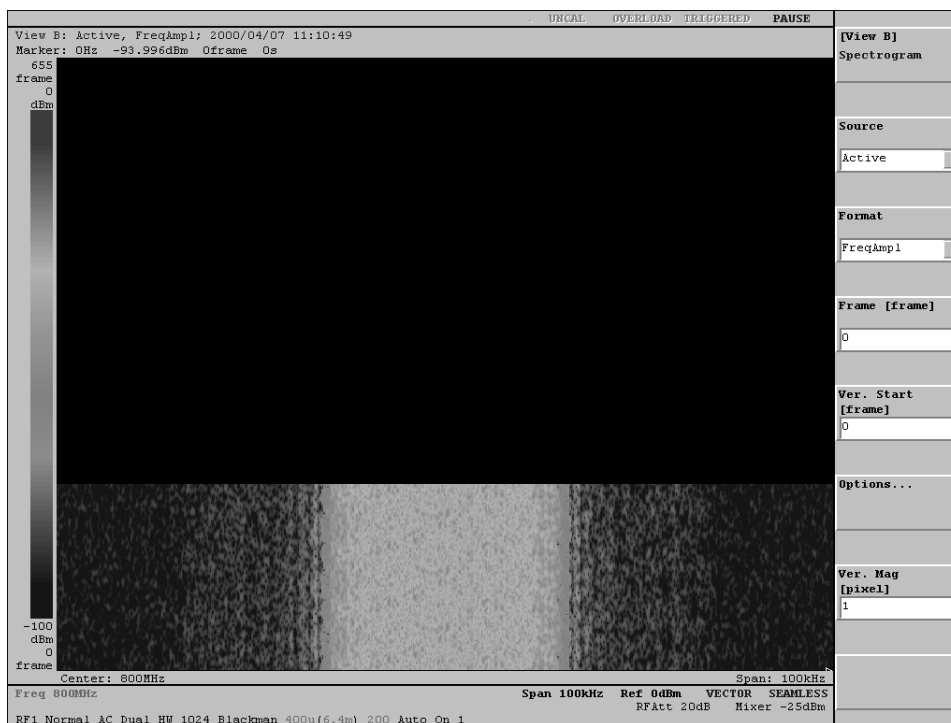





Figure 2-39: View B display (1-view display)

- c. Try pressing the **A** to **D** keys in the VIEW area.
- d. Try pressing the , , and  keys and the **A** to **D** keys in various combinations to see the possible view configurations.

Averaging and Compared Display

The Waveform view has the averaging function that reduces noise on a waveform. In this section, you learn how to compare averaged waveform with the original.

Setting Up the Averaging

The Waveform view is predefined for View A. Modify the averaging parameters.

1. Modify the averaging parameters:
 - a. Press the **VIEW:A** key. (“VIEW:A” means the **A** key in the VIEW area on the front panel. The keys may mentioned like this hereafter.)
 - b. Press the **VIEW:MAIN** key.
 - c. Press the **Average...** side key.
 - d. Press the **Average** side key to select **On**.
 - e. Press the **Average Type** side key to select **RMS**.
 - f. Press the **Num Averages** side key to set the number of sweeps for averaging. For example, enter **64** using the numeric keypad or the general purpose knob.

Acquiring and Displaying the Signals

Perform the averaging.

2. Press the **ROLL** key on the front panel.

The averaging does not work if you press the **BLOCK** key. Pressing the **BLOCK** key displays the original spectrum without averaging.

The averaged waveform is displayed on the screen. With the averaging parameter settings above, the process stops after 64 sweeps. If you want to restart the averaging, press the **Reset** side key.

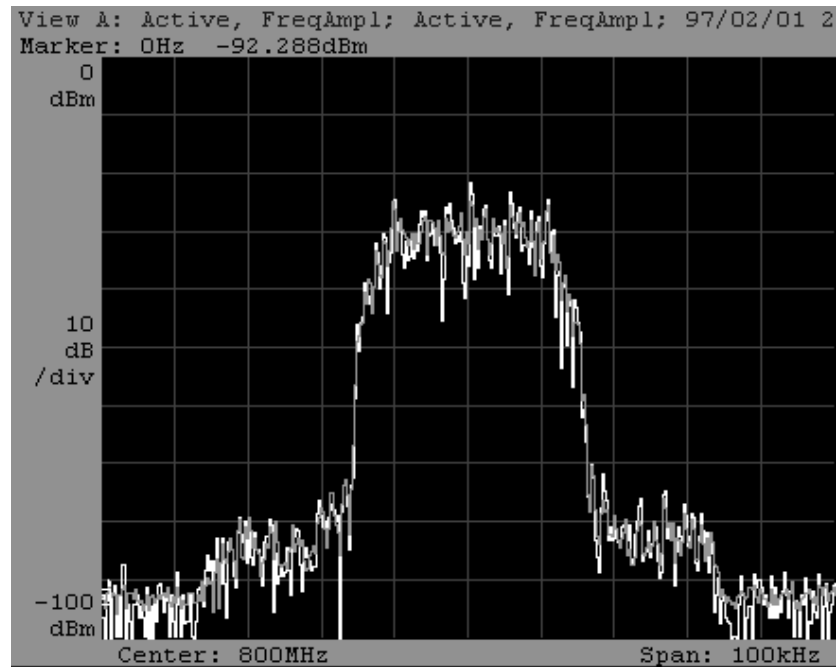

Figure 2-40: Averaging and compared waveform display

Setting Up the Compared Display

You can display two waveforms for comparison.

3. Make settings to display the averaged and the non-averaged waveforms at the same time:
 - a. Return to the previous menu level by pressing the [**View A**]<- side key (top side key).
 - b. Press the side key **Options...** → **Trace2...** → **Source**.
 - c. Select **Active** using the general purpose knob.

View A displays a green and a yellow trace (see Figure 2-40). The white trace represents the non-averaged waveform and the grayish trace the averaged waveform.

Peak Search and Zoom

In this section, you learn to use the peak search and zoom functions.

The zoom expands a specific section of the obtained spectrum and displays it. The analyzer remakes the frequency domain data, with a specific frequency and span, based on the time domain data. Therefore, it is capable of enlarging the view by a factor of up to 1000 without sacrificing the precision of observation.

Setting the Zoom Mode

To expand the display, you must first acquire the waveform in the Zoom mode.

1. Place the analyzer in the Zoom mode:
 - a. Press the **CONFIG:MODE** key.
 - b. Press the **Zoom** side key.

The analyzer is now in the Zoom mode. The center frequency and span settings are still unchanged. Check them with the menu.

2. Press the **SETUP:FREQ** key.

With the Freq and Span menu items, make sure that the center frequency and span settings are 800 MHz and 100 kHz, respectively. If you changed these settings previously, they will not be reset when you change acquisition or display modes. To set them, follow the steps listed on pages 2–28 and 2–30.

Acquiring the Signal

The zoom function requires the Block mode.

3. Press the **BLOCK** key on the front panel to acquire the signal.

Figure 2–41 shows an example of the signal acquired in the Zoom mode.

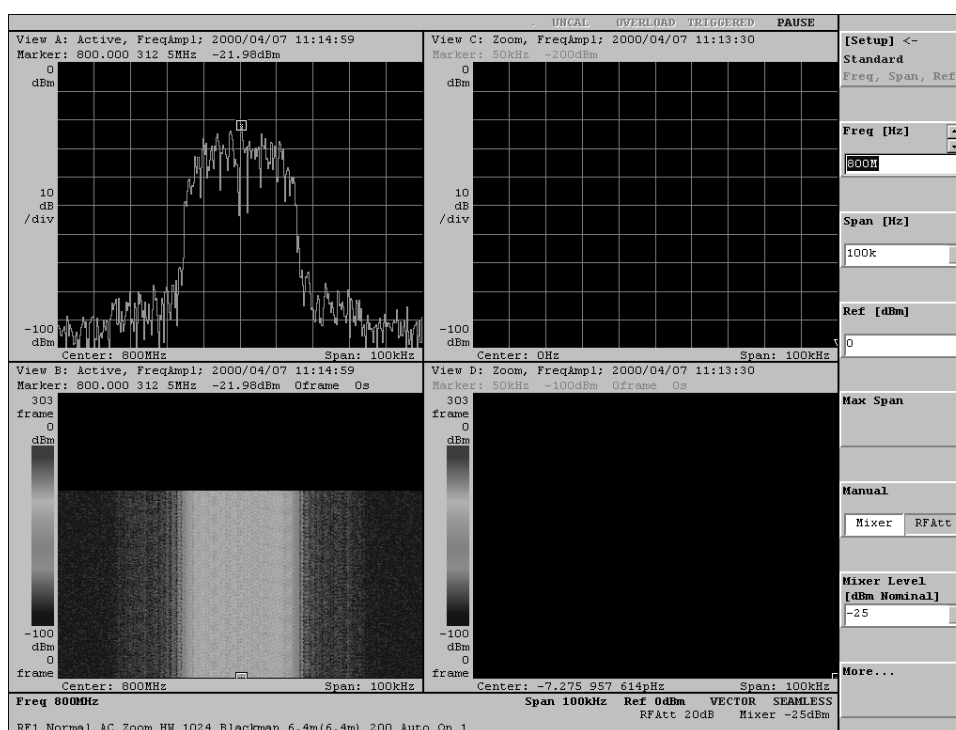

Figure 2–41: Signal acquisition in the Zoom mode

Searching for the Peak

Define a new center frequency and expansion factor for the acquired waveform. Use the search function to search for the peak signal with the maximum intensity and set the peak frequency to the center frequency for zooming.

4. Using the search function, search for the peak spectrum:
 - a. Press the **VIEW:A** key.
 - b. Press the **VIEW:SRCH** key.

The marker (□) is positioned at the maximum signal peak. The marker frequency in View A becomes the center frequency for zooming in View C in the next step.

Executing Zoom

Execute zoom around the center frequency found with the search function.

5. Run zooming:
 - a. Press the **SETUP:MAIN** key.
 - b. Press the **Zoom...** side key.

Note that the Frequency menu item contains the new frequency resulting from the search.

- c. Press the **Mag** side key to set the expansion factor to **100** using the general purpose knob.
- d. Press the **Execute** side key.

The expanded view is displayed in Views C and D as shown in Figure 2–42.

In View D, the number of displayed frames is $[(\text{block size})/(\text{expansion factor}) - 1]$ (In this case, $200/100 - 1 = 1$).

You can repeat steps c and d for different expansion factors.

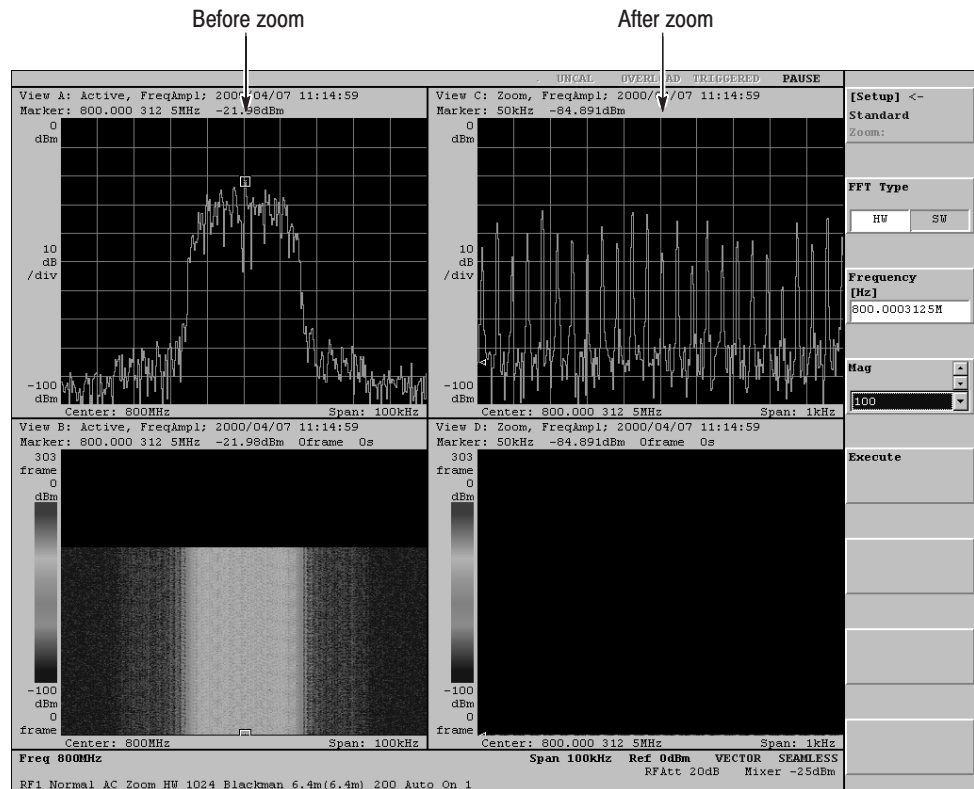



Figure 2–42: Example of zooming

Delta Markers

In this section, you learn how to operate the delta markers. Delta markers let you accurately measure the difference between two frequencies.

A comb spectrum waveform can be observed in View C in Figure 2–43. Measure the difference between the frequencies of adjacent spectrum peaks.

1. For better visibility, change View C to a single view display:
 - a. Press the VIEW:C key.
 - b. Press the VIEW:  key.

View C changes to single view display. See Figure 2–43.

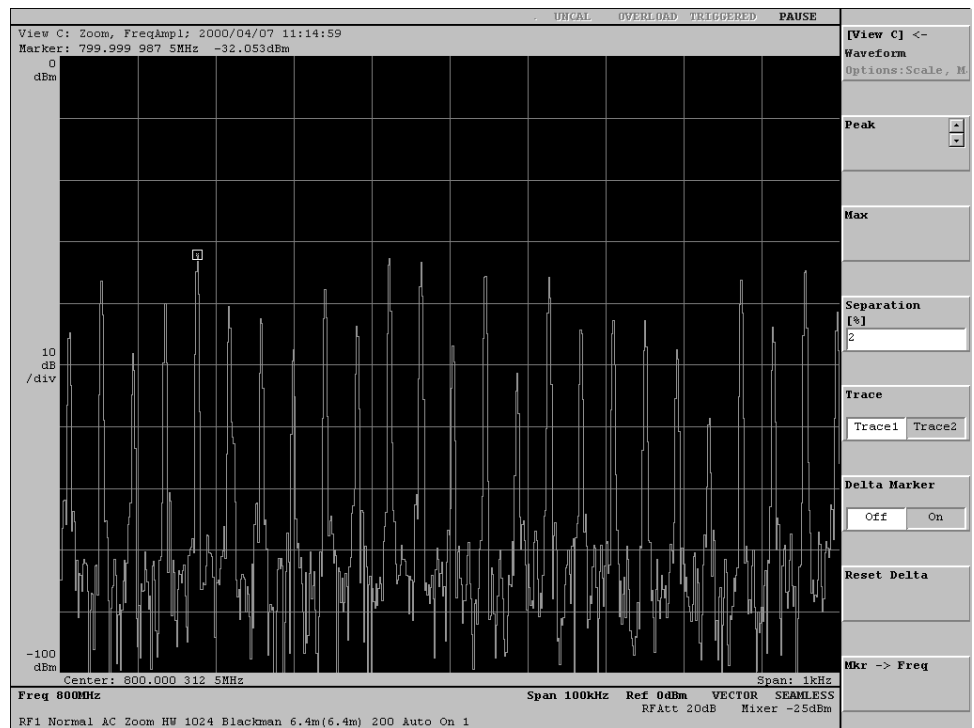

Figure 2–43: Moving the markers by peak search

Searching for the Peak

For example, we measure the interval between the peak spectrum with the maximum power and the adjacent peak to its right.

2. Position the marker at the maximum peak spectrum:

- Press the VIEW:**SRCH** key.

The marker (□) is positioned at the maximum peak spectrum as shown in Figure 2-43.

Operating the Delta Markers

Position the delta markers for a measurement.

3. Operate the delta markers:

- a. Press the VIEW:**MKR** key.
- b. Press the **Delta Marker** side key and select **On**.

The delta markers (□ and ◇) turn on.

4. Measure the frequency interval between two peaks:

By rotating the general purpose knob, move the \square marker to the adjacent right peak.

At the top left corner, the view shows the differences in frequency and power resulting from the delta marker measurement. See Figure 2-44.

Result of delta marker measurement

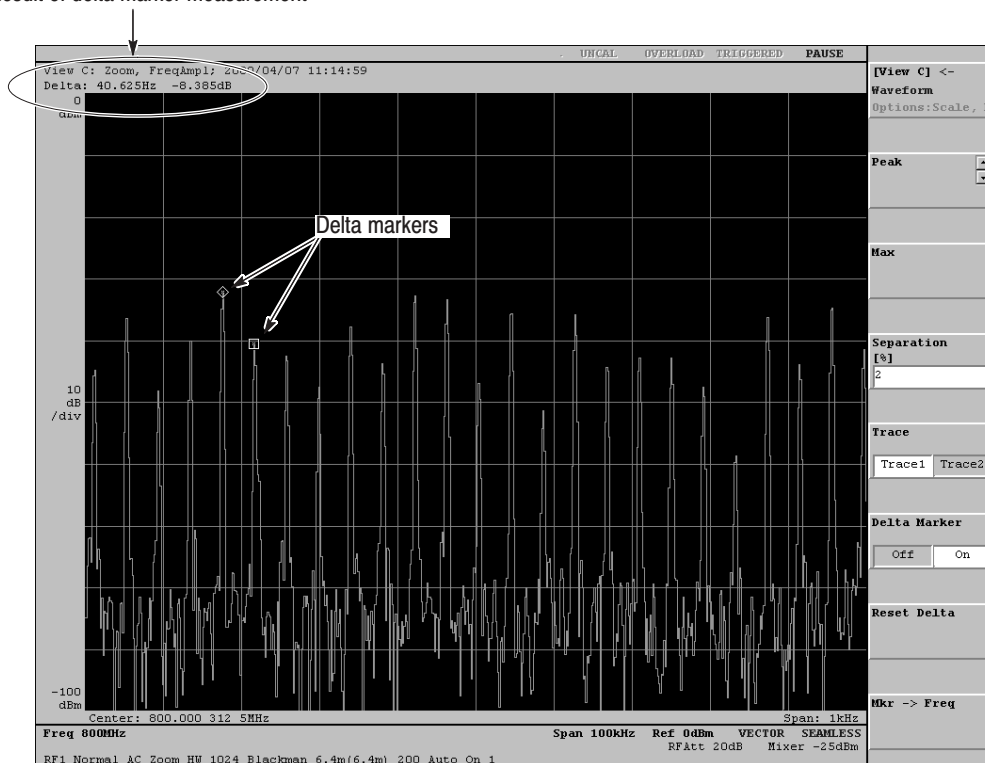

Figure 2-44: Measurement example using the delta markers

Turning Off the Power

After completion of your measurements, turn off the power.

1. Press the power switch at the bottom left corner of the front panel to select the **STANDBY** position.

The Windows 98 shutdown process runs and powers down the analyzer.

2. Turn off the signal generator.

You have completed the tutorial.

Menu Functions

This section provides detailed information on menu functions.

Setup Sequence

When you power on the analyzer, the Windows 98 operating system boots up and the initial screen appears on the display. The analyzer is now ready for measurement.

Figure 2–45 shows the rough flow from signal input to display. It also contains hierarchical representation of the menus associated with the keys on the front panel, and the process blocks that can be operated by the menus.

Use the following procedure to set up or operate the analyzer:

1. Use the **CONFIG:MODE** menu to set up a basic system environment. Several basic setting patterns are predefined. Their icons are displayed in the side keys.
2. You can use the **CONFIG:SETUP** menu to change signal processing modes or the **CONFIG:VIEW** menu to changes display formats or the number of views.
3. Before or during measurement, you can use the **SETUP:MAIN** or **VIEW:MAIN** menu to change detailed settings. For example, you can change frequency, span or display scales. You can also operate markers or create trigger mask patterns.

1. With a basic configuration pattern, make settings for two major categories: signal process modes and views.
2. Adjust the basic configuration pattern as required for a specific application.
3. Analyze the signal while making fine changes to the settings.

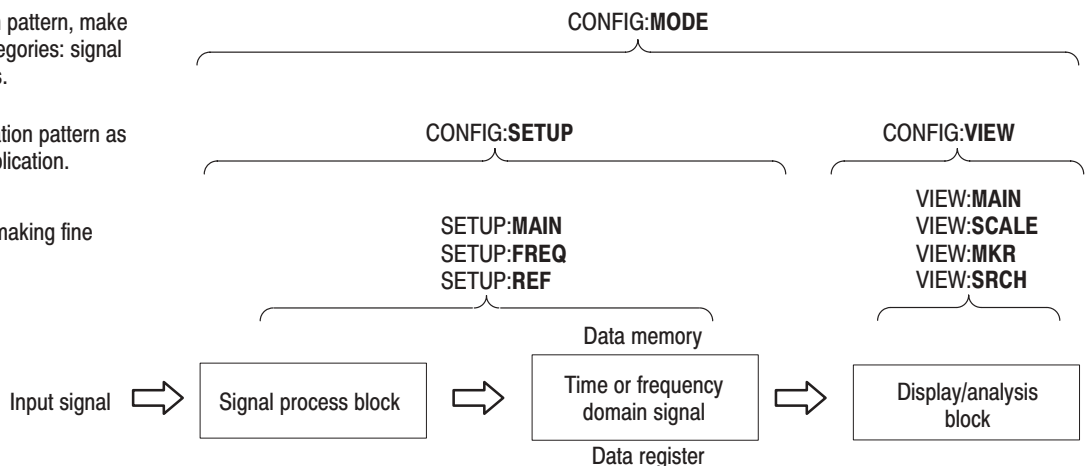

Figure 2–45: Signal process and display blocks

CONFIG Menu

The CONFIG menu configures the analyzer with the predefined basic patterns. You can select the CONFIG menu in the CONFIG area on the front panel.

Table 2-3: CONFIG menu table

Top level	Subordinate level, options and descriptions	
Factory Reset	Reset the current settings to the factory default. To display this menu, press CONFIG:MODE (front panel) → [Config] <- (top side key). <i>NOTE. The settings on the Remote (Util 8) will not be changed.</i>	
Power On...	Loads and saves the power-on settings. The power-on settings are saved in the system file <i>init.cfg</i> . To display this menu, press CONFIG:MODE (front panel) → [Config] <- (top side key).	
	Load From INIT.CFG	Reset the analyzer to the power-on settings. <i>NOTE: The settings on the Remote (Util 8) will not be changed.</i>
	Save To INIT.CFG	Saves the current settings to the system file <i>init.cfg</i> .
	Return To Default	Return the power-on settings to the factory default.
Mode...	The CONFIG:MODE menu allows you to set up signal process and display systems using basic patterns. The analyzer has predefined basic setting patterns used frequently. Their icons are displayed in the side keys. <i>NOTE. The frequency and the span for the basic setting pattern default to 1.5 GHz and 3 GHz respectively. After making a basic setting, set the span to a proper value.</i> For the default values of the basic setting patterns, refer to Appendix C.	
	Load (*.CFG)	Loads the instrument settings from a file and configures the analyzer.
	Save (*.CFG)	Saves the current settings in a specified file. If you save the setting patterns frequently used in a file, you can load them to set up the analyzer when necessary.
	Spectrum	Configures the analyzer for observing spectra.
	Spectrum Spectrogram	Configures the analyzer for observing spectra and spectrograms.
	Dual	Configures the analyzer for the dual (frequency and time) mode. For the dual mode, refer to <i>Memory Mode</i> on page 3-5.
	Zoom	Configures the analyzer for the zoom mode. For the zoom mode, refer to <i>Memory Mode</i> on page 3-5.

Table 2-3: CONFIG menu table (cont.)

Top level	Subordinate level, options and descriptions	
3GPP...	Makes basic settings compliant to the 3GPP (3rd Generation Partnership Project) standard. Choose one of the following:	
	ACP	Performs measurement, analysis, and display of ACP (Adjacent Channel Leak Power).
	Down Link	Performs measurement, analysis, and display of down-link signals.
CCDF	Configures the analyzer for the CCDF (Complementary Cumulative Distribution Function) measurement. Refer to <i>CCDF Analysis</i> on page 3-165.	
CDMA (IS-95 / T-53)	Configures the analyzer for ARIB T-53 and IS-95 standard-compliant CDMA analysis. Select one of the following three:	
	EVM/Rho	Performs measurement, analysis, and display of Error Vector Magnitude (EVM), RHO(ρ meters), frequency errors, and origin offset errors.
	Spurious	Performs measurement, analysis, and display of signal power, OBW, and spurious characteristics.
	Time Domain	Performs measurement, analysis and display of the time characteristics of burst signals.
cdmaOne Fwd Link	Configures the analyzer for analyzing cdmaOne forward link signals. Refer to <i>cdmaOne analysis</i> on page 3-127.	
W-CDMA Down Link	Make basic settings for analyzing W(Wideband)-CDMA down-link signals. Refer to <i>W-CDMA analysis</i> on page 3-135.	
Digital Demod	Configures the analyzer for observing digitally-modulated signals.	
External Sync	<p>Configures the analyzer for the external sync mode. In this mode, the external trigger position is displayed on the time axis with a vertical line marker, allowing you to measure input signal delay relative to the trigger signal.</p> <p>Input the external trigger signal from the EXT TRIG connector on the front panel with TTL level. Trigger occurs on the rising edge of the trigger signal. The external sync mode is available in the Wide IF mode. (For the IF mode, refer to page 3-4).</p> <p>The marker accuracy is as follows: ± 50 ns for 20 MHz and 30 MHz span ± 100 ns for 10 MHz span</p>	
GSM Measurement	Configures the analyzer for the measurements according to the GSM (Global System for Mobile Communication). For details, refer to <i>GSM Analysis</i> on page 3-151.	
Calibration	Executes the auto-calibration. For details, refer to <i>Wide IQ full calibration</i> on page 1-22.	
Diag	Executes the internal diagnostic routines. For details, refer to <i>Diagnosis</i> on page 1-23.	

Table 2-3: CONFIG menu table (cont.)

Top level	Subordinate level, options and descriptions		
Setup...	Loads the predefined standard settings for a center frequency, span, reference level, and trigger.		
	Action	Switches side key functions.	
		Assign	Allows you to select items using the Setup side key.
		Show	Allows you to display the item selected with the Setup side key.
	Setup	Selects the Setup program. The Setup submenu changes according to the selection of a basic setting pattern with the CONFIG:MODE menu. <i>NOTE. Use this setting unchanged in usual operation.</i>	
		None	Prohibits settings with the Setup menu.
		Standard	Configures the analyzer with standard settings. For detailed settings, refer to <i>Setup (standard) Menu</i> on page 2-54.
		CDMA	Configures the analyzer with the settings for CDMA analysis. For detailed settings, refer to <i>Setup (CDMA) Menu</i> on page 2-59.
		3gppACP	Configures the analyzer with the 3GPP (3rd Generation Partnership Project) standard-compliant settings for ACP measurement. For detailed settings, refer to <i>Setup (3gppACP) Menu</i> on page 2-61.
	View...	Determines how to analyze and display data on the screen.	
Action		Switches side key functions.	
		Assign	Allows you to select items using the View A to H side keys.
		Show	Allows you to display the item selected using the View A to H side keys.
View A to H		Selects a display format for each view. To show View E to H menus, press the More... side key. You can choose one of the following display formats. Use each view menu for detailed settings.	
		None	Specifies no waveform is displayed in a view.
		Waveform	Displays a spectrum whose horizontal axis represents frequency or time and vertical axis represents amplitude, phase, I, or Q. For detailed settings, refer to page 2-63. This view has an averaging function for a spectrum waveform. It can also display two waveforms concurrently, which is useful when you observe two waveforms to compare them. It allows measurement of noise and power.
		Analog	Demodulates an AM, FM or PM modulated signal and displays the result. Horizontal axis represents time, and vertical axis frequency (FM), amplitude (AM), or phase (PM). For detailed settings, refer to page 2-69.
		FSK	Demodulates a Frequency Shifting Keying (FSK) modulated signal and displays the result. Horizontal axis represents time, and vertical axis modulating levels, phase, or frequency. For detailed settings, refer to page 2-71.
Spectrogram		Enables frame-by-frame time-series display along the vertical axis. In each spectrum, the horizontal axis represents frequency, amplitude or phase in color. This is called "color spectrogram display". For detailed settings, refer to page 2-72.	

Table 2-3: CONFIG menu table (cont.)

Top level	Subordinate level, options and descriptions	
	Waterfall	Enables frame-by-frame time-series display along the vertical axis. In each spectrum, the horizontal axis represents frequency or time, and the vertical axis amplitude, phase, I, or Q. This is called “waterfall display”. For detailed settings, refer to page 2-75.
	Polar	Displays a demodulated signal in polar coordinates. (The horizontal and vertical axes represent I and Q respectively in rectangular coordinates.) It is used to observe phases and amplitudes of a digitally-modulated signal, and is called “constellation display”. For detailed settings, refer to page 2-76.
	EyeDiagram	Uses the demodulated signal in the Polar view as an input source to display an EYE diagram whose horizontal axis represents frequency or time and vertical axis amplitude, phase, I, or Q. This view must be used together with the Polar view. For detailed settings, refer to page 2-79.
	SymbolTable	Uses the demodulated signal in the Polar view as an input source to display numeric values for a digital pattern. This view must be used together with the Polar view. For detailed settings, refer to page 2-80.
	EVM	Uses the demodulated signal in the Polar view as an input source to display an error vector magnitude for a digitally-modulated signal. This view must be used together with the Polar view. For detailed settings, refer to page 2-81.
	CDMA-related view	
	CDMAWaveform	This view has basically the same functions as the Waveform view except for the ARIB T-53 and IS-95-compliant analysis functions. For detailed settings, refer to page 2-83.
	CDMAPolar	This view has basically the same functions as the Polar view except for the ARIB T-53 and IS-95-compliant analysis functions. For detailed settings, refer to page 2-86.
	CDMATime	The horizontal axis represents time or frequency, and the vertical axis signal levels. This view has the ARIB T-53 and IS-95-compliant functions for spurious measurement and analysis. For detailed settings, refer to page 2-88.
	cdmaOne-related view	
	Code-Spectrogram	This view has basically the same functions as the Spectrogram view except for the cdmaOne-compliant analysis functions. For detailed settings, refer to page 2-90.
	CodePolar	This view has basically the same functions as the Polar view except for the cdmaOne-compliant analysis functions. For detailed settings, refer to page 2-92.
	CodePower	This view has basically the same functions as the Waveform view except for the cdmaOne-compliant analysis functions. For detailed settings, refer to page 2-93.

Table 2-3: CONFIG menu table (cont.)

Top level	Subordinate level, options and descriptions	
	W-CDMA-related view	
	CodeW-Spectrogram	This view has basically the same functions as the Spectrogram view except for the W-CDMA-compliant analysis functions. For detailed settings, refer to page 2-95.
	CodeWPolar	This view has basically the same functions as the Polar view except for the W-CDMA-compliant analysis functions. For detailed settings, refer to page 2-97.
	CodeWPower	This view has basically the same functions as the Waveform view except for the W-CDMA-compliant analysis functions. For detailed settings, refer to page 2-99.
	3GPP-related view	
	3gppACPView	This view has the 3GPP-compliant functions for measuring ACP. For detailed settings, refer to page 2-100.
	3gpp-Spectrogram	This view has basically the same functions as the Spectrogram view except for the 3GPP-compliant analysis. For detailed settings, refer to page 2-103.
	3gppPolar	This view has basically the same functions as the Polar view except for the 3GPP-compliant analysis functions. For detailed settings, refer to page 2-104.
	3gppPower	This view has basically the same functions as the Waveform view except for the 3GPP-compliant analysis functions. For detailed settings, refer to page 2-106.
	GSM-related view	
	GSM	Controls the measurements under the GSM (Global System for Mobile Communication). For detailed settings, refer to page 3-151.
	CCDF-related view	
	CCDF	Performs Complementary Cumulative Distribution Functions (CCDF) measurements. For detailed settings, refer to page 2-112.
	CCDFView	Displays the measurement results of the CCDF view described above. For detailed settings, refer to page 2-114.
	Auto-save-related view	
	AutoSave	Performs the auto-save function that acquires data while storing it to a file. For detailed settings, refer to page 2-115.
	Script-related view	
	Script	The analyzer supports the scripting language. You can create a script program to add and customize side keys or automate measurement. For details, refer to the <i>Programmer Manual</i> .

Table 2-3: CONFIG menu table (cont.)

Top level	Subordinate level, options and descriptions	
	Options...	Configures screens, and sets up background colors and marker link.
	Style	Selects a view layout in the screen. For how to display data, refer to <i>Displaying Waveform Data</i> on page 3-31.
	Background Color	Selects white or black for the screen background color.
	Marker Link	Specifies whether the markers in all views move in unison or separately. If you want to move markers in unison, select On. Otherwise, select Off.
Util...	There are utility menus of A to H. When you press the More... side key, the Util E to H menus appear.	
	Action	Switches side key functions.
	Assign	Allows you to select items using the Util A to H side keys.
	Show	Allows you to display the item selected using the Util A to H side keys.
	Util A [SelfCal]	Displays the Self Calibration menu. For detailed settings, refer to page 2-116. For the calibration procedures, refer to <i>Self Gain-Calibration</i> on page 1-20.
	Util B [SaveLoad]	Loads and saves data to/from a file. For detailed settings, refer to page 2-117.
	Util C [Average]	Displays the Average menu. For detailed settings, refer to page 2-118.
	Util D [Ext Sync]	This function is called when you select External Sync in CONFIG:MODE menu (refer to page 2-48). It is used internally and has no menu selection.
	Util E to G	Displays the menus associated with the side keys of Util E to Util G. The analyzer incorporates no function by factory default.
	Util H [Remote]	Displays the remote control menu. The menu allows you to set up communication parameters between the analyzer and external devices. For details, refer to the <i>Programmer Manual</i> .

SETUP (Standard) Menu

When you select **Standard** with CONFIG:SETUP → **Setup**, pressing the SETUP:MAIN key displays the menu shown in Table 2–4. Use this menu to set input mode, frequency, reference level, trigger, FFT, and other parameters.

Table 2–4: SETUP (standard) menu table

Top level	Subordinate level, options and descriptions		
Band	Selects an input frequency range.		
	Baseband	0 to 10 MHz	
	RF	WCA330 only. 10 MHz to 3 GHz (IF mode: Normal, HiRes) or 50 MHz to 3 GHz (IF mode: Wide)	
	RF1 to RF4	WCA380 only. RF1: 10 MHz to 3 GHz (IF mode: Normal, HiRes) or 50 MHz to 3 GHz (IF mode: Wide) RF2: 2.5 GHz to 3.5 GHz RF3: 3.5 GHz to 6.5 GHz RF4: 5.0 GHz to 8.0 GHz	
	IQ	Processes the I and Q signals input from the I and Q INPUT connectors on the rear panel.	
IF Mode	Selects an Intermediate Frequency (IF) mode. In the Baseband mode, the IF mode is fixed to Normal. In the IQ mode, it is fixed to Wide. For details, refer to <i>Input and Memory Modes</i> on page 3–1.		
	Normal	This mode has an IF bandwidth of 10 MHz and features a high degree of phase flatness. It is suitable for digital modulation analysis with a span below 6 MHz, or general measurement that does not require a wide dynamic range.	
	HiRes	This mode has a relatively narrow IF bandwidth of 6 MHz, but has the widest dynamic range. It is suitable for Adjacent Channel Leak Power (ACP) or spurious measurement.	
	Wide	This mode has an IF bandwidth of 32 MHz, which is the widest of all the three modes. It is suitable for modulation analysis of wide bandwidth signals or code-domain analysis of W-COMA.	
Memory Mode, Input, FFT...	Sets up input coupling, a memory mode, and FFT parameters.		
	Input Coupling	Selects the input coupling for the RF INPUT connector on the front panel. This item is displayed only in the Baseband mode. In the RF mode, the input coupling is fixed to AC. In the IQ mode, AC or DC is selectable.	
		AC	Removes the DC component of an input signal to process only the AC component.
		GND	Displays the ground level.
		DC	Measures an input signal as it is.
	Memory Mode	Selects the memory mode. Refer to <i>Input and Memory Modes</i> on page 3–1 for details.	
		Frequency	Processes data in the frequency domain only.
		Dual	Processes data in both the frequency and time domains.
Zoom		Processes data in both the frequency and time domains, and expand the waveform around a specified center frequency.	

Table 2-4: SETUP (standard) menu table (cont.)

Top level	Subordinate level, options and descriptions	
	FFT Type	Selects HW (hardware) or SW (software) for the FFT processing method. Refer to <i>FFT Parameters</i> on page 3-15 for the details.
	FFT Points	Selects 256 or 1024 for the number of FFT sample points per frame. For 1024 points, the high-resolution mode results. For 256 points, the high-speed measurement mode results. For Dual and Zoom modes, only the 1024 points setting is valid. A frame length also depends on the number of points specified here. For time domain data, this value is also used for sampling. Refer to <i>FFT Parameters</i> on page 3-15 and <i>Frame Period and Real Time</i> on page 3-25 for the details.
	FFT Window	Selects Blackman, Hamming, or Rect for the FFT window. Refer to <i>FFT Parameters</i> on page 3-15 for details.
Freq, Span, Ref...	Sets a center frequency, span, and reference level. The center frequency, span and reference level can be accessed directly using the SETUP:FREQ, SPAN, and REF keys, respectively. <i>NOTE. When you change modes from Baseband to RF, IQ, or Wide, or vice versa, these setting will be changed to the defaults.</i>	
	Freq	Sets a center frequency. You must set the value so that [Frequency \pm (Span/2)] does not exceed the frequency range available for the analyzer. Refer to <i>Frequency and Span</i> on page 3-9 for details.
	Span	3G/2G/1G/500M/200M/100M/50M/30M/20M/10M/6M/5M/2M/1M/500k/200k/100k/50k/20k/10k/5k/2k/1k/500/200/100 Selects a predefined span. This value depends on the input mode: Baseband mode: 100 Hz to 10 MHz in 1-2-5 steps RF mode: 100 Hz to 3 GHz in 1-2-5 steps IQ and Wide modes: 10 MHz, 20 MHz, or 30 MHz If you press the Max Span side key, the maximum span is set. Refer to <i>Frequency and Span</i> on page 3-9 for details.
	Ref	Sets a reference level. It must be greater than the maximum level of an input signal. If an overload occurs, the measured data will be invalid. Refer to <i>Reference Level</i> on page 3-13 for details.
	Max Span	Sets the maximum span.
	Manual	Mixer and RF attenuator levels are usually set automatically. When you want to set these levels manually, select Mixer or RF Att and set the value as described below.
	Mixer Level	When you select Mixer in Manual above, select the level. The mixer level depends on the Band setting: RF (WCA330) / RF1, RF2 (WCA380): -5, -10, -15, -20, -25 dBm RF3, RF4 (WCA380): -5, -15, -25 dBm Select the level necessary for your measurement. The default is -25 dBm. Normally, use the default. If your measurement requires high dynamic range, such as Adjacent Channel Leak Power (ACP) measurement, you can increase the level up to -5 dBm. <i>NOTE. Raising the mixer level increases waveform distortion.</i>

Table 2-4: SETUP (standard) menu table (cont.)

Top level	Subordinate level, options and descriptions	
	RF Att	When you select RF Att in Manual above, select the level. The RF attenuator level depends on the Band setting: RF (WCA330) / RF1, RF2 (WCA380): 0 to 50 dB in 0-2-5-7 step. RF3, RF4 (WCA380): 0, 10, 20, 30, 40, 50 dB
	Freq Offset	The frequency displayed on the screen is the sum of the frequency actually processed by the analyzer and its frequency offset. This setting is required, for example, when a down converter is connected externally. This does not affect the frequency internally processed by the analyzer. Usually, set this value to zero.
	Ref Offset	The reference level displayed on the screen is the sum of the reference level actually processed by the analyzer and its offset. This setting is required, for example, when an attenuator is connected externally. This does not affect the reference level internally processed by the analyzer. Usually, set this value to zero.
	Reference Osc	Selects a reference clock.
	External	When you want the analyzer to operate on the same clock as other devices, use the 10 MHz sine wave between -10 dBm and + 6 dBm input through the 10 MHz REF INPUT connector on the rear panel.
	Internal	The internal reference clock for the analyzer (10 MHz sine wave) is used.
Frame Period	Sets a frame period. The frame period is valid when data is acquired in the block mode with the memory mode set to Frequency or Dual. In the Zoom mode, this setting is ignored and is not displayed as a menu item because the frame period is so set that frames are continuous in the temporal aspect. For details on the frame period, refer to page 3-25.	
Block Size	Specifies the number of frames when data is acquired in the block mode. When you press the BLOCK key, data is acquired in frames for the block size specified here and then displayed. Refer to <i>Setting the Block Size</i> on page 3-22 for details.	
Trigger...	Sets up a trigger. The trigger function is available only for the Block mode. In the Roll mode, this setting is ignored and data is acquired continuously. Refer to <i>Trigger</i> on page 3-65 for details.	
	Mode	Selects the trigger mode. The analyzer has the following trigger modes:
	Auto	Data is acquired under the following conditions regardless of trigger generation. If you turn on the trigger count, when you press the BLOCK key on the front panel, data is acquired the number of times specified with the trigger count (Times). Otherwise, data acquisition is repeated until you press the BLOCK key on the front panel again.
	Normal	When a trigger is generated, data is acquired. When you press the BLOCK key on the front panel with the trigger count on, data is acquired the number of times specified with the trigger count (Times) after a trigger is generated. Otherwise, data acquisition is repeated while waiting for trigger generation until you press the BLOCK key on the front panel again.

Table 2-4: SETUP (standard) menu table (cont.)

Top level	Subordinate level, options and descriptions	
	Quick	Same as Normal except that data is displayed after all blocks are acquired.
	Delayed	Same as Normal except that data acquisition completes at the time specified with Delayed (refer to page 2-57) after trigger event generation.
	Timeout	This mode is valid when the trigger source is set to Internal. When a trigger event does not occur within the time specified with Timeout (refer to page 2-57), data acquisition stops. If a signal suddenly disappears when the trigger mode is set to Timeout, you can examine the contents of data just before the signal disappears.
	Interval	Block data is acquired at a specified interval. The interval is set with the Interval menu item (see below).
	Quick Interval	Same as Quick except that data is displayed after all blocks are acquired.
	Never	You can start or stop data acquisition of one block manually by pressing the BLOCK key. Other trigger settings are ineffective.
Count	Sets the trigger count on (enabled) or off (disabled). The trigger count is specified with Times.	
Times	Sets a trigger count. If Count is set to on, data is acquired the number of times specified here. Refer to <i>Trigger Count</i> on page 3-70 for details.	
Source	Selects a trigger source. Refer to <i>Trigger Source</i> on page 3-73 for details.	
	Internal	A trigger mask pattern is used to generate a trigger.
	External	A trigger is generated by the rising edge of a signal input through the EXT TRIG connector on the front panel.
Domain	Specifies the domain in which a trigger functions. Select either Frequency (frequency domain) or Time (time domain). Refer to <i>Trigger Domain</i> on page 3-73 for details.	
Slope	Selects a trigger polarity when the trigger source is set to Internal. Refer to <i>Trigger Slope</i> on page 3-73 for details.	
	Rise	When a signal exits the trigger mask pattern area, that is, when a signal exits the blue area and enters the black area (assuming that screen colors are set to the defaults), a trigger occurs.
	Fall	When a signal enters the trigger mask pattern area, that is, when a signal exits the black area and enters the blue area (assuming that screen colors are set to the defaults), a trigger occurs.
Pos	Specifies a trigger position between 0 % and 100 % in 1 % steps. The trigger position represents the rate of the number of frames acquired before the trigger generation to that of frames contained in one block. For example, if one block contains 1000 frames and the trigger position is 10 %, 100 frames are acquired before trigger generation and 900 frames are acquired after trigger generation. Refer to <i>Trigger Position</i> on page 3-74 for details.	
Delayed	Sets the delay time when the trigger mode is set to Delayed. The range is 0 to 60 s.	
Timeout	Sets the timeout value when the trigger mode is set to Timeout. The range is 0 to 60 s.	
Interval	Sets the time interval when the trigger mode is set to Interval or Quick Interval. The range is 1 to 3600 s.	

Table 2-4: SETUP (standard) menu table (cont.)

Top level	Subordinate level, options and descriptions		
Zoom...	This submenu is displayed only when the zoom mode is set. Zoom is a function to enlarge frequency for a waveform around the center frequency. Refer to <i>Zoom</i> on page 3-51 for details.		
	<table border="1"> <tr> <td data-bbox="313 468 505 541">FFT Type</td> <td data-bbox="505 468 1459 541">Selects HW (hardware) or SW (software) for the FFT processing method. Same as FFT Type on page 2-55.</td> </tr> </table>	FFT Type	Selects HW (hardware) or SW (software) for the FFT processing method. Same as FFT Type on page 2-55.
FFT Type	Selects HW (hardware) or SW (software) for the FFT processing method. Same as FFT Type on page 2-55.		
	<table border="1"> <tr> <td data-bbox="313 541 505 615">FFT Window</td> <td data-bbox="505 541 1459 615">Selects Blackman, Hamming, or Rect for the FFT window. Same as FFT Window on page 2-55.</td> </tr> </table>	FFT Window	Selects Blackman, Hamming, or Rect for the FFT window. Same as FFT Window on page 2-55.
FFT Window	Selects Blackman, Hamming, or Rect for the FFT window. Same as FFT Window on page 2-55.		
	<table border="1"> <tr> <td data-bbox="313 615 505 720">Frequency</td> <td data-bbox="505 615 1459 720">Sets the center frequency for zoom. This value must be within the frequency range of the acquired data. You can also set the central frequency using the Option... → Marker → Mkr-→Freq side key in the view menus shown in page 2-63 and the subsequent pages.</td> </tr> </table>	Frequency	Sets the center frequency for zoom. This value must be within the frequency range of the acquired data. You can also set the central frequency using the Option... → Marker → Mkr-→Freq side key in the view menus shown in page 2-63 and the subsequent pages.
Frequency	Sets the center frequency for zoom. This value must be within the frequency range of the acquired data. You can also set the central frequency using the Option... → Marker → Mkr-→Freq side key in the view menus shown in page 2-63 and the subsequent pages.		
	<table border="1"> <tr> <td data-bbox="313 720 505 842">Mag</td> <td data-bbox="505 720 1459 842">Selects the expansion factor: 5 MHz span: 2/5/10/20/50/100/200/500/1000 Other than 5 MHz span: 2/4/10/20/40/100/200/400/1000</td> </tr> </table>	Mag	Selects the expansion factor: 5 MHz span: 2/5/10/20/50/100/200/500/1000 Other than 5 MHz span: 2/4/10/20/40/100/200/400/1000
Mag	Selects the expansion factor: 5 MHz span: 2/5/10/20/50/100/200/500/1000 Other than 5 MHz span: 2/4/10/20/40/100/200/400/1000		
	<table border="1"> <tr> <td data-bbox="313 842 505 877">Execute</td> <td data-bbox="505 842 1459 877">Executes zoom. You can repeat execution while changing the above settings.</td> </tr> </table>	Execute	Executes zoom. You can repeat execution while changing the above settings.
Execute	Executes zoom. You can repeat execution while changing the above settings.		

SETUP (CDMA) Menu

When you select **CDMA** with **CONFIG:SETUP** → **Setup**, pressing the **SETUP:MAIN** key displays the menu shown in Table 2–5. Use this menu to set input mode, frequency, reference level, trigger, FFT, and other parameters.

Table 2–5: SETUP (CDMA) menu table

Top level	Subordinate level, options and descriptions	
Freq, Span, Ref...	Sets a standard, channel, span, and reference level. The channel, span, and reference level can be accessed directly using the SETUP:FREQ, SPAN, and REF keys, respectively. <i>NOTE. When you change modes from Baseband to RF, IQ, or Wide, or vice versa, these setting will be changed to the defaults.</i>	
	Standard	Selects either the IS-95 or T-53 standard.
	Channel	Selects a channel number to set the measurement frequency. The frequency specified here becomes the center frequency for the 5 MHz span setting, but not for the 30 MHz span (IS-95) or 50 MHz span (T-53). For IS-95, you can select 1 to 777 for the channel number. Channels 1 and 777 correspond to 825.03 and 848.31 MHz, respectively. The frequency difference between two adjacent channels is 0.03 MHz. For T-53, you can select 1 to 1199 for the channel number. Channels 1 and 1199 correspond to 915.0125 and 888.9875 MHz, respectively. The frequency difference between two adjacent channels is 0.0125 MHz.
	Span	3G/2G/1G/500M/ 200M/100M/50M/ /30M/20M/10M/ 6M/5M/2M/1M/ 500k/200k/100k/ 50k/20k/10k/ 5k/2k/1k/ 500/200/100 Selects a predefined span. This value depends on the input mode: Baseband mode: 100 Hz to 10 MHz in 1-2-5 steps RF mode: 100 Hz to 3 GHz in 1-2-5 steps IQ and Wide modes: 10 MHz, 20 MHz, or 30 MHz If you press the Max Span side key, the maximum span is set. Refer to <i>Frequency and Span</i> on page 3–9 for details.
	Ref	Sets a reference level. It must be greater than the maximum level of an input signal. If an overload occurs, the measured data will be invalid. Refer to <i>Reference Level</i> on page 3–13 for details.
	Max Span	Sets the maximum span.
	Reference Osc	Selects Internal or External for the reference clock. Same as Reference Osc in SETUP (Standard) menu on page 2–56.

Table 2-5: SETUP (CDMA) menu table (cont.)

Top level	Subordinate level, options and descriptions
30MHz Span	Sets the span to 30 MHz when Standard is IS-95.
50MHz Span	Sets the span to 50 MHz when Standard is T-53.
5MHz Span Auto Trig.	Sets the span to 5 MHz and the trigger mode to Auto. It is useful to observe a continuous wave.
5MHz Span Normal Trig.	Sets the span to 5 MHz and the trigger mode to Normal. It is useful to observe a burst signal.
Block Size	Specifies the number of frames when data is acquired in the block mode. When you press the BLOCK key, data is acquired in frames for the block size specified here and then displayed. Refer to <i>Setting the Block Size</i> on page 3-22.
Trigger...	Sets the trigger parameters. Same as Trigger... in the SETUP (Standard) menu on page 2-56. Refer to <i>Trigger</i> on page 3-65 for details.
Trigger Level	Sets the trigger level in the time domain when you have selected 5 MHz Span Normal Trig. The range is -40 dB to 0 dB.

SETUP (3gppACP) Menu

When you select **3gppACP** with **CONFIG:SETUP** → **Setup**, pressing the **SETUP:MAIN** key displays the menu shown in Table 2–6. Use this menu to set input mode, frequency, reference level, FFT, and other parameters for the ACP measurement under the 3GPP standard.

Table 2–6: SETUP (3gppACP) menu table

Top level	Subordinate level, options and descriptions	
Band	Selects an input frequency range.	
	RF	WCA330 only. 10 MHz to 3 GHz (IF mode: Normal, HiRes) or 50 MHz to 3 GHz (IF mode: Wide)
	RF1 to RF4	WCA380 only. RF1: 10 MHz to 3 GHz (IF mode: Normal, HiRes) or 50 MHz to 3 GHz (IF mode: Wide) RF2: 2.5 GHz to 3.5 GHz RF3: 3.5 GHz to 6.5 GHz RF4: 5.0 GHz to 8.0 GHz
IF Mode	Selects an Intermediate Frequency (IF) mode. In the Baseband mode, the IF mode is fixed to Normal. For details, refer to <i>Input and Memory Modes</i> on page 3–1.	
	Normal	This mode has an IF bandwidth of 10 MHz and features a high degree of phase flatness. It is suitable for digital modulation analysis with a span below 6 MHz, or general measurement that does not require a wide dynamic range.
	HiRes	This mode has a relatively narrow IF bandwidth of 6 MHz, but has the widest dynamic range. It is suitable for Adjacent Channel Leak Power (ACP) or spurious measurement.
Memory Mode, Input, FFT...	Sets up input coupling, a memory mode, and FFT parameters. Same as Memory Mode, Input, FFT... in SETUP (Standard) menu on page 2–54.	
Freq, Span, Ref...	Sets a center frequency, span, and reference level. The center frequency, span, and reference level can be accessed directly using the SETUP:FREQ, SPAN, and REF keys, respectively. <i>NOTE. When you change modes from Baseband to RF, IQ, or Wide, or vice versa, these setting will be changed to the defaults.</i>	
	Freq	Sets a center frequency. You must set the value so that $[\text{Frequency} \pm (\text{Span}/2)]$ does not exceed the frequency range available for the analyzer. Refer to <i>Frequency and Span</i> on page 3–9 for details.
	Span	30M/15M Selects a predefined span, 30 MHz or 15 MHz.
	Ref	Sets a reference level. It must be greater than the maximum level of an input signal. If an overload occurs, the measured data will be invalid. Refer to <i>Reference Level</i> on page 3–13 for details.

Table 2-6: SETUP (3gppACP) menu table (cont.)

Top level	Subordinate level, options and descriptions	
	Carrier Width	Sets the carrier bandwidth. The range is 1 MHz to 10 MHz. The IF filter is not applied within the specified range.
	Manual	Mixer and RF attenuator levels are usually set automatically. When you want to set these levels manually, select Mixer or RF Att and set the value as described below.
	Mixer Level	When you select Mixer in Manual above, select the level. The mixer level depends on the Band setting: RF (WCA330) / RF1, RF2 (WCA380): -5, -10, -15, -20, -25 dBm RF3, RF4 (WCA380): -5, -15, -25 dBm Select the level necessary for your measurement. The default is -25 dBm. Normally, use the default. If your measurement requires high dynamic range, such as Adjacent Channel Leak Power (ACP) measurement, you can increase the level up to -5 dBm. <i>NOTE. Raising the mixer level increases waveform distortion.</i>
	RF Att	When you select RF Att in Manual above, select the level. The RF attenuator level depends on the Band setting: RF (WCA330) / RF1, RF2 (WCA380): 0 to 50 dB in 0-2-5-7 step. RF3, RF4 (WCA380): 0, 10, 20, 30, 40, 50 dB
	Freq Offset	The frequency displayed on the screen is the sum of the frequency actually processed by the analyzer and its frequency offset. This setting is required, for example, when a down converter is connected externally. This does not affect the frequency internally processed by the analyzer. Usually, set this value to zero.
	Ref Offset	The reference level displayed on the screen is the sum of the reference level actually processed by the analyzer and its offset. This setting is required, for example, when an attenuator is connected externally. This does not affect the reference level internally processed by the analyzer. Usually, set this value to zero.
	Reference Osc	Selects a reference clock.
	External	When you want the analyzer to operate on the same clock as other devices, use the 10 MHz sine wave between -10 dBm and +6 dBm input through the 10 MHz REF INPUT connector on the rear panel.
	Internal	The internal reference clock for the analyzer (10 MHz sine wave) is used.

Waveform View Menu

Table 2–7 summarizes the view menu when you have defined the view as Waveform in the CONFIG:VIEW menu.

Table 2–7: Waveform view menu table

Top level	Subordinate level, options and descriptions	
Source	Selects input data for a view. You can select one of the following items:	
	None	Specifies no input source. The display area in the view is empty.
	Active	Specifies the data memory storing acquired data for the input source.
	Zoom	Specifies the zoomed data for an input source. When you use the Zoom mode, select this. For zoom, refer to <i>Input and Memory Modes</i> on page 3–1 and <i>Zoom</i> on page 3–51.
	D1D2 to D7D8	Specifies a register pair for an input source. The digitally-modulated signal demodulated in the Polar view is written into the register pair. To display the spectrum of a demodulated digitally-modulated signal, use a register pair as the input signal. For demodulation of digitally-modulated signals, refer to <i>Display and Analysis of a Digitally-Modulated Signal</i> on page 3–97.
	D1 to D8	Specifies one of the data registers of D1 to D8 for an input source. Copy data to this register using Options... → Copy To... in other view menus or Util C [Average] on a utility menu.
	File (*.IQ)	Specifies the IQ-formatted data file for the input source. On accessing files, refer to <i>File Access Menu</i> on page 2–119.
	File (*.AP)	Specifies the AP-formatted data file for the input source. On accessing files, refer to <i>File Access Menu</i> on page 2–119.
Compression	Generally, as the horizontal number of pixels is smaller than the number of bins, bin data is thinned out in agree with the number of pixels on the screen when it is displayed. This item allows you to select a compression method. This item affects only data display, and appears only when you select a register of D1 to D8 for Source. For compressing display data, refer to <i>Relationship among Frames, Bins, and Pixels</i> on page 3–41.	
	Sample	Samples data at a regular interval to display it.
	MinMax	Selects the maximum and minimum values from the data for each pixel and connect the values with a line.
	Max	Displays the maximum value of the data for each pixel.
	Min	Displays the minimum value of the data for each pixel.

Table 2-7: Waveform view menu table (cont.)

Top level	Subordinate level, options and descriptions		
Format	Defines the horizontal and vertical axes. You can select one of the following items:		
	FreqAmpl	Horizontal axis: Frequency (span) Vertical axis: Amplitude	
	FreqPhase	Horizontal axis: Frequency (span) Vertical axis: Phase	
	FreqI	Horizontal axis: Frequency (span) Vertical axis: I (In-Phase)	
	FreqQ	Horizontal axis: Frequency (span) Vertical axis: Q (Quadrature-Phase)	
	TimeAmpl	Horizontal axis: Time Vertical axis: Amplitude	
	TimePhase	Horizontal axis: Time Vertical axis: Phase	
	TimeI	Horizontal axis: Time Vertical axis: I (In-Phase)	
	TimeQ	Horizontal axis: Time Vertical axis: Q (Quadrature-Phase)	
Frame	<p>Specifies the number of the frame to be displayed. By default, it is set to frame 0 into which the current data is written.</p> <p>If you select Average for the above Source, frame selection is meaningless. This item disappears from the menu.</p>		
Average...	Sets up Average parameters. For details on averaging, refer to <i>Average and Peak Hold</i> on page 3-57.		
	Average	Selects on or off for the average function.	
		Off	Displays raw data without averaging.
		On	In the Roll mode, it performs averaging while acquiring the data. In the Block mode, it displays raw data without averaging. For averaging in the Block mode, use Execute below.
	Average Type	RMSExpo	Performs averaging using exponential Root Mean Square (RMS). This average type decreases the influence of the weighted old data on an average exponentially.
		RMS	Performs averaging using RMS values.
		PeakHold	Holds peak values of the waveform.
	Num Averages	<p>Specifies the number of frames to be averaged. If Average Type is set to RMS, frames specified with Num Averages are averaged before switching to a fixed display. If Average Type is set to RMSExpo, Num Averages is used for weighing old data.</p>	
	Begin Frame	Specifies the first frame for averaging with Execute below.	
	End Frame	Specifies the last frame for averaging with Execute below.	
Mkr -> Frame	Sets the range of frames to be averaged using Execute between the marker and delta marker. This range is applied to Begin Frame and End Frame .		
Execute	Averages the data written in memory in the Roll or Block mode. This item does not depend on the settings of Average On/Off.		
Reset	Restarts the averaging that has been started with Average On .		

Table 2-7: Waveform view menu table (cont.)

Top level	Subordinate level, options and descriptions		
RBW...	Simulates Resolution Bandwidth (RBW) for compatibility with data measured by a conventional scanning RF spectrum analyzer.		
	RBW Calculation	Selecting On performs the calculation.	
	Alpha	Sets the RBW filter shape factor. The range is 0.0001 to 1.	
	RBW	Sets the resolution bandwidth. The range is 4.5 bins to 3 MHz.	
Edit...	Creates a trigger mask pattern in a waveform display. For details on how to create it, refer to page 3-75. To create a trigger mask pattern, □ and ◇ markers are used. You can use Hor., Ver., and Toggle Delta to operate these markers. The created mask pattern is saved in an internal trigger register.		
	Hor.	Specifies a horizontal position to which you moves the □ marker.	
	Ver.	Specifies a vertical position to which you moves the □ marker.	
	Toggle Delta	Changes the □ and ◇ marker positions each other.	
	Draw Max	Fills the area below the maximum line (reference level).	
	Draw Line	Fills the area below the draw line currently set and the line between □ and ◇. The draw line is set using Draw Max or Draw Min .	
	Draw Min	Fills the area below the minimum line (the level below the reference level by 70 dB).	
	Draw Horizontal	Fills the area below the horizontal line including a marker position.	
Options...	Display Lines...	Controls the horizontal and vertical line markers.	
		Hor. 1 Visible	Turns on or off the horizontal line marker 1.
		Hor. 1	Sets the position of the horizontal line marker 1.
		Hor. 2 Visible	Turns on or off the horizontal line marker 2.
		Hor. 2	Sets the position of the horizontal line marker 2.
		Hor. 2 - Hor. 1	Shows the difference between the horizontal line marker 1 and 2.
		Ver. 1 Visible	Turns on or off the vertical line marker 1.
		Ver. 1	Sets the position of the vertical line marker 1.
		Ver. 2 Visible	Turns on or off the vertical line marker 2.
		Ver. 2	Sets the position of the vertical line marker 2.
	Ver. 2 - Ver. 1	Shows the difference between the vertical line marker 1 and 2.	
	Trace2...	Used to display two waveforms concurrently. The Trace2... submenu sets up the second waveform.	
		Source	Same as Source on page 2-63.
		Format	Same as Format on page 2-64.
Frame		Same as Frame on page 2-64.	

Table 2-7: Waveform view menu table (cont.)

Top level	Subordinate level, options and descriptions	
	Copy To...	Copies the waveform currently being displayed to one of the following destinations. This copy function is available only for the data acquired in the vector mode.
		Clipboard Converts the waveform currently being displayed into the text form to copy it to the Windows clipboard. The text data on the clipboard can be passed to PC applications. For details, refer to page 3-206.
		Text File Converts the waveform currently being displayed into the text form to copy it to a text file. For details, refer to page 3-206.
		D1 to D8 Selects a data register in which the waveform currently being displayed is saved temporarily.
	Copy From...	Loads text data from the file to which the waveform was copied using Copy To... This menu item is displayed only when you select a register of D1 to D8 for Source.
	Position	Specifies the number of the frame to be displayed after a trigger event. If this frame number agrees with the trigger position specified with Setup → Trigger... → Pos, the frame for which a trigger is generated is displayed. By default, Position is set to zero (current frame).
	Hold Ver. Scale	Specifies whether you retain or reset the scale setting of the vertical axis when you change the input source.
		On Retains the scale setting of the vertical axis.
		Off Resets the scale setting of the vertical axis. The full-scale display results.
Scale, Marker, Search	Sets up scale-, marker-, and search-related parameters.	
	Scale...	Sets up the horizontal and vertical axes.
		Hor. Scale Sets the horizontal axis scale.
		Hor. Start Sets the horizontal axis start value.
		Ver. Scale Sets the vertical axis scale.
		Ver. Start Sets the vertical axis start value.
		Full Scale Sets the vertical axis to the default full-scale. This menu item is available when Format is FreqAmpl, FreqPhase, TimeAmpl, or TimePhase.
		Auto Scale Automatically sets the start value and scale of the horizontal and vertical axes so that the entire waveform can be displayed. This menu item is available when Format is FreqI, FreqQ, TimeI, or TimeQ.
Frame Relative Specifies whether the origin of the time axis for each frame is set to zero. See Figure 2-46 on page 2-68. <i>On</i> specifies that the origin of the time axis for each frame is set to zero. <i>Off</i> uses the ordinary time axis.		

Table 2-7: Waveform view menu table (cont.)

Top level	Subordinate level, options and descriptions																			
		<p>Marker... Operates the marker and the delta marker. The marker is represented as □, and the delta marker as □ and ◇. For how to use the markers, refer to page 3-45.</p> <table border="1" data-bbox="737 499 1498 1417"> <tr> <td data-bbox="737 499 927 598">Hor.</td> <td data-bbox="927 499 1498 598">Specifies the horizontal position to which you move □. By default, □ is positioned at the start point of the horizontal axis.</td> </tr> <tr> <td data-bbox="737 598 927 697">Trace</td> <td data-bbox="927 598 1498 697">Selects either Trace1 or Trace2 for the waveform you operate with the marker. Trace2 indicates the waveform selected with the Source → Trace2... submenu.</td> </tr> <tr> <td data-bbox="737 697 927 745">Delta Marker</td> <td data-bbox="927 697 1498 745">Turns the delta marker on or off.</td> </tr> <tr> <td data-bbox="737 745 927 793">Toggle Delta</td> <td data-bbox="927 745 1498 793">Changes the □ and ◇ marker positions each other.</td> </tr> <tr> <td data-bbox="737 793 927 947">Mkr→Freq</td> <td data-bbox="927 793 1498 947">Sets the center frequency to the value at the current marker position. When you press this side key, the Freq, Span, Ref... → Freq setting in the SETUP menu changes to the frequency at the current marker position.</td> </tr> <tr> <td data-bbox="737 947 927 1052">Measurement</td> <td data-bbox="927 947 1498 1052">Performs power measurement. Select one of the measurement types: Noise, Power, C/N, C/No, ACP and OBW. Refer to <i>Power Measurement</i> on page 3-81.</td> </tr> <tr> <td data-bbox="737 1052 927 1213">Band Power Markers...</td> <td data-bbox="927 1052 1498 1213">This menu item is displayed when you select Power, C/N, or C/No for Measurement. You can operate the band power marker required for these types of measurement. For how to operate markers, refer to page 3-45.</td> </tr> <tr> <td data-bbox="737 1213 927 1318">ACP...</td> <td data-bbox="927 1213 1498 1318">This menu item is displayed when you select ACP for Measurement. This marker is ACP measurement-specific. For how to operate markers, refer to page 3-45.</td> </tr> <tr> <td data-bbox="737 1318 927 1417">OBW</td> <td data-bbox="927 1318 1498 1417">This menu item is displayed when you select OBW for Measurement. Set the ratio of the power in the specified band region to the power in the entire span region.</td> </tr> </table>	Hor.	Specifies the horizontal position to which you move □. By default, □ is positioned at the start point of the horizontal axis.	Trace	Selects either Trace1 or Trace2 for the waveform you operate with the marker. Trace2 indicates the waveform selected with the Source → Trace2... submenu.	Delta Marker	Turns the delta marker on or off.	Toggle Delta	Changes the □ and ◇ marker positions each other.	Mkr→Freq	Sets the center frequency to the value at the current marker position. When you press this side key, the Freq, Span, Ref... → Freq setting in the SETUP menu changes to the frequency at the current marker position.	Measurement	Performs power measurement. Select one of the measurement types: Noise, Power, C/N, C/No, ACP and OBW. Refer to <i>Power Measurement</i> on page 3-81.	Band Power Markers...	This menu item is displayed when you select Power, C/N, or C/No for Measurement. You can operate the band power marker required for these types of measurement. For how to operate markers, refer to page 3-45.	ACP...	This menu item is displayed when you select ACP for Measurement. This marker is ACP measurement-specific. For how to operate markers, refer to page 3-45.	OBW	This menu item is displayed when you select OBW for Measurement. Set the ratio of the power in the specified band region to the power in the entire span region.
Hor.	Specifies the horizontal position to which you move □. By default, □ is positioned at the start point of the horizontal axis.																			
Trace	Selects either Trace1 or Trace2 for the waveform you operate with the marker. Trace2 indicates the waveform selected with the Source → Trace2... submenu.																			
Delta Marker	Turns the delta marker on or off.																			
Toggle Delta	Changes the □ and ◇ marker positions each other.																			
Mkr→Freq	Sets the center frequency to the value at the current marker position. When you press this side key, the Freq, Span, Ref... → Freq setting in the SETUP menu changes to the frequency at the current marker position.																			
Measurement	Performs power measurement. Select one of the measurement types: Noise, Power, C/N, C/No, ACP and OBW. Refer to <i>Power Measurement</i> on page 3-81.																			
Band Power Markers...	This menu item is displayed when you select Power, C/N, or C/No for Measurement. You can operate the band power marker required for these types of measurement. For how to operate markers, refer to page 3-45.																			
ACP...	This menu item is displayed when you select ACP for Measurement. This marker is ACP measurement-specific. For how to operate markers, refer to page 3-45.																			
OBW	This menu item is displayed when you select OBW for Measurement. Set the ratio of the power in the specified band region to the power in the entire span region.																			
		<p>Search... Searches for the peak spectrum and places the □ marker there.</p> <table border="1" data-bbox="737 1465 1498 1732"> <tr> <td data-bbox="737 1465 927 1564">Peak</td> <td data-bbox="927 1465 1498 1564">Searches the peak spectrum and moves the □ marker there. Rotate the general purpose knob clockwise to search the peak rightward, and vice versa.</td> </tr> <tr> <td data-bbox="737 1564 927 1633">Max</td> <td data-bbox="927 1564 1498 1633">Searches for the maximum peak spectrum and moves the □ marker there.</td> </tr> <tr> <td data-bbox="737 1633 927 1732">Min</td> <td data-bbox="927 1633 1498 1732">Searches for the minimum peak spectrum and moves the □ marker there. This item is available when Format is other than FreqAmpl.</td> </tr> </table>	Peak	Searches the peak spectrum and moves the □ marker there. Rotate the general purpose knob clockwise to search the peak rightward, and vice versa.	Max	Searches for the maximum peak spectrum and moves the □ marker there.	Min	Searches for the minimum peak spectrum and moves the □ marker there. This item is available when Format is other than FreqAmpl.												
Peak	Searches the peak spectrum and moves the □ marker there. Rotate the general purpose knob clockwise to search the peak rightward, and vice versa.																			
Max	Searches for the maximum peak spectrum and moves the □ marker there.																			
Min	Searches for the minimum peak spectrum and moves the □ marker there. This item is available when Format is other than FreqAmpl.																			

Table 2-7: Waveform view menu table (cont.)

Top level	Subordinate level, options and descriptions		
		Separation	Sets the minimum horizontal distance to separate two peaks. The range is 0 to 10 % (full scale = 100%). When you set Separation to, say, 10, if the distance between the two peaks accounts for 10 % or more of the full scale, these peaks are recognized as separate. See Figure 2-47 below.
		Trace	Selects either Trace 1 or Trace 2 for the waveform you operate with a marker. Trace 2 specifies the waveform selected in the Source → Trace2... submenu.
		Delta Marker	Turns the delta marker on or off.
		Toggle Delta	Changes the □ and ◇ marker positions each other
		Mkr->Freq	Sets the center frequency to the value at the current marker position. This item is available when Format is FreqAmpl. When you press this side key, the Freq, Span, Ref... → Freq setting changes to the frequency in the current marker position.

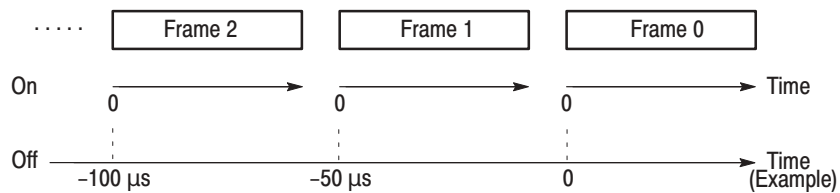

Figure 2-46: Frame Relative On and Off

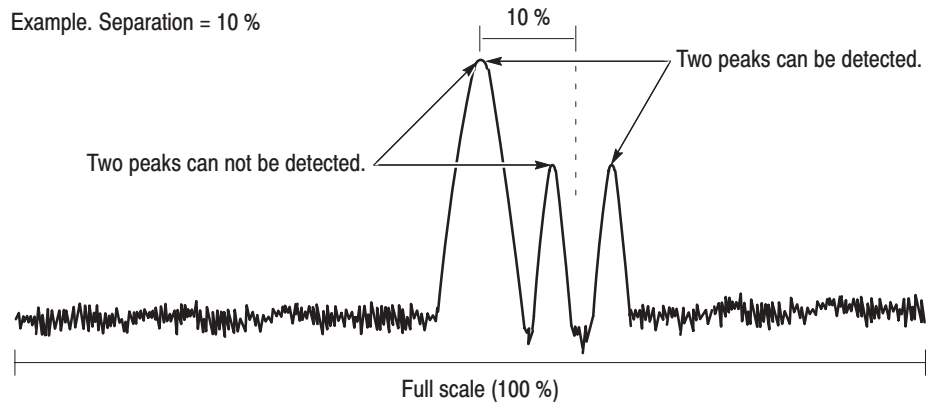

Figure 2-47: Separation setting

Analog View Menu

Table 2–8 summarizes the view menu when you have defined the view as Analog in the CONFIG:VIEW menu.

Refer to *Analyzing an Analog Modulated Signal* on page 3–95.

Table 2–8: Analog view menu table

Top level	Subordinate level, options and descriptions	
Source	Selects input data for a view. You can select one of the following items:	
	None	Specifies no input source. The display area in the view is empty.
	Active	Specifies the data memory storing acquired data for the input source.
	Zoom	Specifies the zoomed data for an input source. When you use the Zoom mode, select this. For zoom, refer to <i>Input and Memory Modes</i> on page 3–1 and <i>Zoom</i> on page 3–51.
	D1D2 to D7D8	Specifies a register pair for an input source. The digitally-modulated signal demodulated in the Polar view is written into the register pair. To display the spectrum of a demodulated digitally-modulated signal, use a register pair as the input signal. For demodulation of digitally-modulated signals, refer to <i>Display and Analysis of a Digitally-Modulated Signal</i> on page 3–97.
	File (*.IQ)	Specifies the IQ-formatted data file for the input source. On accessing files, refer to <i>File Access Menu</i> on page 2–119.
	File (*.AP)	Specifies the AP-formatted data file for the input source. On accessing files, refer to <i>File Access Menu</i> on page 2–119.
Format	Selects the signal modulation method. With the built-in demodulator, the analyzer can display the demodulated signal.	
	AM	Demodulates the amplitude-modulated signal. Horizontal axis: Time; Vertical axis: Modulating factor.
	PM	Demodulates the phase-modulated signal. Horizontal axis: Time; Vertical axis: Phase.
	FM	Demodulates the frequency-modulated signal. Horizontal axis: Time; Vertical axis: Frequency.
Frame	Specifies the number of the frame to be displayed. By default, it is set to frame 0 into which the current data is written.	

Table 2-8: Analog view menu table (cont.)

Top level	Subordinate level, options and descriptions			
Options...	Display Lines...	Controls the horizontal and vertical line markers. Same as Display Lines... in the Waveform view menu on page 2-65.		
	Copy To...	Copies the waveform currently being displayed to one of the destinations. Same as Copy To... in the Waveform view menu on page 2-66.		
	Hold Ver. Scale	Specifies whether you retain or reset the scale setting of the vertical axis when you change the input source. Same as Hold Ver. Scale in the Waveform view menu on page 2-66.		
	Scale, Marker, Search...	Scale...	Sets up the horizontal and vertical axes. Same as Scale... in the Waveform view menu on page 2-66.	
		Marker...	Operates the markers. Refer to page 3-45 for how to operate the markers.	
			Hor.	Inputs the horizontal position to move the □ marker. By default, the marker is positioned at the origin on the horizontal axis.
			Delta Marker	Turns the delta marker on or off.
			Toggle Delta	Changes the □ and ◇ marker positions each other.
		Search...	Searches for the peak spectrum and places the □ marker there.	
			Peak	Searches for the peak spectrum and moves the marker there. Rotate the general purpose knob clockwise to search the peak rightward, and vice versa.
			Max	Searches for the maximum peak spectrum and moves the marker there.
			Min	Searches for the minimum peak spectrum and moves the marker there.
			Separation	Sets the minimum horizontal distance to separate two peaks. Same as Separation in the Waveform view menu on page 2-68.
Delta Marker	Turns the delta marker on or off.			
Toggle Delta	Changes the □ and ◇ marker positions each other.			

FSK View Menu

Table 2–9 summarizes the view menu when you have defined the view as FSK in the CONFIG:VIEW menu.

Refer to *Analyzing an FSK Digitally-Modulated Signal* on page 3–109.

Table 2–9: FSK view menu table

Top level	Subordinate level, options and descriptions
Source	Selects input data for a view. Same as Source in the Analog view menu on page 2–69.
Frame	Specifies the number of the frame to be displayed. By default, it is set to frame 0 into which the current data is written.
Options...	Same as Options... in the Analog view menu on page 2–70.

Spectrogram View Menu

Table 2–10 summarizes the view menu when you have defined the view as Spectrogram in the CONFIG:VIEW menu.

Table 2–10: Spectrogram view menu table

Top level	Subordinate level, options and descriptions	
Source	Selects input data for a view. You can select one of the following items:	
	None	Specifies no input source. The display area in the view is empty.
	Active	Specifies the data memory storing acquired data for the input source.
	Zoom	Specifies the zoomed data for an input source. When you use the Zoom mode, select this. For zoom, refer to <i>Input and Memory Modes</i> on page 3–1 and <i>Zoom</i> on page 3–51.
	D1 to D8	Specifies one of the data registers of D1 to D8 for an input source. Copy data to this register using Options... → Copy To... in other view menus or Util C [Average] on a utility menu.
	File (*.IQ)	Specifies the IQ-formatted data file for the input source. On accessing files, refer to <i>File Access Menu</i> on page 2–119.
	File (*.AP)	Specifies the AP-formatted data file for the input source. On accessing files, refer to <i>File Access Menu</i> on page 2–119.
Format	Defines the horizontal and vertical axes.	
	FreqAmpl	Horizontal axis: Frequency (span) Vertical axis: Amplitude
	FreqPhase	Horizontal axis: Frequency (span) Vertical axis: Phase
Compression	Generally, as the horizontal number of pixels is smaller than the number of bins, bin data is thinned out in agree with the number of pixels on the screen when it is displayed. This item allows you to select a compression method. This item affects only data display, and appears only when you select a register of D1 to D8 for Source. For compressing display data, refer to <i>Relationship among Frames, Bins, and Pixels</i> on page 3–41.	
	Sample	Samples data at a regular interval to display it.
	Max	Displays the maximum value of the data for each pixel.
	Min	Displays the minimum value of the data for each pixel.
	Frame	Specifies the number of the frame to be displayed. By default, it is set to frame 0 into which the current data is written.
Ver. Start	Sets the start value of the vertical axis (i.e. frame number). By default, it is set to frame 0 into which the current data is written.	

Table 2-10: Spectrogram view menu table (cont.)

Top level	Subordinate level, options and descriptions			
Options...	Monochrome	Selects monochrome or color display.		
		On	Selects monochrome display.	
		Off	Selects color display (default).	
	Number Colors	Selects the number of display colors, 100 (default) or 10.		
	Hold Color Scale	Specifies whether you retain or reset the scale setting of the Y (color) axis when you change the input source.		
		On	Retains the scale setting of the Y axis.	
		Off	Resets the scale setting of the Y axis. The full-scale display results.	
	Time Scale	Specifies whether the time scale is displayed on screen.		
	Scale, Marker, Search...	Scale...	Sets up the horizontal and vertical axes.	
			Hor. Scale	Sets the horizontal axis scale.
			Hor. Start	Sets the horizontal axis start value.
			Ver. Scale	Sets the vertical axis scale. The range is 1 to 32. The frames are thinned out by this number. For example, if you set Ver. Scale to 10, the spectrogram is displayed every ten frames.
			Ver. Start	Same as Ver. Start on the top level on page 2-72.
			Color Scale	Inputs the height of the level represented in colors. The level is represented in ten colors from the minimum (blue) to the maximum (red). The level under the minimum is represented in black.
			Color Start	Inputs the start value of the level represented in colors.
			Full Scale	Sets the vertical axis to the default full-scale.
		Marker...	Operates the marker and the delta marker. The marker is represented as □. The delta marker is represented as □ and ◇. For how to use the markers, refer to page 3-45.	
			Hor.	Specifies the horizontal position to which you move □. By default, □ is positioned at the start point of the horizontal axis.
			Ver.	Specifies the vertical position, i.e. the frame number, to which you move □. By default, the marker is positioned in frame 0.
			Delta Marker	Turns the delta marker on or off.
Toggle Delta			Changes the □ and ◇ marker positions each other.	
Mkr→Freq			Sets the center frequency to the value at the current marker position. When you press this side key, the Freq, Span, Ref... → Freq setting in the SETUP menu changes to the frequency at the current marker position.	

Table 2-10: Spectrogram view menu table (cont.)

Top level	Subordinate level, options and descriptions	
		<p>Search... Searches for the peak spectrum and places the □ marker there. You can specify the frame by moving the marker vertically.</p> <p>Peak Searches the peak spectrum and moves the □ marker there. Rotate the general purpose knob clockwise to search the peak rightward, and vice versa.</p> <p>Max Searches for the maximum peak spectrum and moves the □ marker there.</p> <p>Min Searches for the minimum peak spectrum and moves the □ marker there. This item is available when Format is other than FreqAmpl.</p> <p>Separation Sets the minimum horizontal distance to separate two peaks. Same as Separation in the Waveform view menu on page 2-68.</p> <p>Ver. Specifies the vertical position, i.e. the frame number, to which you move □. By default, the marker is positioned in frame 0.</p> <p>Delta Marker Turns the delta marker on or off.</p> <p>Toggle Delta Changes the □ and ◇ marker positions each other.</p> <p>Mkr->Freq Sets the center frequency to the value at the current marker position. This item is available when Format is FreqAmpl. When you press this side key, the Freq, Span, Ref...→ Freq setting in the SETUP menu changes to the frequency at the current marker position.</p>
Ver. Mag	Sets the number of vertical pixels to display one frame. The range is 1 to 10.	

Waterfall View Menu

Table 2–11 summarizes the view menu when you have defined the view as Waterfall in the CONFIG:VIEW menu.

Table 2–11: Waterfall view menu table

Top level	Subordinate level, options and descriptions			
Source	Selects input data for a view. Same as Source in the Spectrogram view menu on page 2–72.			
Format	Defines the horizontal and vertical axes. Same as Source in the Waveform view menu on page 2–63.			
Compression	Selects a method of display data compression. Same as Compression in the Waveform view menu on page 2–63.			
Ver. Start	Sets the start value of the vertical axis (i.e. frame number). By default, it is set to frame 0 into which the current data is written.			
Options...	Hold Height Scale	Determines whether to retain or reset the Height Scale setting when changing Source.		
		On	Retains the Height Scale setting.	
		Off	Resets the Height Scale setting to full-scale.	
	Scale, Marker, Search...	Scale...	Sets up the horizontal and vertical axes.	
			Hor. Scale	Sets the horizontal axis scale.
			Hor. Start	Sets the horizontal axis start value.
			Ver. Scale	Sets the start value of the vertical axis (frame number). Input the number of frames to be displayed.
			Ver. Start	Same as Ver. Start described above on the top menu level.
			Height Scale	Sets the vertical axis scale in dB for Height described below on the top menu level.
			Height Start	Sets the start value in dBm for Height described below on the top menu level.
Full Scale			Sets the vertical axis to the default full-scale. This menu item is available when Format is FreqAmpl, FreqPhase, TimeAmpl, or TimePhase.	
Auto Scale	Automatically sets the start value and scale of the horizontal and vertical axes so that the entire waveform can be displayed. This menu item is available when Format is FreqI, FreqQ, TimeI, or TimeQ.			
	Marker...	Operates the marker and the delta marker. Same as Marker... in the Spectrogram view on page 2–73.		
	Search...	Searches for the peak spectrum and places the <input type="checkbox"/> marker there. Same as Search... in the Spectrogram view on page 2–74.		
Height	Sets the vertical (amplitude) full-scale of one frame in pixel for displaying. The range is 1 to 100 pixels.			
Gap	Specifies the interval between adjacent waveforms on screen. The range is 1 to 100 pixels.			

Polar View Menu

Table 2–12 summarizes the view menu when you have defined the view as Polar in the CONFIG:VIEW menu.

Refer to *Display and Analysis of a Digitally-Modulated Signal* on page 3–97.

Table 2–12: Polar view menu table

Top level	Subordinate level, options and descriptions		
Source	Specifies the source data for the view.		
	None	Specifies no input source. The display area in the view is empty.	
	Active	Specifies the data memory storing acquired data for the input source.	
	Zoom	Specifies the zoomed data for an input source. When you use the Zoom mode, select this. For zoom, refer to <i>Input and Memory Modes</i> on page 3–1 and <i>Zoom</i> on page 3–51.	
	File(*.IQ)	Specifies the IQ-formatted data file for the input source. On accessing files, refer to <i>File Access Menu</i> on page 2–119.	
Frame	Specifies the number of the frame to be displayed. By default, it is set to frame 0 into which the current data is written.		
Standard...	Configures the analyzer according to the standard digital modulating system settings.		
	NADC	Configures the analyzer according to NADC (North American Digital Cellular).	
	PDC	Configures the analyzer according to PDC (Personal Digital Cellular System).	
	PHS	Configures the analyzer according to PHS (Personal Handy Phone System).	
	TETRA	Configures the analyzer according to TETRA (Trans-European Trunked Radio).	
	GSM	Configures the analyzer according to GSM (Global System for Mobile Communication).	
	CDPD	Configures the analyzer according to CDPD (Cellular Digital Packet Data).	
Manual Setup...	Sets the modulating system, symbol rate, filter, and α /BT manually.		
	Modulation	Selects the modulating system required to demodulate the digitally-modulated signal.	
		1/4 PI_QPSK	Specifies 1/4 π Shift QPSK (Quadrature Phase Shift Keying) modulation.
		BPSK	Specifies BPSK (Binary Phase Shift Keying) modulation.
		QPSK	Specifies QPSK (Quadrature Phase Shift Keying) modulation.
		8PSK	Specifies 8PSK (Phase Shift Keying) modulation.
		16QAM	Specifies 16QAM (Quadrature Amplitude Modulation) modulation.
		64QAM	Specifies 64QAM (Quadrature Amplitude Modulation) modulation.
		256QAM	Specifies 256QAM (Quadrature Amplitude Modulation) modulation.
		GMSK	Specifies GMSK (Gaussian-filtered Minimum Shift Keying) modulation.
GFSK	Specifies GFSK (Gaussian-filtered Frequency Shift Keying) modulation.		

Table 2-12: Polar view menu table (cont.)

Top level	Subordinate level, options and descriptions		
	Symbol Rate	Inputs the symbol rate required to demodulate the digitally-modulated signal. There is the following relationship between the symbol and bit rates: $(\text{Symbol rate}) = [(\text{Bit rate}) \times (1 \text{ state})] / (\text{Number of bits})$	
	Measurement Filter	Selects None (no filter) or RootRaisedCosine for the filter required to demodulate the digitally-modulated signal. Refer to <i>Processing Flow</i> on page 3-98 for detail.	
	Reference Filter	Selects None (no filter), RaisedCosine, or Gaussian for the filter required to create reference data. Refer to <i>Processing Flow</i> on page 3-98 for detail.	
	Alpha/BT	Inputs the α /BT value. The range is 0.0001 to 1.	
	Auto Carrier	Determines whether to search the carrier automatically.	
		On	Searches the carrier automatically, and displays the frequency error relative to the center frequency on screen at Freq Err.
	Off	Sets the carrier frequency to the value with the Carrier (Hz) side key which appears by pressing the Off button.	
	Carrier	Sets carrier frequency when you select Off in Auto Carrier above.	
Burst...	Sets the burst search parameters.		
	Number Frames	Specifies the number of frames to be analyzed. When the burst exceeds one frame, set this parameter to 2, 4, or 8.	
	Search	Specifies whether to search burst (On) or not (Off). <i>NOTE. When you search bursts, set the frame position to 0 % with the Options...→ Position menu item. If you use the default position (100 %), you cannot find the bursts.</i>	
	Block Size	Specifies the frame range to search a burst from the frame specified with Frame (refer to page 2-76). The range is 1 to 20 frames.	
	Peak Threshold	Sets the threshold to validate the burst. If the peak level of an input signal exceeds the threshold, it is recognized as a burst. If not, it is discarded as noise. The range is -100 dB to 10 dB relative to the maximum data value.	
	Threshold	Sets the threshold to detect the rising edge of a burst. The range is -100 dB to 10 dB relative to the maximum data value.	
	Offset	Specifies the first data point to be analyzed relative to the beginning of burst within the range of -1024 to +1024. For example, when you set it to -100, the measurement is made from the hundredth data point before the beginning of burst.	
Mask...	Specifies the frequency range to be processed. The data out of the range is ignored for calculating.		
	Mask	Enables (On) or disables (Off) the masking.	
	Marker Link	Specifies whether the Center value described below varies with the marker movement on the frequency axis in the other view.	
	Center [Hz]	Sets the center frequency of the mask range with Width described below.	
	Width [Hz]	Sets the width of the mask range with Center described above.	
	Left [Hz]	Sets the left edge frequency of the mask range with Right described below.	
	Right [Hz]	Sets the right edge frequency of the mask range with Left described above.	

Table 2-12: Polar view menu table (cont.)

Top level	Subordinate level, options and descriptions	
Options...	Display	The polar view can display either measurement data or a reference signal, which has been demodulated and modulated in this view. Refer to <i>Processing Flow</i> on page 3-98 for detail.
		Measurement Selects the measurement data for display.
		Reference Selects the reference data for display.
	Format	Selects the display format.
		Vector Displays a data in vector format that represents symbol-to-symbol movements using a vector.
		Constellation Displays data in constellation format that represents only symbols.
	Marker	Inputs the time to move the <input type="checkbox"/> marker.
	Measurement Destination	Selects the register pair used to write the data resulting after the signal passes through the Measurement filter. See Reference Destination just below for the selections.
	Reference Destination	Selects the register pair used to write the data resulting after the signal passes through the Measurement filter, demodulating mechanism, and Reference filter. Refer to <i>Processing Flow</i> on page 3-98 for detail.
		None Specifies no output source.
		D1D2-D7D8 Specify a register pair for the output source. Use default settings when possible. A pair of data registers (D1 to D8) is called a register pair. The possible combinations are D1D2, D3D4, D5D6, and D7D8. They are mainly used to write the I and Q component data of a digitally modulated signal. <i>NOTE. For register pairs, two of the D1 to D8 data registers are combined for use. For example, if the D1D2 register pair is used for observation of the digitally-modulated signal and the Average function is using the D1 register, the resulting display will be unpredictable. If these two functions are in use concurrently, do not use the same register for the two functions.</i>
Position	Specifies the number of the frame to be displayed after a trigger event. If this frame number agrees with the trigger position specified with Setup → Trigger... → Pos, the frame for which a trigger is generated is displayed. By default, Position is set to zero (current frame).	

EyeDiagram View Menu

Table 2–13 summarizes the view menu when you have defined the view as EyeDiagram in the CONFIG:VIEW menu.

Refer to *Display and Analysis of a Digitally-Modulated Signal* on page 3–97.

Table 2–13: EyeDiagram view menu table

Top level	Subordinate level, options and descriptions	
Source	Specifies the source data for the view. Refer to <i>Process Flow</i> on page 3–98.	
	Measurement	Specifies the Measurement data (register pair) output from the Polar View as the input source.
	Reference	Specifies the Reference data (register pair) output from the Polar View as the input source.
Format	Selects the display format.	
	I	Displays Eye diagram with I data along the vertical axis.
	Q	Displays Eye diagram with Q data along the vertical axis.
	Trellis	Displays Eye diagram with phase along the vertical axis.
Eye Length	Sets the length of the symbol to be displayed. This is the scale setting for the horizontal axis. The time length required for symbol-to-symbol movement is defined as 1. The range is 1 to 16.	
Marker	Inputs the time to move the <input type="checkbox"/> marker.	

SymbolTable View Menu

Table 2–14 summarizes the view menu when you have defined the view as SymbolTable in the CONFIG:VIEW menu.

Refer to *Display and Analysis of a Digitally-Modulated Signal* on page 3–97.

Table 2–14: SymbolTable view menu table

Top level	Subordinate level, options and descriptions	
Source	Specifies the source data for the view. Same as Source in the EyeDiagram view menu on page 2–79.	
Radix	Selects Hex (hexadecimal), Oct (octal), or Bin (binary) for the notation of numeric values displayed.	
Rotate	Selects the numeric value start position from 0 to 3. This setting is unavailable for the $1/4 \pi$ QPSK and GMSK modulating systems.	
Symbol	Inputs the symbol position to place the <input type="checkbox"/> marker. The range is 0 to the number of symbols – 1.	
Copy To...	Copies the symbol data currently being displayed to one of the following destinations.	
	Clipboard	Converts the symbol data currently being displayed into the text form to copy it to the Windows clipboard. The text data on the clipboard can be passed to PC applications. For details, refer to page 3–206.
	Text File	Converts the symbol data currently being displayed into the text form to copy it to a text file. For details, refer to page 3–206.
	D1 to D8	Selects a data register in which the symbol data currently being displayed is saved temporarily.

EVM View Menu

Table 2–15 summarizes the view menu when you have defined the view as EVM in the CONFIG:VIEW menu.

Refer to *Display and Analysis of a Digitally-Modulated Signal* on page 3–97.

Table 2–15: EVM view menu table

Top level	Subordinate level, options and descriptions				
Format	Selects the display format. For the detail, refer to <i>Error Vector Analysis Display</i> on page 3–106.				
	EVM	Displays the error vector magnitude. The vertical axis represents the percentage of error vector magnitude, and the horizontal axis represents the time.			
	Mag Error	Displays the amplitude error. The vertical axis represents the percentage of amplitude error, and the horizontal axis represents the time.			
	Phase Error	Displays the phase error. The vertical axis represents the percentage of phase error, and the horizontal axis represents the time.			
Mask Type	Selects the way to specify the mask area that is excluded from calculating EVM.				
	Percent	Specifies the mask area with percent in the Mask Percent menu item described below.			
	Symbol	Specifies the mask area with the symbol number in the Mask Left and Right menu item described below.			
Mask Percent	Specifies the mask area with percent on screen. The range is 0 to 50 % relative to full-scale. 0 % excludes no area and 50 % does whole area from the EVM calculation. For example, 10 % specifies that 10 % area of both left and right ends are excluded. See Figure 2–48 on page 2–82.				
Mask Left	Sets the symbol number for the left mask area. The left area from the specified symbol number is excluded from the EVM calculation.				
Mask Right	Sets the symbol number for the right mask area. The right area from the specified symbol number is excluded from the EVM calculation.				
Options...	Display Lines...	Controls the horizontal and vertical line markers. Same as Display Lines... in the Waveform view menu on page 2–65.			
	Copy To...	Copies the waveform currently being displayed to one of the destinations. Same as Copy To... in the Waveform view menu on page 2–66.			
	Scale, Marker, Search...	Scale...	Sets up the horizontal and vertical axes. Same as Scale... in the Waveform view menu on page 2–66.		
		Marker...	Operates the marker and the delta marker. The marker is represented as □. The delta marker is represented as ◻ and ◊. For how to use the markers, refer to page 3–45.		
			Symbol	Inputs the symbol position to place the □ marker. The range is 0 to the number of symbols –1.	
			Delta Marker	Turns the delta marker on or off.	
Toggle Delta			Changes the ◻ and ◊ marker positions each other.		

Table 2-15: EVM view menu table (Cont.)

Top level	Subordinate level, options and descriptions		
	Search...	Searches for the peak spectrum and places the □ marker there.	
		Max	Searches the maximum peak spectrum and moves the marker there.
		Min	Searches the minimum peak spectrum and moves the marker there.

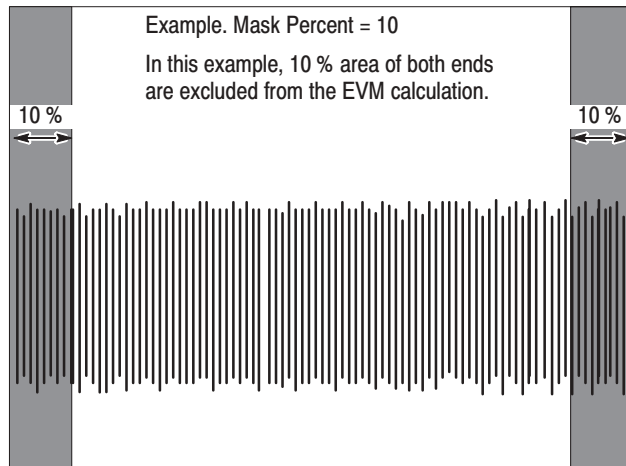

Figure 2-48: Setting Mask Percent for the EVM calculation

CDMAWaveform View Menu

Table 2–15 summarizes the view menu when you have defined the view as CDMAWaveform in the CONFIG:VIEW menu.

NOTE. The CDMAWaveform view is used to perform the measurement in accordance with the IS-95 and T-53 standards.

Table 2–16: CDMAWaveform view menu table

Top level	Subordinate level, options and descriptions	
Source	Selects input data for a view. You can select one of the following items:	
	None	Specifies no input source. The display area in the view is empty.
	Active	Specifies the data memory storing acquired data for the input source.
	Average	Specifies the averaged data for the input source. When you select this item, Format and Frame menu disappears, and Average Type and Num Averages menu appears.
	Zoom	Specifies the zoomed data for an input source. When you use the Zoom mode, select this. For zoom, refer to <i>Input and Memory Modes</i> on page 3–1 and <i>Zoom</i> on page 3–51.
	D1D2 to D7D8	Specifies a register pair for an input source. The digitally-modulated signal demodulated in the Polar view is written into the register pair. To display the spectrum of a demodulated digitally-modulated signal, use a register pair as the input signal. For demodulation of digitally-modulated signals, refer to <i>Display and Analysis of a Digitally-Modulated Signal</i> on page 3–97.
	D1 to D8	Specifies one of the data registers of D1 to D8 for an input source. You should have copied the data to this register using Options...→ Copy To... in other view menus or Util C [Average] on the utility menu.
	File (*.IQ)	Specifies the IQ-formatted data file for the input source. On accessing files, refer to <i>File Access Menu</i> on page 2–119.
File (*.AP)	Specifies the AP-formatted data file for the input source. On accessing files, refer to <i>File Access Menu</i> on page 2–119.	
Format	Defines the horizontal and vertical axes. Same as Format in the Waveform view menu on page 2–64.	
Compression	Selects the display data compression method. Same as Format in the Waveform view menu on page 2–64.	
Frame	Specifies the number of the frame to be displayed. By default, it is set to frame 0 into which the current data is written. If you select Average for the above Source, frame selection is meaningless; this item disappears from the menu.	
Average Type	Selects an average type. Same as Average Type in the Waveform view menu on page 2–64. For details on averaging, refer to <i>Average and Peak Hold</i> on page 3–57.	
Num Averages	Specifies the number of frames to be averaged. Same as Num Averages in the Waveform view menu on page 2–64.	
Options...	Mask...	Sets up a mask to make PASS/FAIL decision for the displayed waveform. The default values meet the IS-95 standard. For detail, refer to <i>Specified Line Settings</i> on page 3–119.
	Display Lines...	Controls the horizontal and vertical line markers. Same as Display Lines... in the Waveform view menu on page 2–65.

Table 2-16: CDMAWaveform view menu table (cont.)

Top level	Subordinate level, options and descriptions			
	Copy To...	Copies the waveform currently being displayed to one of the destinations. Same as Copy To... in the Waveform view menu on page 2-66.		
	Copy From...	Loads text data from the file to which the waveform was copied using Copy To... This menu item appears only when you select a register of D1 to D8 for Source.		
	Position	Specifies the number of the frame to be displayed after a trigger event. If this frame number agrees with the trigger position specified with Setup → Trigger... → Pos, the frame for which a trigger is generated is displayed. By default, Position is set to zero (the current frame).		
	Hold Ver. Scale	Specifies whether you retain or reset the scale setting of the vertical axis when you change the input source. Same as Hold Ver. Scale in the Waveform view menu on page 2-66.		
	Scale, Marker, Search...	Scale...	Sets up the horizontal and vertical axes. Same as Scale... in the Waveform view menu on page 2-66.	
		Marker...	Operates the marker and the delta marker. The marker is represented as the symbol □. The delta marker is represented as □ and ◇. For how to use the markers, refer to page 3-45.	
			Hor.	Specifies the horizontal position to which you move the marker □. By default, □ is positioned at the origin of the horizontal axis.
			Spurious	Places the marker on one of the spurious signals that have been detected. This view detects eight spurious signals. When you press the Spurious side key, the Up and Down keys appear on the menu item. Each time you press the Up arrow key, the marker moves from a spurious position to the next stronger one. Each time you press the Down arrow key, the marker moves from a spurious position to the next weaker one. This function is useful to examine the spurious position and intensity when you have set to something other than Spurious in the Measurement menu item.
			Delta Marker	Turns the delta marker on or off.
			Toggle Delta	Changes the □ and ◇ marker positions each other.
			Search...	Searches for the peak spectrum and places the □ marker there.
		Peak		Searches the peak spectrum and moves the □ marker there. Rotate the general purpose knob clockwise to search the peak rightward, and vice versa.
		Max		Searches for the maximum peak spectrum and moves the marker there.
		Min		Searches for the minimum peak spectrum and moves the marker there. This item is available when Format is other than FreqAmpl.

Table 2-16: CDMAWaveform view menu table (cont.)

Top level	Subordinate level, options and descriptions		
			Separation Sets the minimum horizontal distance to separate two peaks. Same as Separation in the Waveform view menu on page 2-68.
			Delta Marker Turns the delta marker on or off.
			Toggle Delta Changes the □ and ◇ marker positions each other.
RBW	Selects the resolution bandwidth (RBW). The default is 30 kHz. When you select Off, the input signal is displayed as is.		
Measurement	The measured value is displayed at the top left corner of the view. Select one of the following for its mode:		
	Off	Displays no measurement value.	
	Power	Displays Power (in-band power) and OBW (occupied bandwidth). For OBW, the default power ratio between the carrier frequency domain and the whole span area is set to 99% by default, which is the value specified in the IS-95 or T-53 standard. It can be changed with Measurement Option... → OBW. Refer to page 3-88 for the OBW measurement concept. Refer to page 3-84 for the Power measurement concept.	
	Spurious	In addition to Power and OBW above, the eight detected spurious signal power and frequency positions are displayed.	
Measurement Options...	You can change the following measurement parameters:		
	OBW	Specifies the power ratio between the current frequency area and the whole span area that is used to calculate the occupied bandwidth (OBW). The range is 90 to 99.8 %. By default, 99 % is set as specified in IS-95 and T-53.	
	Separation	Specifies the ratio (%) of the frequency resolution to the span frequency. This resolution is used to distinguish two adjacent peak spectrums as being independent spurious signals for the spurious search.	
	Threshold	Sets the threshold level relative to the reference level to detect spurious signals.	
	Sorted by	Specifies the order of the number tags assigned to the eight detected spurious signal. If you select Level, the tags will be numbered in level order. If you select Frequency, they will be numbered in frequency order.	
	Spurious Search	Usually, keep it On throughout the spurious measurement. If you select Off with the number tag displayed, the tag display position will not change during all subsequent measurements. This setting is useful to observe time-dependent changes of the detected spurious signals.	
	Standard	Selects either IS-95 or T-53 standard.	
	Channel	Specifies the measurement channel. Displays the specified mask line of the specified channel. By default, the channel matches the one you specify in SETUP (CDMA) → Freq, Span, Ref...	

CDMAPolar View Menu

Table 2–17 summarizes the view menu when you have defined the view as CDMAPolar in the CONFIG:VIEW menu.

Refer to *Display and Analysis of a Digitally-Modulated Signal* on page 3–97.

NOTE. The CDMAPolar view is based on the Polar view, adding the measurement functions according to the IS-95 and T-53 standards. Usually, use the Polar view. When you perform measurements according to the IS-95 or T-53 standards, use the CDMAPolar view.

Table 2–17: CDMAPolar view menu table

Top level	Subordinate level, options and descriptions		
Source	Specifies the source data for the view. Same as Source in the Polar view menu on page 2–76.		
Frame	Specifies the number of the frame to be displayed. By default, it is set to frame 0 into which the current data is written.		
Standard...	Configures the analyzer according to the standard digital modulating system settings.		
	NADC	Configures the analyzer according to NADC (North American Digital Cellular).	
	PDC	Configures the analyzer according to PDC (Personal Digital Cellular System).	
	PHS	Configures the analyzer according to PHS (Personal Handy Phone System).	
	TETRA	Configures the analyzer according to TETRA (Trans-European Trunked Radio).	
	GSM	Configures the analyzer according to GSM (Global System for Mobile Communication).	
	CDPD	Configures the analyzer according to CDPD (Cellular Digital Packet Data).	
	IS-95	Configures the analyzer according to IS-95.	
Manual Setup...	Sets the modulating system, symbol rate, filter, and α /BT manually.		
	Modulation	Selects the modulating system required to demodulate the digitally-modulated signal.	
		1/4 PI_QPSK	Specifies 1/4 π Shift QPSK (Quadrature Phase Shift Keying) modulation.
		BPSK	Specifies BPSK (Binary Phase Shift Keying) modulation.
		QPSK	Specifies QPSK (Quadrature Phase Shift Keying) modulation.
		8PSK	Specifies 8PSK (Phase Shift Keying) modulation.
		16QAM	Specifies 16QAM (Quadrature Amplitude Modulation) modulation.
		64QAM	Specifies 64QAM (Quadrature Amplitude Modulation) modulation.
		256QAM	Specifies 256QAM (Quadrature Amplitude Modulation) modulation.
		GMSK	Specifies GMSK (Gaussian-filtered Minimum Shift Keying) modulation.
		GFSK	Specifies GFSK (Gaussian-filtered Frequency Shift Keying) modulation.
CDMA_OQPSK	Specifies CDMA OQPSK (Offset QPSK) used in the IS-95 standard.		

Table 2-17: CDMAPolar view menu table (cont.)

Top level	Subordinate level, options and descriptions	
	Symbol Rate	Inputs the symbol rate required to demodulate the digitally-modulated signal. There is the following relationship between the symbol and bit rates: $(\text{Symbol rate}) = [(\text{Bit rate}) \times (1 \text{ state})] / (\text{Number of bits})$
	Measurement Filter	Selects None (no filter), RootRaisedCosine, or IS95 for the filter required to demodulate the digitally-modulated signal. Refer to <i>Processing Flow</i> on page 3-98 for detail.
	Reference Filter	Selects None (no filter), RaisedCosine, Gaussian, or IS95 for the filter required to create reference data. Refer to <i>Processing Flow</i> on page 3-98 for detail.
	Alpha/BT	Inputs the α /BT value. The range is 0.0001 to 1.
	Auto Carrier	Determines whether to search the carrier automatically.
		On Searches the carrier automatically, and displays the frequency error relative to the center frequency on screen at Freq Err.
		Off Sets the carrier frequency with the Carrier (Hz) side key which appears by selecting Off.
	Carrier	Sets carrier frequency when you select Off in Auto Carrier above.
Burst...	Sets the burst search parameters. Same as Burst... in the Polar view menu on page 2-77.	
Mask...	Specifies the frequency range to be processed. Same as Mask... in the Polar view menu on page 2-77.	
Options...	Same as Options.. in the Polar view menu on page 2-78.	

CDMATime View Menu

Table 2–17 summarizes the view menu when you have defined the view as CDMATime in the CONFIG:VIEW menu.

NOTE. Use the CDMATime view to perform the measurement according to the IS-95 and T-53 standards.

NOTE. For the CDMA time characteristic measurement, use the **Measure** side key rather than the front panel **ROLL** or **BLOCK** key.

If you use the **ROLL** or **BLOCK** key for the measurement, neither averaging nor mask decision takes place although the measurement can be performed. In this case, the horizontal axis in the CDMATime view represents the time in the Block mode or the frequency in the Roll mode.

Table 2–18: CDMATime view menu table

Top level	Subordinate level, options and descriptions	
Source	Specifies the source data for the view. Same as Source in Polar view menu on page 2–76.	
Block	Specifies the block position to be displayed. By default, the data of Block 0 is displayed. In the Block mode, data is acquired in the number of frames specified as on block with SETUP (CDMA) → Block Size. If the data has been acquired in two or more blocks, you can specify this block position to display the data. The block containing the latest acquired data is defined as Block 0. Refer to <i>Acquiring Data</i> on page 3–21.	
Trace1 (Raw)	If set to On, the acquisition data is displayed by a green trace. If set to Off, this display disappears.	
Trace2 (Average)	If set to On, the averaged waveform is displayed in yellow. If set to Off, this display disappears. This menu item appears when the you use the Measure or Measure Data side menu for the measurement.	
Options...	Mask...	Sets up a mask to make PASS/FAIL decision for the displayed waveform. The default values meet the IS-95 standard. For detail, refer to <i>Mask Settings</i> on page 3–123.
	Num Averages	Specifies the averaging count. The default is 100 (specified in the IS-95 standard). Be sure to use the Measure side menu for the measurement.
	Display Lines...	Controls the horizontal and vertical line markers. Same as Display Lines... in the Waveform view menu on page 2–65.
	Position	Specifies the frame to be displayed in the block set with Block. The range is 0 to 100 %. 0 % represents the first frame in the block, and 100 % represents the last.
	Hold Ver. Scale	Specifies whether you retain or reset the scale setting of the vertical axis when you change the input source. Same as Hold Ver. Scale in the Waveform view menu on page 2–66.

Table 2-18: CDMATime view menu table (cont.)

Top level	Subordinate level, options and descriptions		
Scale, Marker, Search...	Scale...	Scales the horizontal and vertical axes.	
		Hor. Scale	Sets the horizontal axis scale.
		Hor. Start	Sets the horizontal axis start value.
		Ver. Scale	Sets the vertical axis scale.
		Ver. Start	Sets the vertical axis start value.
		Rising Edge	Enlarges the waveform around the rising edge.
		Falling Edge	Enlarges the waveform around the falling edge.
	Full Scale	Returns the usual display state when the rising or falling edge waveform is in enlarged display.	
	Marker...	Operates the marker and the delta marker. The marker is represented as the symbol □, and the delta marker as ◊. For how to use the markers, refer to page 3-45.	
		Hor.	Specifies the horizontal position to which you move □. By default, □ is positioned at the origin of the horizontal axis.
		Delta Marker	Turns the delta marker on or off.
		Toggle Delta	Changes the □ and ◊ marker positions each other.
	Search...	Searches for the peak spectrum and places the □ marker there. Same as Search... in the CDMAWaveform view menu on page 2-84.	
Measure	<p>Pressing this side key measures the CDMA time characteristic for the input signal. The analyzer acquires data 100 times by default, and displays the averaged waveform as Trace2 in yellow. The PASS/FAIL decision is made by comparing the averaged waveform with the mask settings.</p> <p>You can specify the averaging count with Option...→ Num Averages. The IS-95 standard requires that the values from 100 measurements be averaged.</p> <p>To abort the measurement after you press Measure side key, press the Break side key.</p>		
Measure Data	<p>Measures the CDMA time characteristic for the data already contained in memory. It is useful, for example, when you loaded the data from a file.</p> <p>To abort the measurement after you press Measure side key, press the Break side key.</p>		

CodeSpectrogram View Menu

Table 2–19 summarizes the view menu when you have defined the view as CodeSpectrogram in the CONFIG:VIEW menu.

According to the cdmaOne standard, this view displays each channel power measured for each symbol in color with channel along the horizontal axis and symbol (time) along the vertical axis.

For details on cdmaOne analysis, refer to page 3–127.

Table 2-19: CodeSpectrogram view menu table

Top level	Subordinate level, options and descriptions			
Symbol	Specifies the symbol number on which the marker is positioned.			
Ver. Start	Specifies the start symbol number on the vertical axis. The default is the symbol 0 which contains the current data.			
Options...	Y Axis	Selects relative or absolute representation for the Y (color) axis.		
		Relative Represents relative channel power to the total power along the Y axis.		
		Absolute Represents absolute channel power along the Y axis.		
	Monochrome	Selects the monochrome (On) or color (Off) display. The default is the color display.		
	Number Colors	Selects the number of display colors, either 100 (default) or 10.		
	Scale, Marker, Search...	Scale...	Sets up the horizontal and vertical axes. Same as Scale... in the Spectrogram view menu on page 2-73.	
		Marker...	Operates the marker and the delta marker. The marker is represented as the symbol □. The delta marker is represented as ◊ and ◇. For how to use the markers, refer to page 3-45.	
			Hor.	Specifies the horizontal position to which you move □. By default, □ is positioned at the start point of the horizontal axis.
			Ver.	Specifies the vertical position, i.e. the symbol number to which you move □. By default, the marker is positioned at symbol 0.
			Delta Marker	Turns the delta marker on or off.
			Toggle Delta	Changes the □ and ◇ marker positions each other.
		Search...	Searches for the peak spectrum and places the □ marker there. You can specify the symbol by moving the marker vertically.	
			Peak	Searches the peak spectrum and moves the □ marker there. Rotate the general purpose knob clockwise to search the peak rightward, and vice versa.
			Max	Searches for the maximum peak spectrum and moves the □ marker there.
			Min	Searches for the minimum peak spectrum and moves the □ marker there.
			Separation	Sets the minimum horizontal distance to separate two peaks. Same as Separation in the Waveform view menu on page 2-68.
			Ver.	Specifies the vertical position, i.e. the symbol number to which you move □. By default, the marker is positioned in frame 0.
Toggle Delta			Changes the □ and ◇ marker positions each other.	
Ver. Mag		Sets the number of vertical pixels to display one frame. The range is 1 to 10.		

CodePolar View Menu

Table 2–20 summarizes the view menu when you have defined the view as CodePolar in the CONFIG:VIEW menu.

This view displays IQ loci and chip positions according to the cdmaOne standard. For details on cdmaOne analysis, refer to page 3–127.

Table 2–20: CodePolar view menu table

Top level	Subordinate level, options and descriptions		
Source	Specifies the source data for the view. Same as Source in the Polar view menu on page 2–76.		
Analysis Symbol	Specifies the symbol number to display the IQ locus. The default is symbol 0 which contains the latest data.		
Standard...	Configures the analyzer according to the standard digitally-modulating system settings.		
	IS-95	Configures the modulating system according to IS-95 without equalizer.	
	IS-95+EQ	Configures the modulating system according to IS-95 with equalizer.	
Manual Setup...	Sets the modulating system, symbol rate, filter, and α /BT manually.		
	Modulation	Selects the modulating system required to demodulate the digitally-modulated signal.	
		IS-95	Selects IS-95 without equalizer.
		IS-95+EQ	Selects IS-95 with equalizer.
	Chip Rate	Inputs the chip rate to demodulate the digitally-modulated signal. The value must be 1.2288M.	
	Measurement Filter	Selects the filter required to demodulate the digitally-modulated signal. You can select either None (no filter) or RootRaisedCosine. Refer to <i>Processing Flow</i> on page 3–98 for detail.	
	Reference Filter	Selects None (no filter), RaisedCosine, Gaussian, or IS95 for the filter required for creating reference data. Refer to <i>Processing Flow</i> on page 3–98 for detail.	
	Alpha/BT	Inputs the α /BT value.	
Auto Carrier	Determines whether to search the carrier automatically. Same as Auto Carrier in the Polar view menu on page 2–77.		
Options...	Display	The polar view can display either measurement data or a reference signal, which has been demodulated and modulated in this view. Refer to <i>Processing Flow</i> on page 3–98 for detail.	
		Measure	Selects the measurement data for display.
		Reference	Selects the reference data for display.
	Format	Selects the display format.	
		Vector	Displays a data in vector format that represents chip-to-chip movements using a vector.
Constellation		Displays data in constellation format that represents only chips.	
Marker	Inputs the time to move the <input type="checkbox"/> marker.		
Analyze	Performs measurement for all the symbols on data memory.		

CodePower View Menu

Table 2–21 summarizes the view menu when you have defined the view as CodePower in the CONFIG:VIEW menu.

According to the cdmaOne standard, this view displays each channel power measured for the symbol, by default, specified with Symbol in CodeSpectrogram view menu. For details on cdmaOne analysis, refer to page 3–127.

Table 2–21: CodePower view menu table

Top level	Subordinate level, options and descriptions		
X Axis	Defines the parameter for the horizontal axis.		
	Code	Specifies that the horizontal axis represents code numbers.	
	Symbol	Specifies that the horizontal axis represents symbol numbers. The display is for the channel on which the marker is positioned when the horizontal axis is code numbers.	
Average	Determines whether to perform averaging or not.		
	Off	Specifies no averaging.	
	On	Displays the measurement results averaged for the number of symbols specified with Num Averages below.	
Average Type	Selects the average mode.		
	RMSExpo	Performs averaging with the exponential RMS (root-mean-square). This mode decreases the influence of the older data exponentially.	
	RMS	Performs averaging with RMS (root-mean-square).	
	MaxHold	Holds the maximum value.	
	MinHold	Holds the minimum value.	
Num Averages	Specifies the number of symbols to be averaged. The range is 1 to 10 ⁶ . If Average Type is set to RMS, frames specified with Num Averages are averaged before switching to a fixed display. If Average Type is set to RMSExpo, Num Averages is used for weighing old data. Refer to page 3–57 for details on averaging.		
Symbol	Specifies the number of the symbol to be displayed. The default is symbol 0 which contains the latest data. This menu item is displayed only when Average is Off.		
Options...	Y Axis	Selects relative or absolute representation for the vertical axis.	
		Relative	Represents relative channel power to the total power along the vertical axis.
		Absolute	Represents absolute channel power along the vertical axis.
	Display Lines...	Controls the horizontal and vertical line markers. Same as Display Lines... in the Waveform view menu on page 2–65.	

Table 2-21: CodePower view menu table (cont.)

Top level	Subordinate level, options and descriptions	
Scale, Marker, Search...	Scale...	Sets up the horizontal and vertical axes.
		Hor. Scale Sets the horizontal axis scale.
		Hor. Start Sets the horizontal axis start value.
		Ver. Scale Sets the vertical axis scale.
		Ver. Start Sets the vertical axis start value.
		Auto Scale Automatically sets the start value and scale of the vertical axis so that the entire waveform can be displayed.
	Marker...	Operates the markers. Same as Marker... in the Analog view menu on page 2-70.
	Search...	Searches for the peak spectrum and places the <input type="checkbox"/> marker there. Same as Search... in the Analog view menu on page 2-70.
Average Options...	Sets the averaging parameters and starts the process.	
	Begin Symbol	Specifies the first symbol to be averaged. The range is 0 to the number of symbols - 1.
	End Symbol	Specifies the last symbol to be averaged. The range is 0 to the number of symbols - 1.
	All Symbols	Specifies that the data is averaged for all the symbols.
	Mkr -> Symbol	Sets Begin Symbol and End Symbol with the marker and delta marker.
	Average Type	Same as Average Type above on the top menu level.
	Execute	Executes averaging.

CodeWSpectrogram View Menu

Table 2–22 on the next page summarizes the view menu when you have defined the view as CodeWSpectrogram in the CONFIG:VIEW menu.

According to the W-CDMA standard, this view displays each channel power measured for each slot in color with channel along the horizontal axis and slot (time) along the vertical axis.

For details on W-CDMA analysis, refer to page 3–135.

Table 2-22: CodeWSpectrogram view menu table

Top level	Subordinate level, options and descriptions			
Time Slot	Specifies the time slot number on which the marker is positioned.			
Ver. Start	Specifies the start time-slot number on the vertical axis. The default is slot 0 which contains the latest data.			
Symbol Rate	Composite/16/ 32/64/128/256/ 512/1024 ksps	It is set to Composite by default that corresponds to multi-rate. When you select the other specific value, the measurement is done with the fixed rate.		
Options...	Y Axis	Selects relative or absolute representation for the Y (color) axis.		
		Relative	Represents relative channel power to the total power along the Y axis.	
		Absolute	Represents absolute channel power along the Y axis.	
	Monochrome	Selects the monochrome (On) or color (Off) display. The default is the color display.		
	Number Colors	Selects the number of display colors, 100 (default) or 10.		
	Scale, Marker, Search...	Scale...	Sets up the horizontal and vertical axes. Same as Scale... in the Spectrogram view menu on page 2-73.	
		Marker...	Operates the markers. Refer to page 3-45 for how to use the markers.	
			Hor.	Inputs the horizontal position to move the □ marker. By default, it is positioned at the start point on the horizontal axis.
			Ver.	Inputs the slot number as the vertical position to move the □ marker. By default, it is positioned at slot 0.
			Delta Marker	Turns the delta marker on or off.
			Toggle Delta	Changes the □ and ◇ marker positions each other.
		Search...	Searches for the peak spectrum in the specified time slot and positions the □ marker there.	
			Peak	Searches the peak spectrum and moves the □ marker there. Rotate the general purpose knob clockwise to search the peak rightward, and vice versa.
			Max	Searches for the maximum peak spectrum and moves the marker there.
			Min	Searches for the minimum peak spectrum and moves the marker there.
Separation			Sets the minimum horizontal distance to separate two peaks. Refer to Separation in the Waveform view menu on page 2-68.	
Ver.			Inputs the slot number as the vertical position to move the □ marker. By default, it is positioned at slot 0.	
Delta Marker	Turns the delta marker on or off.			
Toggle Delta	Changes the □ and ◇ marker positions each other.			
Ver. Mag	Sets the number of vertical pixels to display one slot. The range is 1 to 10.			

CodeWPolar View Menu

Table 2–23 summarizes the view menu when you have defined the view as CodeWPolar in the CONFIG:VIEW menu.

This view displays IQ loci and chip positions according to the W-CDMA standard. For details on W-CDMA analysis, refer to page 3–127.

Table 2–23: CodeWPolar view menu table

Top level	Subordinate level, options and descriptions		
Source	Specifies the input data used for the view. Same as Source in the Polar view menu on page 2–76.		
Analysis Time Slot	Specifies the number of the time slot to display the IQ locus. The default is slot 0 which contains the latest data.		
Standard...	Configures the analyzer according to the standard digital modulating system settings.		
	W-CDMA 4.096M	Selects W-CDMA with the chip rate of 4.096 Mcpc.	
	W-CDMA 8.192M	Selects W-CDMA with the chip rate of 8.192 Mcpc.	
	W-CDMA 16.384M	Selects W-CDMA with the chip rate of 16.384 Mcpc.	
Manual Setup...	Sets the modulating system, chip rate, filter, and α /BT manually.		
	Modulation	Selects the modulating system required to demodulate the digitally-modulated signal.	
		W-CDMA	Selects W-CDMA system.
	Chip Rate	Inputs the chip rate: 4.096 M, 8.192 M, or 16.384 M.	
	Measurement Filter	Selects None (no filter) or RootRaisedCosine for the filter required to demodulate the digitally-modulated signal. Refer to <i>Processing Flow</i> on page 3–98 for detail.	
	Reference Filter	Selects None (no filter), RaisedCosine, or Gaussian for the filter required to create reference data. Refer to <i>Processing Flow</i> on page 3–98 for detail.	
	Alpha/BT	Inputs the α /BT value.	
	Auto Carrier	Determines whether to search the carrier automatically. Same as Auto Carrier in the Polar view menu on page 2–77.	
Symbol Constellation	Specifies how to display the constellation.		
	On	Displays the constellation for one short code specified with Options...→ Time Slot.	
	Off	Displays the constellation for all the signals.	

Table 2–23: CodeWPolar view menu table (cont.)

Top level	Subordinate level, options and descriptions		
Options...	Time Slot	Sets the number of the time slot displayed when Symbol Constellation is On. The range is 0 to the number of time slots -1.	
	Short Code	Sets the number of the short code displayed when Symbol Constellation is On. The range is 0 to 255.	
	Display	The polar view can display either measurement data or a reference signal, which has been demodulated and modulated in this view. Refer to <i>Processing Flow</i> on page 3–98 for detail.	
		Measure	Selects the measurement data for display.
		Reference	Selects the reference data for display.
	Format	Selects the display format.	
		Vector	Displays a data in vector format that represents chip-to-chip movements using a vector.
		Constellation	Displays data in constellation format that represents only chips.
Marker	Inputs the time to move the <input type="checkbox"/> marker.		
Hide LMS Part	Determines whether to hide or not the LMS in the last part of the data. <i>On</i> hides the LMS part, i.e. does not display the part.		
Analyze	Performs the measurement for all time slots on the data memory.		

CodeWPower View Menu

Table 2–24 summarizes the view menu when you have defined the view as CodeWPower in the CONFIG:VIEW menu.

According to the W-CDMA standard, this view displays each channel power measured for the symbol specified with Symbol in CodeWSpectrogram view menu. For details on W-CDMA analysis, refer to page 3–135.

Table 2–24: CodeWPower view menu table

Top level	Subordinate level, options and descriptions	
X Axis	Defines the parameter concerning the horizontal axis.	
	Short Code	Specifies that the horizontal axis represents short-code numbers.
	Symbol	Specifies that the horizontal axis represents symbol numbers. The display is for the channel on which the marker is positioned when the horizontal axis is short-code numbers.
	Time Slot	Specifies that the horizontal axis represents time slot numbers.
Average	Determines whether to average data or not.	
	Off	Specifies the data is not averaged.
	On	Displays the measurement result data averaged with Average Type and Num Averages below.
Average Type	Selects an average mode. This item is displayed when Average is set to On. Same as Average Type in the CodePower view menu on page 2–93.	
Num Averages	Specifies the number of slots to be averaged. The range is 1 to 10 ⁶ . If Average Type is set to RMS, slots specified with Num Averages are averaged before switching to a fixed display. If Average Type is set to RMSEpo, Num Averages is used for weighing old data. Refer to page 3–57 for details on averaging.	
Time Slot	Specifies the number of the time slot to be displayed. The default is the slot 0 which contains the latest data. This item appears when Average is set to Off.	
Symbol Rate	Composite/16k/ 32k/64k/128k/ 256k/512k/1024k	It is set to Composite by default that corresponds to multi-rate. When you select the other specific value, the measurement is done with the fixed rate.
Options...	Same as Options... in the CodePower view menu on page 2–93.	
Average Options...	Sets the averaging parameters and starts the process.	
	Begin Slot	Specifies the first slot to be averaged. The range is 0 to the number of time slots –1.
	End Slot	Specifies the last slot to be averaged. The range is 0 to the number of time slots –1.
	All Slots	Specifies that the averaging is done for all slots.
	Mkr -> Slot	Sets Begin Slot and End Slot with the marker and delta marker.
	Average Type	Same as Average Type above on the top menu level.
Execute	Executes averaging.	

3gppACPView Menu

Table 2–25 summarizes the view menu when you have defined the view as 3gppACPView in the CONFIG:VIEW menu. Use this view to measure ACP (Adjacent Channel Leakage Power) according to the 3GPP (3rd Generation Partnership Project) standard.

For details on 3GPP analysis, refer to page 3–143.

Table 2–25: 3gppACPView menu table

Top level	Subordinate level, options and descriptions		
Source	Selects input data for a view. You can select one of the following items:		
	D1 to D8	Specifies one of the data registers of D1 to D8 for an input source. Copy data to this register using Options...→ Copy To... in other view menus or Util C [Average] on a utility menu. <i>NOTE. The display data is always written into the D5 register. If you want to write another data, use a register other than D5.</i>	
Filter	Select on or off for a receive filter. The receive filter is a route Nyquist filter to extract the channels stipulated by the 3GPP standard. The filter-related parameters can be changed with Options...→ Scale, Marker, Search...→ Marker...→ ACP... described below.		
Average...	Sets up Average parameters. Same as Average... in the Waveform view menu on page 2–64.		
RBW...	Simulates Resolution Bandwidth (RBW) for compatibility with data measured by a conventional scanning RF spectrum analyzer. Same as RBW... in the Waveform view menu on page 2–65.		
Options...	Display Lines...	Controls the horizontal and vertical line markers. Same as Display Lines... in the Waveform view menu on page 2–65.	
	Copy To...	Copies the waveform currently being displayed to one of the destinations. Same as Copy To... in the Waveform view menu on page 2–66.	
	Copy From...	Loads text data from the file to which the waveform was copied using Copy To...	
	Hold Ver. Scale	Specifies whether you retain or reset the scale setting of the vertical axis when you change the input source. Same as Hold Ver. Scale in the Waveform view menu on page 2–66.	
	Scale, Marker, Search	Sets up scale-, marker-, and search-related parameters.	
		Scale...	Sets up the horizontal and vertical axes.
			Hor. Scale
Hor. Start			Sets the horizontal axis start value.
Ver. Scale			Sets the vertical axis scale.
Ver. Start	Sets the vertical axis start value.		
Full Scale	Sets the vertical scale to the default full-scale.		

Table 2-25: 3gppACPView menu table (cont.)

Top level	Subordinate level, options and descriptions																	
		<table border="1"> <tr> <td data-bbox="544 394 734 493">Marker...</td> <td data-bbox="734 394 1497 493">Operates the marker and the delta marker. The marker is represented as □, and the delta marker as □ and ◇. For how to use the markers, refer to page 3-45.</td> </tr> <tr> <td data-bbox="544 493 734 592">Hor.</td> <td data-bbox="734 493 1497 592">Specifies the horizontal position to which you move □. By default, □ is positioned at the start point of the horizontal axis.</td> </tr> <tr> <td data-bbox="544 592 734 640">Delta Marker</td> <td data-bbox="734 592 1497 640">Turns the delta marker on or off.</td> </tr> <tr> <td data-bbox="544 640 734 688">Toggle Delta</td> <td data-bbox="734 640 1497 688">Changes the □ and ◇ marker positions each other.</td> </tr> <tr> <td data-bbox="544 688 734 814">Mkr→Freq</td> <td data-bbox="734 688 1497 814">Sets the center frequency to the value at the current marker position. When you press this side key, the Freq, Span, Ref...→ Freq setting in the SETUP menu changes to the frequency at the current marker position.</td> </tr> <tr> <td data-bbox="544 814 734 913">Measurement</td> <td data-bbox="734 814 1497 913">Performs power measurement. Select one of the measurement types: Noise, Power, C/N, C/No, ACP and OBW. Refer to <i>Power Measurement</i> on page 3-81.</td> </tr> <tr> <td data-bbox="544 913 734 1228">ACP...</td> <td data-bbox="734 913 1497 1228"> <p>This menu item is displayed when you select ACP for Measurement.</p> <p>For the submenu Band Power Markers, SP, and BW, refer to <i>Band Power Marker Operations</i> on page 3-90.</p> <p>The submenu Filter is the same as that on the top menu level on page 2-100.</p> <p>For the submenu Filter Alpha, Filter SP, and Filter BW, see Figure 2-49 on page 2-102.</p> </td> </tr> <tr> <td data-bbox="544 1228 734 1323">OBW</td> <td data-bbox="734 1228 1497 1323">This menu item is displayed when you select OBW for Measurement. Set the ratio of the power in the specified band region to the power in the entire span region.</td> </tr> </table>	Marker...	Operates the marker and the delta marker. The marker is represented as □, and the delta marker as □ and ◇. For how to use the markers, refer to page 3-45.	Hor.	Specifies the horizontal position to which you move □. By default, □ is positioned at the start point of the horizontal axis.	Delta Marker	Turns the delta marker on or off.	Toggle Delta	Changes the □ and ◇ marker positions each other.	Mkr→Freq	Sets the center frequency to the value at the current marker position. When you press this side key, the Freq, Span, Ref...→ Freq setting in the SETUP menu changes to the frequency at the current marker position.	Measurement	Performs power measurement. Select one of the measurement types: Noise, Power, C/N, C/No, ACP and OBW. Refer to <i>Power Measurement</i> on page 3-81.	ACP...	<p>This menu item is displayed when you select ACP for Measurement.</p> <p>For the submenu Band Power Markers, SP, and BW, refer to <i>Band Power Marker Operations</i> on page 3-90.</p> <p>The submenu Filter is the same as that on the top menu level on page 2-100.</p> <p>For the submenu Filter Alpha, Filter SP, and Filter BW, see Figure 2-49 on page 2-102.</p>	OBW	This menu item is displayed when you select OBW for Measurement. Set the ratio of the power in the specified band region to the power in the entire span region.
Marker...	Operates the marker and the delta marker. The marker is represented as □, and the delta marker as □ and ◇. For how to use the markers, refer to page 3-45.																	
Hor.	Specifies the horizontal position to which you move □. By default, □ is positioned at the start point of the horizontal axis.																	
Delta Marker	Turns the delta marker on or off.																	
Toggle Delta	Changes the □ and ◇ marker positions each other.																	
Mkr→Freq	Sets the center frequency to the value at the current marker position. When you press this side key, the Freq, Span, Ref...→ Freq setting in the SETUP menu changes to the frequency at the current marker position.																	
Measurement	Performs power measurement. Select one of the measurement types: Noise, Power, C/N, C/No, ACP and OBW. Refer to <i>Power Measurement</i> on page 3-81.																	
ACP...	<p>This menu item is displayed when you select ACP for Measurement.</p> <p>For the submenu Band Power Markers, SP, and BW, refer to <i>Band Power Marker Operations</i> on page 3-90.</p> <p>The submenu Filter is the same as that on the top menu level on page 2-100.</p> <p>For the submenu Filter Alpha, Filter SP, and Filter BW, see Figure 2-49 on page 2-102.</p>																	
OBW	This menu item is displayed when you select OBW for Measurement. Set the ratio of the power in the specified band region to the power in the entire span region.																	

Table 2-25: 3gppACPView menu table (cont.)

Top level	Subordinate level, options and descriptions		
	Search...	Searches for the peak spectrum and places the □ marker there.	
		Peak	Searches the peak spectrum and moves the □ marker there. Rotate the general purpose knob clockwise to search the peak rightward, and vice versa.
		Max	Searches for the maximum peak spectrum and moves the □ marker there.
		Separation	Sets the minimum horizontal distance to separate two peaks. Refer to Separation in the Waveform menu on page 2-68.
		Delta Marker	Turns the delta marker on or off.
		Toggle Delta	Changes the □ and ◇ marker positions each other.
		Mkr->Freq	Sets the center frequency to the value at the current marker position. When you press this side key, the Freq, Span, Ref... → Freq setting changes to the frequency in the current marker position.

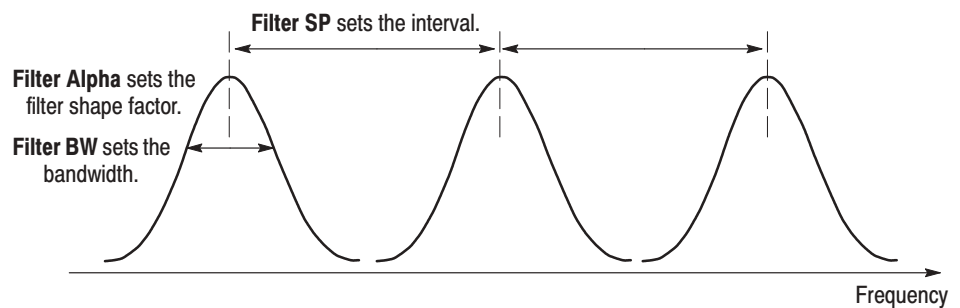

Figure 2-49: Setting the receive filter with the ACP... submenu

3gppSpectrogram View Menu

3gppSpectrogram view menu is the one when you have defined the view as 3gppSpectrogram in the CONFIG:VIEW menu.

According to the 3GPP (3rd Generation Partnership Project) standard, this view displays each channel power measured for each slot in color with channel along the horizontal axis and slot (time) along the vertical axis.

The menu is the same as the CodeWSpectrogram view menu on page 2–95.

For detail on the 3GPP analysis, refer to page 3–143.

3gppPolar View Menu

Table 2–12 summarizes the view menu when you have defined the view as 3gppPolar in the CONFIG:VIEW menu.

This view displays IQ loci and chip positions according to the 3GPP standard. For detail on 3GPP analysis, refer to page 3–143.

Table 2–26: 3gppPolar view menu table

Top level	Subordinate level, options and descriptions		
Source	Specifies the source data for the view. Same as Source in the Polar view menu on page 2–76.		
Analysis Time Slot	Specifies the number of the time slot to display the IQ locus. The default is slot 0 which contains the latest data.		
Standard...	Configures the analyzer according to the standard digital modulating system settings.		
	W-CDMA	Selects the W-CDMA standard with the chip rate of 3.84 Mcpc.	
Manual Setup...	Sets the modulating system, chip rate, filter, and α /BT manually.		
	Modulation	Selects the modulating system required to demodulate the digitally-modulated signal.	
		W-CDMA	Selects the W-CDMA system.
	Chip Rate	Inputs the chip rate required to demodulate the digitally-modulated signals.	
	Measurement Filter	Selects the filter required to demodulate the digitally-modulated signal. You can select either None (no filter) or RootRaisedCosine. Refer to <i>Processing Flow</i> on page 3–98 for detail.	
	Reference Filter	Selects None (no filter), RaisedCosine, or Gaussian for the filter required to create reference data. Refer to <i>Processing Flow</i> on page 3–98 for detail.	
	Alpha/BT	Inputs the α /BT value. The range is 0.0001 to 1.	
Symbol Constellation	Auto Carrier Determines whether to search the carrier automatically. Same as Auto Carrier in the Polar view menu on page 2–77.		
	Specifies how to display the constellation.		
	On	Displays the constellation for one short code.	
	Off	Displays the constellation for all signals.	

Table 2-26: 3gppPolar view menu table (cont.)

Top level	Subordinate level, options and descriptions	
Options...	Scrambling Code Search	Determines whether or not to search for the scrambling code to analyze the down-link signal.
		On (default) Searches for the scrambling code to analyze the down-link signal.
		Off Uses the scrambling code specified with Scrambling Code below to analyze the down-link signal. <i>NOTE. The analyzer detects the three channels of P-SCH, S-SCH, and PCPICH to establish the synchronization and correct the frequency and phase for the down-link signal analysis. If these channel levels are too low to be detected, the analyzer cannot make measurement correctly. This error occurs when one of these channel levels is less than about 1/10th the sum of other channel levels. In this case, set Scrambling Code Search to Off and specify the scrambling code with Scrambling Code just below.</i>
	Scrambling Code	Specifies the scrambling code when you set Scrambling Code Search just above to Off. The analyzer uses the specified code instead of searching for it to analyze the down-link signal.
	Time Slot	Sets the number of the time slot to be displayed when Symbol Constellation is On. The range is 0 to the number of time slots - 1.
	Symbol Rate	Sets the symbol rate to display symbol constellation: 960K, 480K, 240K, 120K, 60K, 30K, 15K, 7.5K, or Composite. Composite corresponds to multi-rate.
	Short Code	Sets the number of the short code to be displayed when Symbol Constellation is On. The range is 0 to 255.
	Hide SCH Part	Determines whether to hide or not the SCH in the first part of the data. <i>On</i> hides the SCH part, i.e. does not display the part.
	Display	Selects the display data. Same as Display in the Polar view menu on page 2-78.
	Format	Selects the display format. Same as Display in the Polar view menu on page 2-78.
Marker	Inputs the time to move the <input type="checkbox"/> marker.	
Analyze	Performs the measurement for all time slots on the data memory.	

3gppPower View Menu

3gppPower view menu is the one when you have defined the view as 3gppPower in the CONFIG:VIEW menu.

According to the 3GPP standard, this view displays each channel power measured for the symbol specified with Time Slot in the 3gppSpectrogram view menu. For detail on the 3GPP analysis, refer to page 3–143.

The menu is the same as the CodeWPower view menu on page 2–99.

For detail on the 3GPP analysis, refer to page 3–143.

GSM View Menu

Table 2–27 summarizes the view menu when you have defined the view as GSM in the CONFIG:VIEW menu.

This view controls measurement according to the GSM (Global System for Mobile Communication) standard. For details on GSM analysis, refer to page 3–151.

NOTE. *The GSM view is designed to work only in View D for the GSM analysis. When you perform GSM measurement, select **GSM Measurement** in the CONFIG:MODE menu or define View D as GSM.*

Table 2–27: GSM view menu table

Top level	Subordinate level, options and descriptions	
Measurement	Selects the measurement item.	
	Mod.Accuracy	Selects the modulation accuracy measurement.
	OutputPower	Selects the mean carrier power measurement
	PowerVSTime	Selects the power vs. time measurement
	Spectrum (MOD)	Selects the ACP measurement for a continuous modulation spectrum
	Spectrum (SW)	Selects the ACP measurement for a switching transient spectrum
Burst Count	Specifies the number of bursts to acquire. The range is 1 to 4000. This menu is available when Measurement is set to OutputPower, Spectrum (MOD), and Spectrum (SW).	
Measure	Starts to acquire and process data. Use the ROLL or BLOCK key to stop acquisition.	
Analyze	Processes the data acquired on the memory or loaded from a file. If you want to discontinue the analysis, press the ROLL or BLOCK key.	
Burst No.	Specifies the number of the burst to display. This menu is shown when the number of bursts determines after pressing the Analyze side key. This menu is not available when Measurement is set to Spectrum (SW).	

GSMPolar View Menu

Table 2–28 summarizes the GSMPolar view menu displayed when you select **GSM Measurement** in the CONFIG:MODE menu or define View D as GSM.

This view displays IQ loci and symbol positions according to the GSM (Global System for Mobile Communication) standard. For details on GSM analysis, refer to page 3–151.

Table 2–28: GSMPolar view menu table

Top level	Subordinate level, options and descriptions	
Source	Specifies the source data for the view. Same as Source in the Polar view menu on page 2–76. <i>NOTE. Use the default setting (Active) for the GSM measurement.</i>	
Frame	Specifies the number of the frame to display. Same as Frame in the Polar view menu on page 2–76. <i>NOTE. Use the default setting (0) for the GSM measurement.</i>	
Standard...	Configures the analyzer according to the standard digital modulating system settings.	
	GSM	Configures the analyzer according to GSM (Global System for Mobile Communication).
Manual Setup...	Sets the modulating system, symbol rate, filter, and α /BT manually. For the menu items, refer to Manual Setup... in the Polar view menu on page 2–76. <i>NOTE. Use the following default settings for the GSM measurement.</i>	
	Modulation	GMSK
	Symbol Rate	270.833 K
	Measurement Filter	None
	Reference Filter	Gaussian
	Alpha/BT	0.3
	Auto Carrier	On
Burst...	Sets the burst search parameters. Same as Burst... in the Polar view menu on page 2–77. <i>NOTE. Use the following default settings for the GSM measurement.</i>	
	Number Frames	1
	Search	Off
	Block Size	4
	Peak Threshold	–40
	Threshold	–20 dB
	Offset	0

Table 2–28: GSMPolar view menu table (cont.)

Top level	Subordinate level, options and descriptions	
Sync Word...	Specifies the sync word. For details on entering the sync word, refer to page 3–163.	
Sync Word Search	<p>Determines whether or not to search the sync word. It defaults to <i>Off</i>. However, for the GSM measurement, the analyzer always turns Sync Word Search <i>On</i>.</p> <p>When it is set to <i>On</i>, specify the sync word parameters using the submenus described below.</p> <p><i>NOTE. If the analyzer does not find the sync word, no waveform is displayed.</i></p>	
Differential Encoding	Determines whether or not to use the differential encoding. It defaults to <i>Off</i> . However, for the GSM measurement, the analyzer always turns Differential Encoding <i>On</i> .	
Sync Word Pattern	TSC0 to TSC7	<p>Selects the pre-defined sync word pattern in the GSM standard.</p> <p>TSC0: 25C225C TSC4: 1AE41AC TSC1: 2DDE2DC TSC5: 4EB04E8 TSC2: 43BA438 TSC6: A7D7A7C TSC3: 47B4478 TSC7: EF12EF0</p> <p><i>Note: The sync word is reset to TSC0 (default) when you change the measurement item with the Measurement side key in the GSM view menu.</i></p>
	User	<p>Uses the user-defined sync word.</p> <p>Set the sync word with the Sync Word Entry... menu below.</p>
Sync Word Entry...	Sets the sync word in hexadecimal numbers.	
	OK	Accepts the entry.
	Position	Moves the cursor in the Sync Word field on the screen to input a number.
	Delete Char	Deletes the character at the cursor.
	0 1 2 3...	Inputs a number from 0 to 3.
	4 5 6 7...	Inputs a number from 4 to 7.
	8 9 A B...	Inputs a number from 8 to B.
Sync Word Length	Sets the sync word length in bits when Sync Word Pattern is set to User . It is fixed to 26 for TSC0 to TSC7. See Figure 2–50. If this length is greater than that of the user-defined word, the remaining lower bits are set to 0. If this length is less than that of the user-defined word, the remaining lower bits are ignored.	
	Sync Word Position	Sets the sync word position in bits for waveform display. See Figure 2–50. For the GSM measurement, the analyzer always set it to 61 (default).
Analysis Length	Sets the data length in bits for analysis and display. See Figure 2–50. For the GSM measurement, the analyzer always set it to 148 (default).	

Table 2-28: GSMPolar view menu table (cont.)

Top level	Subordinate level, options and descriptions	
Options...	Display	Selects the measurement or reference data for display. Same as Display in the Polar view menu on page 2-78. <i>NOTE. Use the default setting (Measurement) for the GSM measurement.</i>
	Format	Selects the vector or constellation format for display. Same as Format in the Polar view menu on page 2-78. <i>NOTE. Use the default setting (Vector) for the GSM measurement.</i>
	Marker	Inputs the time to move the <input type="checkbox"/> marker.
	Position	Specifies the number of the frame to be displayed after a trigger event. If this frame number agrees with the trigger position specified with Setup → Trigger... → Pos, the frame for which a trigger is generated is displayed. By default, Position is set to zero (current frame).

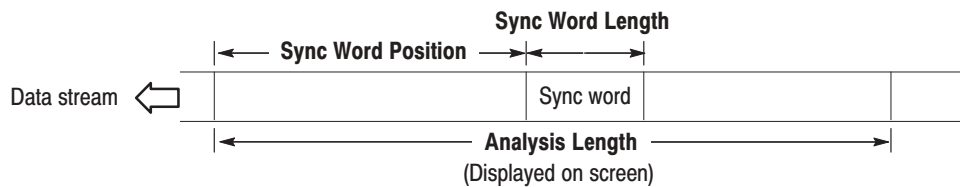

Figure 2-50: Setting the sync word parameters

GSMMask View Menu

Table 2–29 summarizes the view menu shown when you select **PowerVSTime** in the **Measurement** menu item of the GSM view menu (refer to page 2–107).

The GSMMask view displays the Power vs. Time Pass/Fail test according to the GSM (Global System for Mobile Communication) standard. For details on GSM analysis, refer to page 3–151.

Table 2–29: GSMMask menu table

Top level	Subordinate level, options and descriptions	
Source	Selects input data for a view. You can select one of the following items:	
	D1 to D8	The default is D1. For the power vs. time measurement in GSM, the analyzer always writes waveform data in the D1 register.
Mask	Determines whether or not to execute the Power vs. Time Pass/Fail test using the specified mask. For the GSM measurement, the analyzer always turns Mask <i>On</i> .	
Mask Setup...	This menu is for future use. At present, although you can create a mask with this menu, the analyzer always uses the specified mask in the GSM standard regardless of your settings. So, this manual does not explain how to create a mask.	
Options...	Same as Options... in the Analog view menu on page 2–70.	
Rising Edge	Expands the rising edge of the waveform horizontally on screen.	
Falling Edge	Expands the falling edge of the waveform horizontally on screen.	
Full Scale	Sets the horizontal scale to full-scale to display all data on the memory.	

CCDF Menu

Table 2–30 summarizes the menu when you have defined the view as CCDF in the CONFIG:VIEW menu.

For CCDF analysis, refer to page 3–165.

Table 2-30: CCDF menu table

Top level	Subordinate level, options and descriptions			
Source	Specifies the source data for the view. Same as Source in the Polar view menu on page 2-76.			
Frame	Specifies the number of the frame to be displayed. By default, it is set to frame 0 into which the current data is written.			
Options...	Position	Specifies the number of the frame to be displayed after a trigger event occurs. If this frame number agrees with the trigger position specified with Setup → Trigger... → Pos, the frame for which the trigger is generated is displayed. By default, Position is set to zero (current frame).		
	Hold Ver. Scale	Specifies whether you retain or reset the scale setting of the vertical axis when you change the input source. Same as Hold Ver. Scale in the Waveform view menu on page 2-66.		
	Scale, Marker, Search...	Scale...	Sets up the horizontal and vertical axes.	
			Hor. Scale	Sets the horizontal axis scale.
			Hor. Start	Sets the horizontal axis start value.
			Ver. Stop	Sets the vertical axis stop value.
			Ver. Start	Sets the vertical axis start value.
			Auto Scale	Automatically sets the vertical scale to display the whole waveform.
Full Scale	Resets the vertical scale to the default.			
Frame Relative	Specifies whether the origin of the time axis for each frame is set to zero. Same as Frame Relative in the Waveform view menu on page 2-66.			
Marker...	Operates the marker and the delta marker. Same as Marker... in the Analog view menu on page 2-70.			
Search...	Searches for the peak spectrum and places the □ marker there. Same as Search... in the Analog view menu on page 2-70.			
Output Format	Selects CCDF or Histogram for the display format.			
Resolution	Sets the resolution for the histogram when Output Format is set to Histogram. The range is 0.01 dB to 10 dB in 1-2-5 steps.			
Destination	Specifies the destination data register from D1 to D8. The default is D1. <i>NOTE. When another digital demodulating system such as cdmaOne or W-CDMA is active, use D1 to D4.</i>			
Calculate...	Sets the CCDF calculation parameters or starts the process.			
	Begin Frame	Specifies the first frame to be calculated. The range is 0 to the number of frames -1.		
	End Frame	Specifies the last frame to be calculated. The range is 0 to the number of frames -1.		
	All Frames	Specifies that the data is calculated for all frames.		
	Mkr → Frame	Sets Begin Frame and End Frame with the marker and delta marker.		
Execute	Executes the calculation.			
Reset	This menu item is displayed during data acquisition. It restarts the CCDF calculation.			

CCDFView Menu

Table 2–30 summarizes the view menu when you have defined the view as CCDFView in the CONFIG:VIEW menu.

For CCDF analysis, refer to page 3–165.

Table 2–31: CCDFView menu table

Top level	Subordinate level, options and descriptions			
Source	Specifies the source data for the view.			
	D1/D2/D3/D4/ D5/D6/D7/D8	Selects a data register. Choose the same register as Destination in the CCDF view (refer to page 2–113).		
Options...	Copy To...	Copies the waveform currently being displayed to one of the following destinations. Same as Copy To... in the Waveform view menu on page 2–66.		
	Copy From...	Loads text data from the file to which the waveform was copied using Copy To....		
	Scale, Marker, Search...	Scale...	Sets up the horizontal and vertical axes.	
			Hor. Scale	Sets the horizontal axis scale.
			Hor. Start	Sets the horizontal axis start value.
			Ver. Stop	Sets the vertical axis stop value.
			Ver. Start	Sets the vertical axis start value.
Full Scale	Resets the vertical scale to the default.			
Marker...	Operates the marker and delta marker. Same as Marker... in the Analog view menu on page 2–70.			
Search...	Searches for the peak spectrum and places the <input type="checkbox"/> marker there. Same as Search... in the Analog view menu on page 2–70.			

AutoSave Menu

Table 2–30 summarizes the view menu when you have defined the view as AutoSave in the CONFIG:VIEW menu. The auto-save function stores captured data to files while acquiring the data.

For details, refer to *Auto-Save Function* on page 3–169.

Table 2–32: AutoSave menu table

Top level	Subordinate level, options and descriptions	
Mode	RollSave	Stores the data acquired in the Roll mode.
	BlockSave	Stores the data acquired in the Block mode.
File Name	Specifies the name of the file to store the data.	
Save Frames	Sets the number of frames to be stored in the RollSave mode.	
Counter Reset	Resets the file counter. When you acquire data next time, the file name is suffixed to zero.	

SelfCal (Util A) Menu

Controls the self gain-calibration.

For details on the operation, refer to *Calibration* on page 3–174.

Table 2–33: SelfCal menu table

Top level	Subordinate level, options and descriptions
Auto Gain Cal	When set to On, the analyzer will automatically run the internal calibration routines.
Gain Cal	Runs the auto-calibration.
IQ Offset Cal	Compensates offset of I/Q input signals.
Wide IQ Balance Cal	Corrects DC balance of I/Q signals in the Wide IF mode.

SaveLoad (Util B) Menu

Controls saving and loading files.

For details on the operation, refer to *Saving and Loading Files* on page 1–20.

Table 2–34: SaveLoad menu table

Top level	Subordinate level, options and descriptions		
Save...	Saves the contents of the data memory to a file.		
	Source	Specifies the input data to be saved.	
		None	Specifies no input source.
		Active	Specifies the data memory storing acquired data for the input source.
		Zoom	Specifies the zoomed data for the input source.
		D1 to D8	Specifies one of the data registers of D1 to D8 for the input source. Before saving the data, copy the data to this register using Options...→ Copy To... in other view menus or Util C [Average] on a utility menu.
		File (*.IQ)	Specifies the IQ-formatted data file for the input source. On accessing files, refer to <i>File Access Menu</i> on page 2–119.
	File (*.AP)	Specifies the AP-formatted data file for the input source. On accessing files, refer to <i>File Access Menu</i> on page 2–119.	
	Begin Frame	Specifies the first frame for saving.	
	End Frame	Specifies the last frame for saving. With the beginning and end frames specified, only the frames of this data range are saved. The specified frame number may be 0 to (block size – 1), or to (trigger count × block size – 1) if you set a trigger.	
	All Frames	Specifies that the data in all frames is saved.	
Mkr→Frame	Sets the frame at the marker position to End Frame.		
Save To File (*.IQ)	Saves the data to a file in the IQ format.		
Save To File (*.AP)	Saves the data to a file in the AP format. The data saved in AP format is unavailable for modulation analysis or zoom.		
Load...	Loads data from a file to the data memory.		
	Load From File (*.IQ)	Loads the data from the file that contains it in the IQ format.	
	Load From File (*.AP)	Loads the data from the file that contains it in the AP format.	

Average (Util C) Menu

Controls averaging.

For details on the operation, refer to *Average and Peak Hold* on page 3–57.

Table 2–35: Average menu table

Top level	Subordinate level, options and descriptions	
Source	Selects the input source.	
	None	Specifies no input source.
	Active	Specifies the data memory storing acquired data for the input source.
	Zoom	Specifies the zoomed data for the input source. Refer to <i>Zoom</i> on page 3–51.
	File(*.IQ)	Specifies the IQ-formatted data file for the input source. On accessing files, refer to <i>File Access Menu</i> on page 2–119.
	File(*.AP)	Specifies the AP-formatted data file for the input source. On accessing files, refer to <i>File Access Menu</i> on page 2–119.
Begin Frame	Specifies the first frame for averaging.	
End Frame	Specifies the last frame for averaging.	
	With the beginning and end frames specified, only the frames of this data range are averaged. The specified frame number may be 0 to (block size – 1), or to (trigger count × block size – 1) if you set a trigger.	
Destination	Selects one of the D1 to D8 data registers as the destination for storing the result. The default is D1.	
Mkr→Frame	Sets the frame in the marker position to End Frame.	
RMS	Performs the averaging with RMS (root-mean-square).	
PeakHold	Performs the peak hold.	

File Access Menu

The File Access menu is called from the File (*.XXX) submenu item of any other menus, and then displayed together with the directory and file lists. The file extension XXX indicates CFG, IQ, or AP. Refer to *File Menu Operations* on page 3–178 for details.

Table 2–36: File Access menu table

Top level	Subordinate level, options and descriptions	
Cancel	Returns to the menu calling the File Access menu.	
OK	Once you have selected a file, press the OK side key to accept the file.	
File	Selects a file.	
Dir	Selects a directory.	
Expand Dir	Lists the files in the selected directory or shows the directory listing.	
Drive	Selects a drive.	
Name Entry...	Inputs the file name or directory name.	
	Position	Press this side key and use the general purpose knob to move the caret within the file name input field.
	Delete Char	Press this side key to delete the character placed in the caret position within the input field. When the caret is not displayed, the last character is deleted each time you press this side key.
	A B C D E F G H...	When you press one of these side keys, you receive a submenu in which a character is assigned to each side key. Press the side key showing the character you want to input.
	I J K L M N O P...	
	Q R S T U V W X...	
	Y Z 0 1 2 3 4 5...	
6 7 8 9 . _ \ :...		
Operation...	Operates a file. Refer to <i>File Menu Operations</i> on page 3–178 for details.	
	Copy File...	Copies a file.
	Delete File...	Deletes a file.
	Create Dir...	Creates a new directory.
	Delete Dir...	Deletes a directory.

Print Menu

Makes a hardcopy of the screen display with the **PRINT** key on the front panel.
For detail, refer to *Hardcopy* on page 3–202.

Table 2–37: Print menu table

Top level	Subordinate level, options and descriptions
Cancel	Returns to the menu previously displayed.
Printer	Selects a printer.
Print To Printer	Performs a hardcopy.
Save To File (*BMP)	Saves the hardcopy to a file.

Changing the Power-Up Settings

If you want to start the analyzer with particular settings other than the factory default, save the settings to the system file *init.cfg* using the following steps.

1. Set the analyzer to the power-up condition as you desire.
2. Press CONFIG:MODE → [Config]← (the top side key) to display the Config menu.
3. Press the side key **Power On...** → **Save To INIT.CFG** in order.

The current settings are saved to the system file *init.cfg*.

The analyzer will start with the settings saved in the system file *init.cfg* from the next power-on.

Restoring the Factory Default

When you return the power-up settings to the factory default, do the following procedure.

1. Press CONFIG:MODE → [Config]← (the top side key) to display the Config menu.
2. Press the side key **Power On...** → **Return To Defaults** in order.

The analyzer will start with the factory default from the next power-on.

Reference

Input and Memory Modes

There are several input frequency bands: RF (for WCA330)/RF1 to RF4 (for WCA380), Baseband, and IQ. There are three intermediate frequency (IF) modes: Normal, HiRes, and Wide. There are four modes in which data is written into memory: Scalar, Frequency, Dual, and Zoom. When you configure the analyzer, you must begin with modes. When you change modes, most old settings are replaced with the defaults.

This section explains the function of each mode and how to set them.

Selecting the Input Frequency Band

Figure 3–1 shows a rough signal process flow from inputting a signal to writing it into data memory. You can select the frequency range of input signals using **SETUP:MAIN** → **Band**. Table 3–1 shows the frequency ranges.

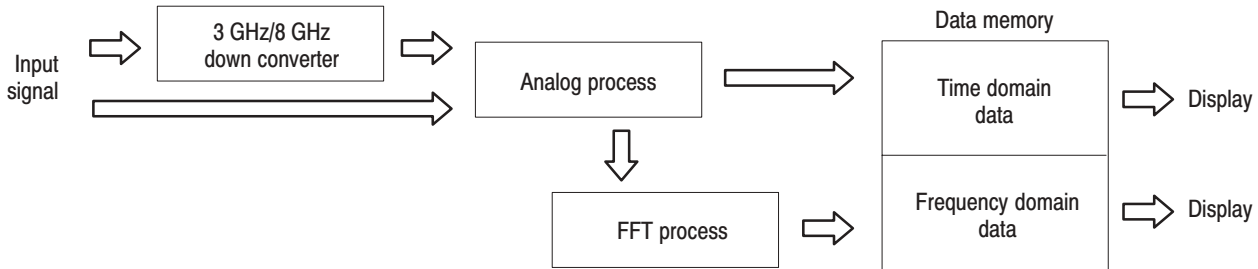

Figure 3–1: Signal process flow

Table 3–1: Input frequency band

Band	Frequency range
Baseband	0 to 10 MHz
RF (WCA330)	10 MHz to 3 GHz (IF mode: Normal, HiRes)
RF1 (WCA380)	50 MHz to 3 GHz (IF mode: Wide)
RF2 (WCA380)	2.5 GHz to 3.5 GHz
RF3 (WCA380)	3.5 GHz to 6.5 GHz
RF4 (WCA380)	5.0 GHz to 8.0 GHz
IQ	Use the I/Q signals from the rear IQ input connectors.

Baseband Mode. This mode can process data within a span of DC to 10 MHz (the number of FFT points = 1024) or 5 MHz (the number of FFT points = 256) per frame. This mode does not use the internal down-converter.

RF Mode. This mode uses the internal down-converter to process 10 MHz to 3 GHz (for WCA330)/8 GHz (for WCA380) signals. Generally, with a span of up to 6 MHz, data is acquired in one logical frame by one scan. If a span is greater than 6 MHz, data is acquired in one frame by two or more scans. The analyzer is configured to process data within a span of up to 3 GHz. For example, if the span is set to 3 GHz, data is acquired in one logical frame by 600 scans.

NOTE. Physical Frame and Logical Frame — *There are two types of frame: physical frame containing scanned data and logical frame containing display data. In the RF mode, with the span above 6 MHz, one logical frame consists of several physical frames. With the span below 6 MHz, one physical frame corresponds to one logical frame, called “Vector mode”.*

IQ Mode. I and Q signals input through the I and Q INPUT connectors on the rear panel are processed by the wide bandwidth signal processing. Spans can be expanded to 30 MHz.

For the relationship between modes and spans, refer to Table 3–3 on page 3–7.

Selecting the IF Mode

Analog and FFT processing of input signals depends on the Intermediate Frequency (IF) mode. You can select one of the three IF modes by using **SETUP:MAIN → IF Mode**.

Table 3–2: IF modes

IF mode	IF bandwidth	Feature	Application
Normal	10 MHz	High degree of phase flatness	General measurement Digital modulation analysis
HiRes	6 MHz	Wide dynamic range	ACP measurement Spurious measurement
Wide	32 MHz	Wide IF bandwidth	Modulation analysis of wide bandwidth signals W-CDMA analysis

Normal Mode. This mode has an IF bandwidth of 10MHz and features a high degree of phase flatness. It is suitable for digital modulation analysis with a span below 6 MHz, or general measurement that does not require a wide dynamic range. FFT in this mode is faster than the HiRes mode because it is performed by hardware. When the memory mode is set to Dual or Zoom, you can select software processing FFT.

You can specify the Normal mode when the input frequency band is set to Baseband or RF (for WCA330)/RF1 to 4 (for WCA380).

HiRes Mode. This mode has a relatively narrow IF bandwidth of 6 MHz, but has the widest dynamic range. It is suitable for ACP and spurious measurement. FFT is slow because it is always performed by software.

You can specify the HiRes mode when the input frequency band is set to RF (for WCA330)/RF1 to 4 (for WCA380).

Wide Mode. This mode has an IF bandwidth of 32 MHz, which is the widest of all the three modes. It is suitable for modulation analysis of wide bandwidth signals or code-domain analysis of W-CDMA. A span can be expanded to maximum 30 MHz per frame.

You can specify the Wide mode when the input frequency band is set to RF (for WCA330)/RF1 to 4 (for WCA380).

Memory Modes: Scalar, Frequency, Dual, and Zoom

If the number of FFT points is set to 1024 or 256, the data memory for up to 4,000 or 16,000 frames can be allocated respectively (see Figure 3–2). The following four modes can be available depending on memory or frame usage.

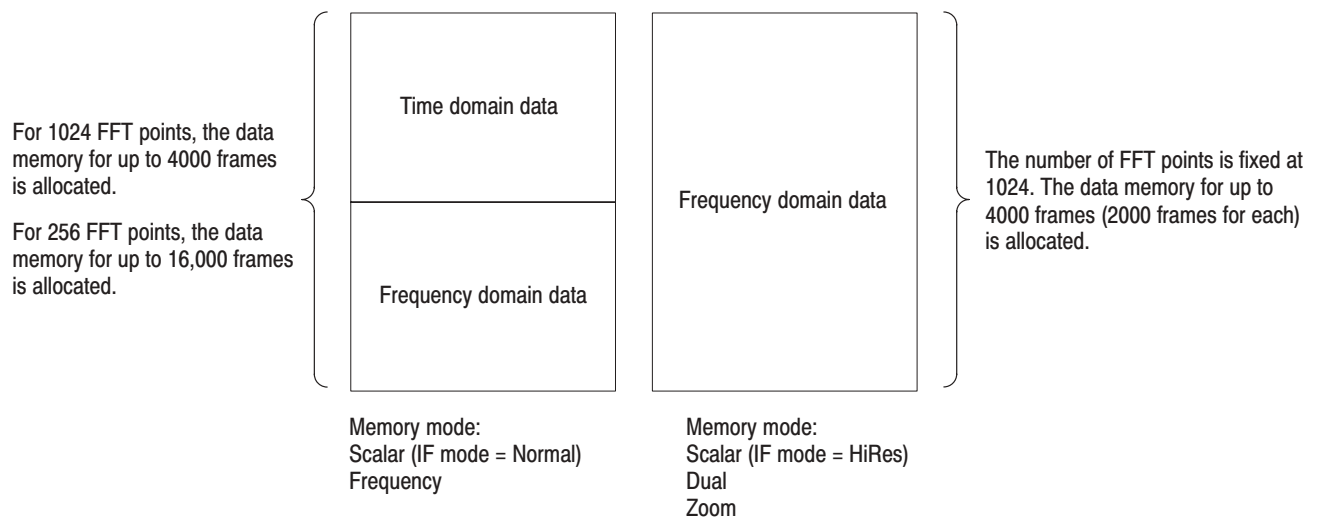

Figure 3–2: Usage of data memory

Frequency Mode. Only frequency domain data is written into every frame (Refer to Figure 3–2). This mode enables the analyzer to capture signals of twice the length possible in the Dual or Zoom mode. Up to 10 MHz span is allowed.

Scalar Mode. The above Frequency mode is switched to the Scalar mode when the input mode is set to RF and the span is above 6 MHz. One logical frame comprises data acquired by several scan so that up to 3 GHz span can be processed. For example, with a span of 3 GHz, one frame comprises data acquired through 600 scans (refer to *RF Mode* on page 3–3).

Dual Mode. Frequency and time domain data is written concurrently into memory (see Figure 3–2). The block size (the number of frames) for each domain is reduced to half. You can set the frame period to any value. The number of FFT points is fixed at 1024.

Zoom mode. Frequency and time domain data is written concurrently into memory (see Figure 3–2). The block size (the number of frames) for each domain is reduced to half. In the Zoom mode, the frame period is fixed so that frames are acquired continuously. As to the acquired signals, you can change the settings of the center frequency and the span within their original ranges to display them again. The number of FFT points is fixed at 1024.

For frame period, refer to *Frame Period and Real Time* on page 3–25.

Setting the Mode

Setting a Basic Configuration Pattern

You can use the CONFIG:MODE menu to set a basic configuration pattern for the analyzer, including the input and memory modes. For the default values of the basic configuration patterns, refer to Appendix C.

1. Press the CONFIG:MODE key on the front panel.
2. Select a basic configuration pattern. For example, press the **Dual** side key to configure the analyzer for the Dual mode, or press the **Zoom** side key for the Zoom mode.

For details on menus, refer to *CONFIG Menu* on page 2–48.

Changing Modes

Use the following procedure to change the input and memory modes.

1. Select an input frequency band:
 - a. Press SETUP:MAIN → **Band**.
 - b. Use the general purpose knob to select the band you prefer from Baseband, RF (for WCA330)/RF1 to 4 (for WCA380), and IQ.
2. Select an IF mode:
 - a. Press the **IF Mode** side key.
 - b. Use the general purpose knob to select the mode from Normal, HiRes, and Wide.
3. Select a memory mode:
 - a. Press the side key **Memory Mode, Input, FFT...** → **Memory Mode**.
 - b. Use the general purpose knob to select the mode from Frequency, Dual, and Zoom.

There is no Scalar mode selection. The mode is automatically set when you set a span to 10 MHz or more. For how to set spans, refer to page 3–9.

Mode Summary

Table 3–3 summarizes the relationship among modes, spans and frame periods. For details on frame period, refer to *Frame Period and Real Time* on page 3–25.

Table 3–3: Mode summary

Input band	IF mode	Memory mode	Max span ¹	Frame period	F/T write ²	Zoom
Baseband	Normal	Frequency	10 MHz ³	Optionally set	F only	Disabled
		Dual	10 MHz	Optionally set	F/T	Disabled
		Zoom	5 MHz	Consecutive (not settable)	F/T	Enabled
RF (WCA330) RF1 to RF4 (WCA380)	Normal	Scalar ⁴	3 GHz ⁵	Optionally set	F only	Disabled
		Frequency	6 MHz	Optionally set	F only	Disabled
		Dual	6 MHz	Optionally set	F/T	Disabled
		Zoom	5 MHz	Consecutive (not settable)	F/T	Enabled
	HiRes	Scalar ⁴	3 GHz	Optionally set	F only	Disabled
		Dual	5 MHz	Optionally set	F/T	Disabled
		Zoom	5 MHz	Consecutive (not settable)	F/T	Enabled
Wide	Zoom	30 MHz	Consecutive (not settable)	F/T	Enabled	
IQ	Wide	Zoom	30 MHz	Consecutive (not settable)	F/T	Enabled

¹ Maximum span per frame.

² F and T represent the frequency and time domain data, respectively.

³ The number of FFT points is 1024. When it is 256, the maximum span is 5 MHz.

⁴ The mode is switched to Scalar by setting the span to 10 MHz or larger.

⁵ 1 GHz when the input band is RF2.

The RF mode is switched to the Scalar mode when you set the span to 10MHz or higher. If you set the span to 6 MHz or lower, the original settings are restored and display resumes.

NOTE. *The data disappears if you set the data memory mode to Dual or Zoom to display time domain data in a view.*

Usually, you observe signals using the Scalar mode, in which a wide span is used. When you want to observe detailed phenomena around a particular center frequency, you can use the Dual or Frequency mode. Use the Zoom mode to examine phenomena in the frequency domain in more detail.

Scalar mode

- Acquires signals in a wide span of 10 MHz to 3 GHz.

Frequency mode

- Acquires signals in a span below 10 MHz for a long time.
- Acquires signals in real-time (depending on the frame period).

Dual mode

- Analyzing analog or digital modulation.
- Acquires signals in real-time (depending on the frame period).

Zoom mode

- Enlarging a particular frequency domain.

Frequency and Span

You can set a frequency and span with the SETUP menu using the general purpose knob or keypad on the front panel. You can also set a frequency and span using the marker and search functions. See Figure 3–3.

Setting Frequency and Span

Set a frequency and span with the SETUP keys on the front panel. There are two ways to set the keys:

- Press **SETUP:MAIN** → **Freq, Span, Ref...** → **Freq** or **Span** and enter the value using the general purpose knob or keypad.
- Press **SETUP:Freq** or **SETUP:Span** and enter the value using the general purpose knob or keypad.

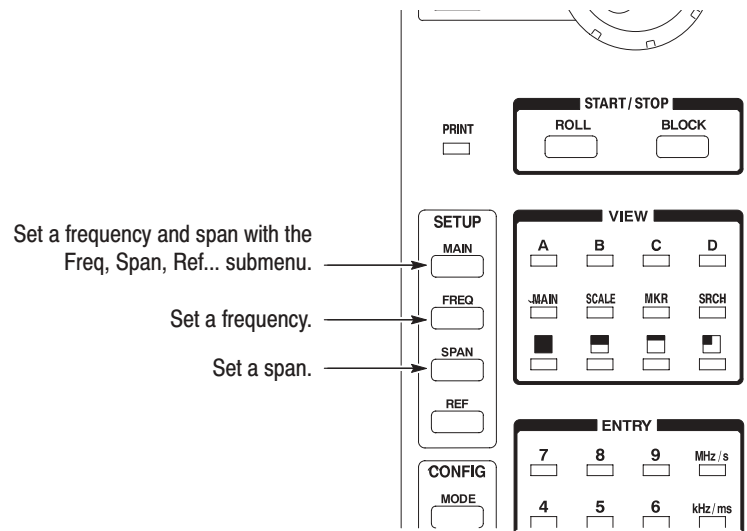

Figure 3–3: SETUP keys for setting the frequency and span

Setting Range The upper limit of the span depends on the mode as shown in Table 3–4.

Table 3–4: Frequency and span setting range

Band	IF mode	Memory mode	Maximum span ¹	Frequency range
Baseband	Normal	Frequency	10 MHz ²	DC to 10 MHz
		Dual	10 MHz	
		Zoom	5 MHz	
RF (WCA330) RF1 to RF4 (WCA380)	Normal	Scalar ³	3 GHz ⁴	10 MHz ⁵ to 3 GHz
		Frequency	6 MHz	(RF, RF1)
		Dual	6 MHz	2.5 GHz to 3.5 GHz
		Zoom	5 MHz	(RF2)
	HiRes	Scalar	3 GHz	3.5 GHz to 6.5 GHz
		Dual	6 MHz	(RF3)
		Zoom	5 MHz	5.0 GHz to 8.0 GHz
Wide	Zoom	30 MHz	(RF4)	
IQ	Wide	Zoom	30 MHz	–

- ¹ **The maximum span per frame.**
- ² **10 MHz when the number of FFT points is 1024.
5 MHz when the number of FFT points is 256.**
- ³ **If you set the span to 10 MHz or more, the mode changes to the Scalar automatically.**
- ⁴ **1 GHz only if the band is RF2.**
- ⁵ **50 MHz only if the IF mode is Wide.**

When you change the frequency band or the IF mode (SETUP:MAIN → **Band** or **IF Mode**), the frequency and span is reset to the defaults. Set them with SETUP:Freq and Span again.

The frequency and span settings must satisfy the following conditions:

$$\begin{aligned}
 &(\text{Center frequency}) + (\text{Span})/2 \\
 &\leq \text{Upper limit of the frequency setting range (RF mode)} \\
 &\leq 10 \text{ MHz or } 5 \text{ MHz (Baseband mode, depending on the memory mode)}
 \end{aligned}$$

$$\begin{aligned}
 &(\text{Center frequency}) - (\text{Span})/2 \\
 &\geq \text{Lower limit of the frequency setting range (RF mode)} \\
 &\geq 0 \text{ Hz (Baseband mode)}
 \end{aligned}$$

Setting the Frequency with the Marker and Search

You can position the marker in the peak spectrum using the search function. Then, you can set the frequency at the marker position, to the center frequency.

1. Press one of the **VIEW:A** to **D** keys to select the view.
2. Press the **VIEW:SRCH** key.

The marker is positioned at the maximum peak spectrum. Rotating the general purpose knob clockwise searches the peak spectrum rightward and places the marker there, and vice versa.

3. Press the **Mkr->Freq** side key to set the marker frequency position to the center frequency.

Unless you ensure that the span setting, which extends on either side of the new center frequency, is still valid, the frequency you set using this procedure may not take effect. Refer to the following topic, *Buffering the Input Value*.

Buffering the Input Value

The frequency and span settings are stored into the buffer memory temporary. Suppose that the frequency and span have been set to 1.5 GHz and 3 GHz, respectively. If you attempt to change the frequency to 800 MHz, the value displayed in the Freq menu item returns to the initial value, 1.5 GHz. This is because you attempted to input a value that is inhibited as shown in Figure 3-4. The previously input 800 MHz frequency is saved and displayed in the Freq menu item when you select a valid span, such as 200 MHz.

Most settings immediately affect the hardware. The frequency and span settings are written into the buffer. For possible combination of settings, they are then reflected directly to the hardware. If you attempt to input a value that is not allowed, it is buffered but not set in the hardware. If you change another parameter and the combination is permitted, the buffered value takes effect and is reflected to the hardware.

This buffering is made in frequency, span, and frame period settings.

Span and frequency settings must fit within the maximum allowable span setting

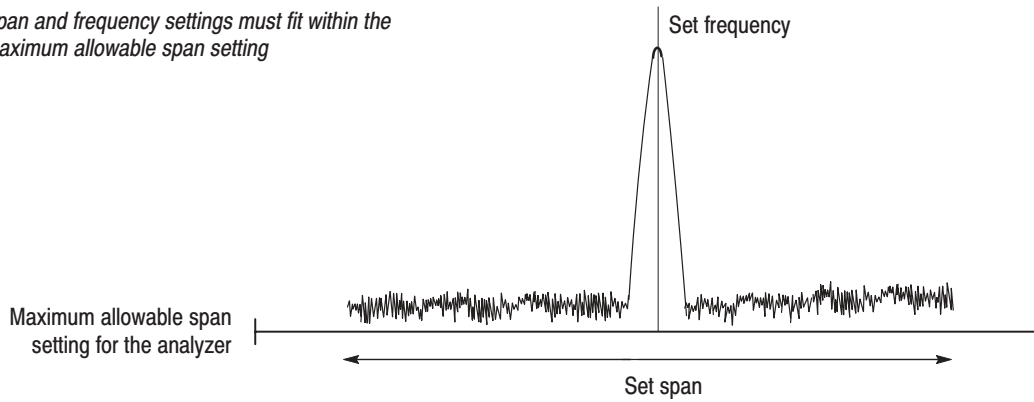

The frequency and span cannot be set as shown in these two illustrations:

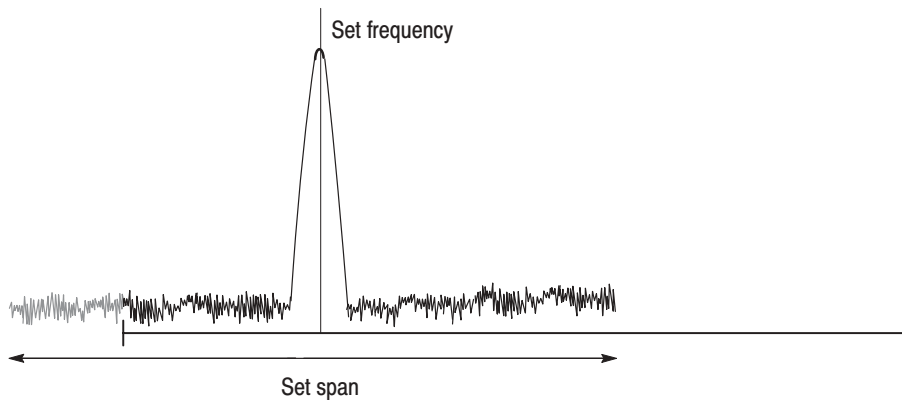
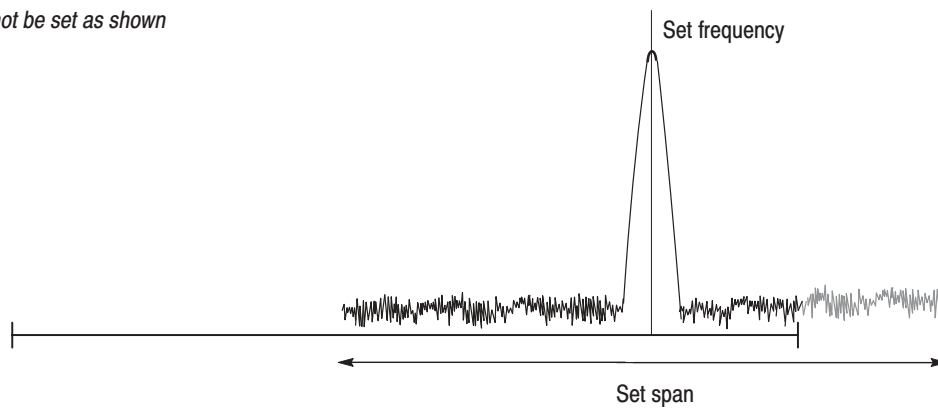

Figure 3-4: Relationship between the frequency and span settings

Reference Level

The reference level setting depends on the input signal level. The reference level defaults to 0 dBm. If the input signal level goes too high or the reference level setting is too low, an input overload may occur.

Setting the Reference Level

Set a reference level with the SETUP keys on the front panel. There are two ways to set it (see Figure 3–5):

- Press **SETUP:MAIN** → **Freq, Span, Ref...** → **Ref** and enter the value using the general purpose knob or keypad.
- Press **SETUP:REF** and enter the value using the general purpose knob or keypad.

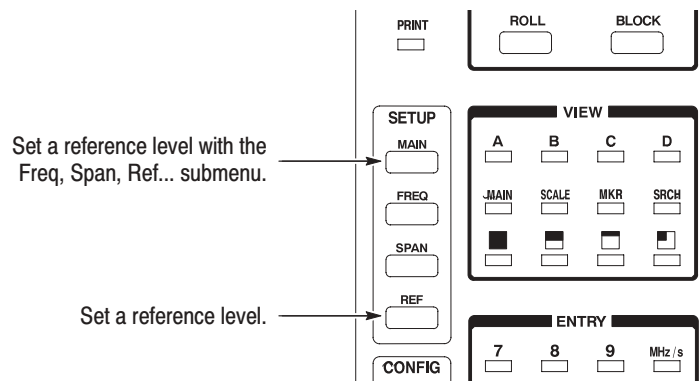

Figure 3–5: SETUP keys for setting reference level

Setting Range The setting range of reference level depends on the input frequency band.

Table 3–5: Reference level setting range

Band	Setting range
Baseband	-30 to +30 dBm (1 dB steps)
RF (WCA330) RF1, 2 (WCA380)	-52 to +30 dBm (1 dB steps)
RF3, 4 (WCA380)	-50 to +30 dBm (1 dB steps)
IQ	-10 to +20 dBm (10 dB steps)

Overload

When an overload occurs, OVERLOAD turns red in the status display area on the screen. Refer to *Status Display* on page 2-7 and Figure 3-6 for overload display indicator.

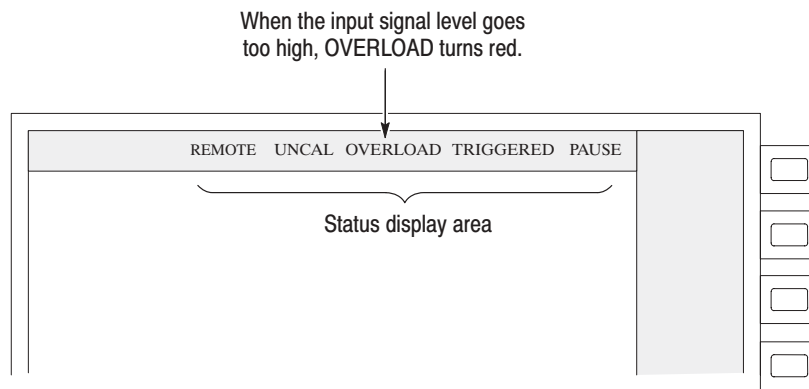

Figure 3-6: Overload indicator

Changing the reference level actually changes the attenuator setting for the internal amplifier. If you continue to operate the analyzer after an overload has occurred, the internal DAC will not work for acquired signals, resulting in a corrupt data display.

The OVERLOAD indicator is updated each time one physical frame is acquired. Because the indicator is for only the current frame, you could miss an overload condition when you have set a long span in the RF mode. In a long span, two or more physical frames are used by one scan; when a high-level signal occurs, OVERLOAD turns red momentarily and then disappears. If you have made settings so that one scan uses one physical frame, a similar phenomenon may result when a single-shot signal occurs.

FFT Parameters

The analyzer is equipped with a hardware fast Fourier (FFT) analyzer. This enables concurrent measurement of time and frequency domain data.

The following three FFT parameters are available:

- FFT type
- FFT point
- FFT window

These parameters can be set by pressing the **SETUP:MAIN** key → **Memory Mode, Input, FFT...**

This section explains each parameter and how to set it.

FFT Type

FFT is usually performed by hardware, however, you can choose to have software perform FFT to improve accuracy. Software uses floating decimal numbers to perform FFT, resulting in better accuracy but a lower speed.

The FFT type depends on memory modes (refer to Table 3–6 below). If the IF mode is set to HiRes or Wide, only software FFT is allowed. On the other hand, if the memory mode is set to Frequency, only hardware FFT is allowed.

FFT Points

You can select either 256 or 1,024 for the number of FFT points. This number is the number of points contained in one physical frame for the time and frequency domains. The smaller the number of points is, the more accurately time-dependent spectrum variations can be observed in the color spectrogram or waterfall view because of a shorten frame period. On the other hand, the larger the number of points is, the better a SN ratio and frequency resolution result.

In the IQ, Wide, Dual and Zoom modes, only 1024 is valid (refer to Table 3–6). When you switch the memory mode to Dual or Zoom with the number of FFT points set to 256, the number of FFT points automatically changes to 1024.

Table 3–6: Input modes and FFT parameters

Input band	IF mode	Memory mode	FFT type ¹	FFT points
Baseband	Normal	Frequency	HW	1024 or 256
		Dual	HW or SW	1024
		Zoom	HW or SW	1024
RF (WCA330) RF1 to 4 (WCA380)	Normal	Scalar	HW	1024 or 256
		Frequency	HW	1024 or 256
		Dual	HW or SW	1024
		Zoom	HW or SW	1024
	HiRes	Scalar	SW	1024 or 256
		Dual	SW	1024
		Zoom	SW	1024
Wide	Zoom	SW	1024	
IQ	Wide	Zoom	SW	1024

¹ HW: Hardware processing. SW: Software processing.

FFT Window

Figure 3–7 outlines how frequency domain data is generated from time domain data.

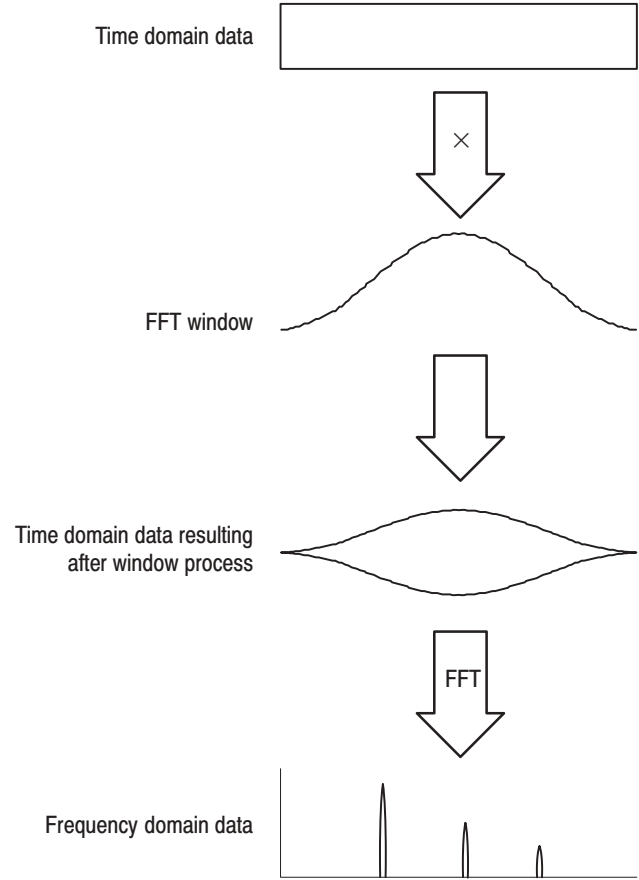

Figure 3–7: Window process of time domain data

The FFT window serves as a band pass filter between time and frequency domain data. The FFT frequency resolution and amplitude accuracy of each frequency component depend on the window shape.

The analyzer supports three FFT windows: Rectangular, Blackman-Harris, and Hamming. See Table 3–7.

Generally, window frequency resolution is inversely proportional to accuracy with which to measure amplitude levels. For ordinary measurement, select the window capable of separating the desired frequency component. Such a window maximizes the accuracy with which to measure amplitude levels and minimizes leakage errors while separating each frequency component.

To select a optimum window, first select the window that maximizes frequency resolution (rectangular window). Then, sequentially switch to windows with less frequency resolution, such as Hamming and Blackman-Harris. Use the last window that still passes the frequency component to be separated. Suitable frequency resolution and amplitude accuracy are obtained by using the window immediately before the one from which the frequency component cannot be separated.

Table 3-7: FFT window and band-pass filter

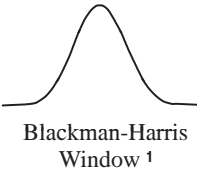
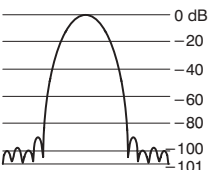
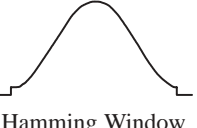
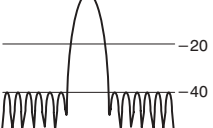
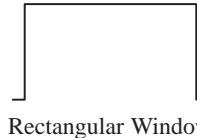
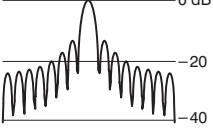
Window type	Band-pass filter	-3 dB bandwidth	Maximum side lobe	Equivalent noise bandwidth
 <p>Blackman-Harris Window ¹</p>		3-sample B-type		
		1.63	-67 dB	1.708
		4-sample B-type		
		1.9	-92 dB	2.0
 <p>Hamming Window</p>		1.3	-43 dB	1.362
 <p>Rectangular Window</p>		0.89	-13 dB	1.0

¹ 3-sample B-type when the FFT type is HW; 4-sample B-type when the FFT type is SW.

For measurement of noise and power, the Blackman-Harris window is valid. For details, refer to *Power Measurement* on page 3-81.

Consider the following characteristics when selecting a window for your purpose:

- Frequency resolution is improved by reducing the width of the main lobe window.
- Accuracy of the amplitude levels of frequency components is improved by reducing side lobe level relative to the main lobe.

Setting FFT Parameters

Uses the following procedure to set FFT parameters:

1. Press the **SETUP:MAIN** key → the **Memory Mode, Input, FFT...** side key.
2. Select the FFT type:
 - a. Press the **FFT Type** side key.
 - b. Turn the rotary knob to select **HW** or **SW**.
3. Select the number of FFT points:
 - a. Press the **FFT Points** side key.
 - b. Turn the rotary knob to select **1024** or **256**.
4. Select the FFT window:
 - a. Press the **FFT Window** side key.
 - b. Turn the rotary knob to select the FFT window.

Acquiring Data

There are two ways to acquire and display data: Roll mode and Block mode. In the Block mode, you can select the block size.

Roll Mode and Block Mode

You can acquire data with the Roll or Block mode (see Figure 3–8).

Roll Mode. In the Roll mode, the captured data is written into the data memory frame by frame while being displayed (one frame has 256 or 1024 data points). The trigger is not available.

Block Mode. In the Block mode, the acquisition stops upon completion one block acquisition. If the trigger has been set, the acquisition stops after the specified number of blocks is acquired. Refer to *Trigger* on page 3–65 for trigger details.

In the Block mode, you can set a time interval between a frame data acquisition and the next acquisition, called “frame period”. Frames can be acquired continuously or overlapped. Refer to *Frame Period and Real-Time* on page 3–25 for detail.

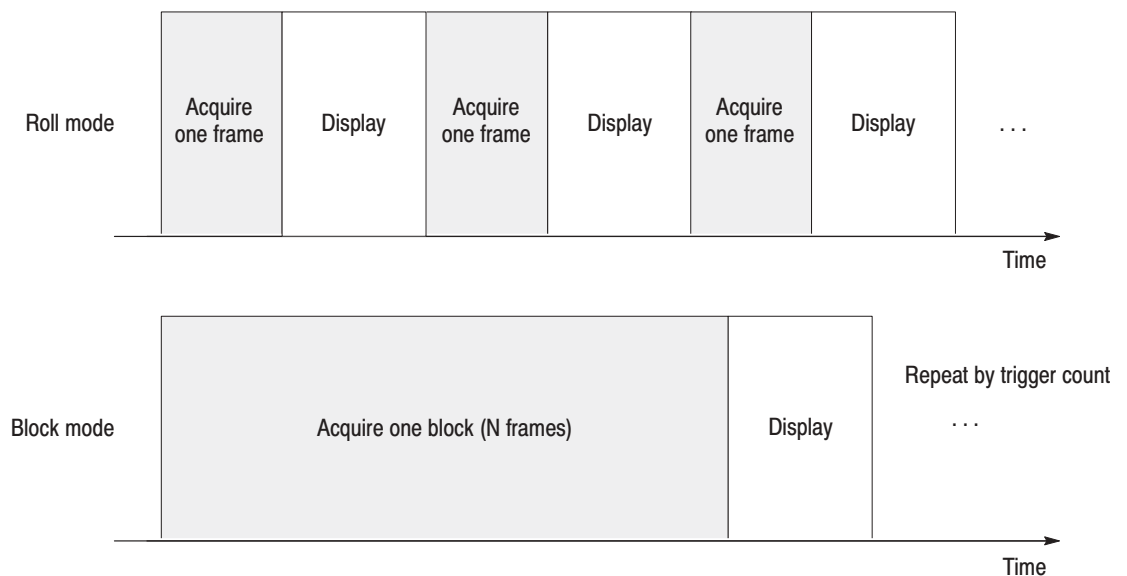

Figure 3–8: Roll mode and Block mode

Setting the Block Size

When you acquire data in the Block mode, set a block size. The block size is the number of frames per block (see Figure 3–9).

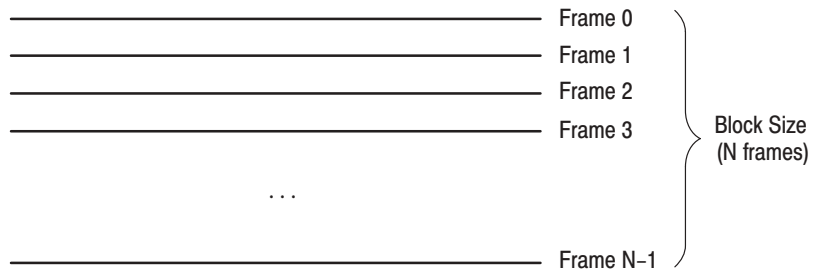

Figure 3–9: Relationship between the block size and frames

Set the block size with the following steps.

1. Press **SETUP:MAIN** → **Block Size**.
2. Turn the general purpose knob to select the block size. The default is 200.

The block size setting range depends on the memory mode and FFT points, as shown in Table 3–8.

Table 3–8: Block size setting range

FFT points	Memory mode	Block size
256	Frequency	1 to 16000 frames
1024	Frequency	1 to 4000 frames
	Dual	1 to 2000 frames
	Zoom	

Starting/Stopping Data Acquisition

Roll Mode. Press the **ROLL** key on the front panel to start the data acquisition in the Roll mode. See Figure 3–10. When you press the **ROLL** key again, the acquisition stops.

NOTE. *The trigger cannot be used in the Roll mode.*

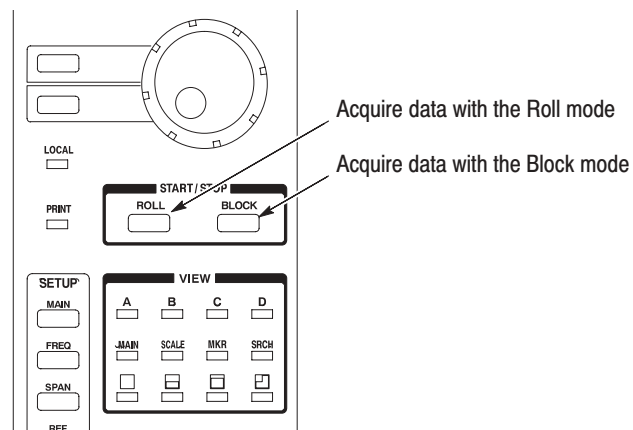

Figure 3–10: ROLL key and BLOCK key

Block Mode. Press the **BLOCK** key on the front panel to start the data acquisition in the Block mode. In the Block mode, the acquisition stops upon completion of one block. If the trigger has been set, the acquisition stops after the specified number of blocks is acquired. Refer to *Trigger* on page 3–65 for trigger details.

If you press the **BLOCK** key again while the data acquisition is in progress, the acquisition stops and only the acquired frame data is displayed. One-block data may not be acquired in this way.

NOTE. *In the RF mode, when you set the span to 10 MHz or larger, the Roll mode operates even if you press the **BLOCK** key. In the Baseband mode, whenever you press the **BLOCK** key, the Block mode operates.*

Frame Period and Real Time

The frame period settings are important when data is acquired in real time in the block mode. This section explains how to set the frame period, and the relationship between the frame period and real time.

NOTE. *In the Zoom mode, the frame period is fixed. You cannot set it.*

Setting a Frame Period

The frame period is the time between acquisition of one frame and the next. See Figure 3–11.

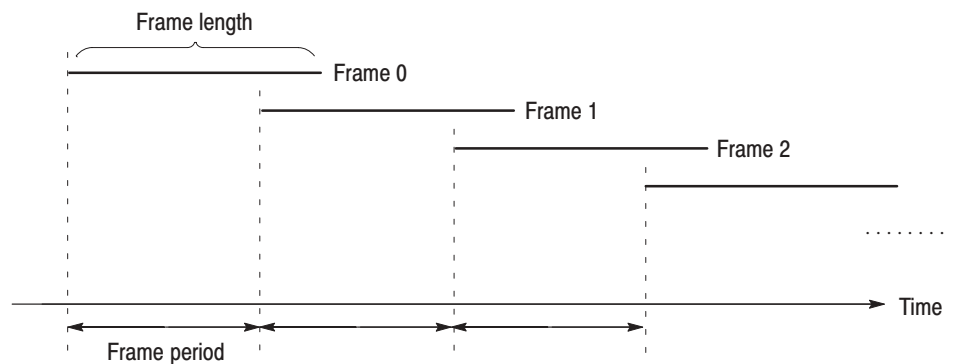

Figure 3–11: Frame period

Use the following procedure to set the frame period:

1. Press the **SETUP:MAIN** key → the **Frame Period** side key.
2. Use the general purpose knob to increase or decrease the value, or enter a numeric value using the **ENTRY** keypad.

Frame Period and Seamless Acquisition

Figure 3–13 on the next page shows the concept of frame periods. In the upper part of this figure, the frame period is so set that frames overlap in the temporal aspect. A shorter frame period allows you to observe time-dependent variations in a spectrum waveform in more detail. If you set the frame period to a value greater than the frame length, there will be a time gap between frames. Acquiring frame data without a time gap is called *Seamless Acquisition*, during which SEAMLESS is displayed in blue in the status display area (Figure 3–12).

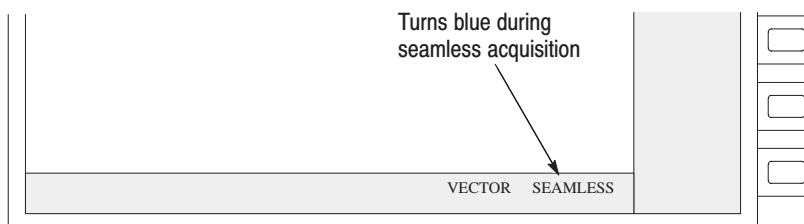

Figure 3–12: Seamless status display

Table 3–9 shows the default minimum frame period. The minimum frame period depends on the number of FFT points and spans. Frame period is valid in the Block mode. In the Roll mode, the frame period is meaningless because data is displayed each time it is written into a frame.

In the Dual mode, the frame period is set to a minimum value by default. In the Zoom mode, the frame period is so set that frames are acquired continuously in the temporal aspect, i.e., the frame period is equal to the frame length. In the Block mode, if the frame period is so set that frames are acquired continuously or frames overlap in the temporal aspect, data is acquired continuously.

Real-Time Acquisition

The seamless acquisition that captures frames with 50 % or more of the frame length overlapped is called *Real-Time Acquisition*. With 50 % or more of the frame length overlapped, FFT processing results in continuous spectrum. With less than 50 % of the frame length overlapped, the result is discontinuous spectrum (see Figure 3–14 on page 3–28).

Real-time acquisition is possible under the following conditions:

Input band . . . Baseband and RF (for WCA330)/RF1 to 4 (for WCA380)
 Span 5 MHz or less

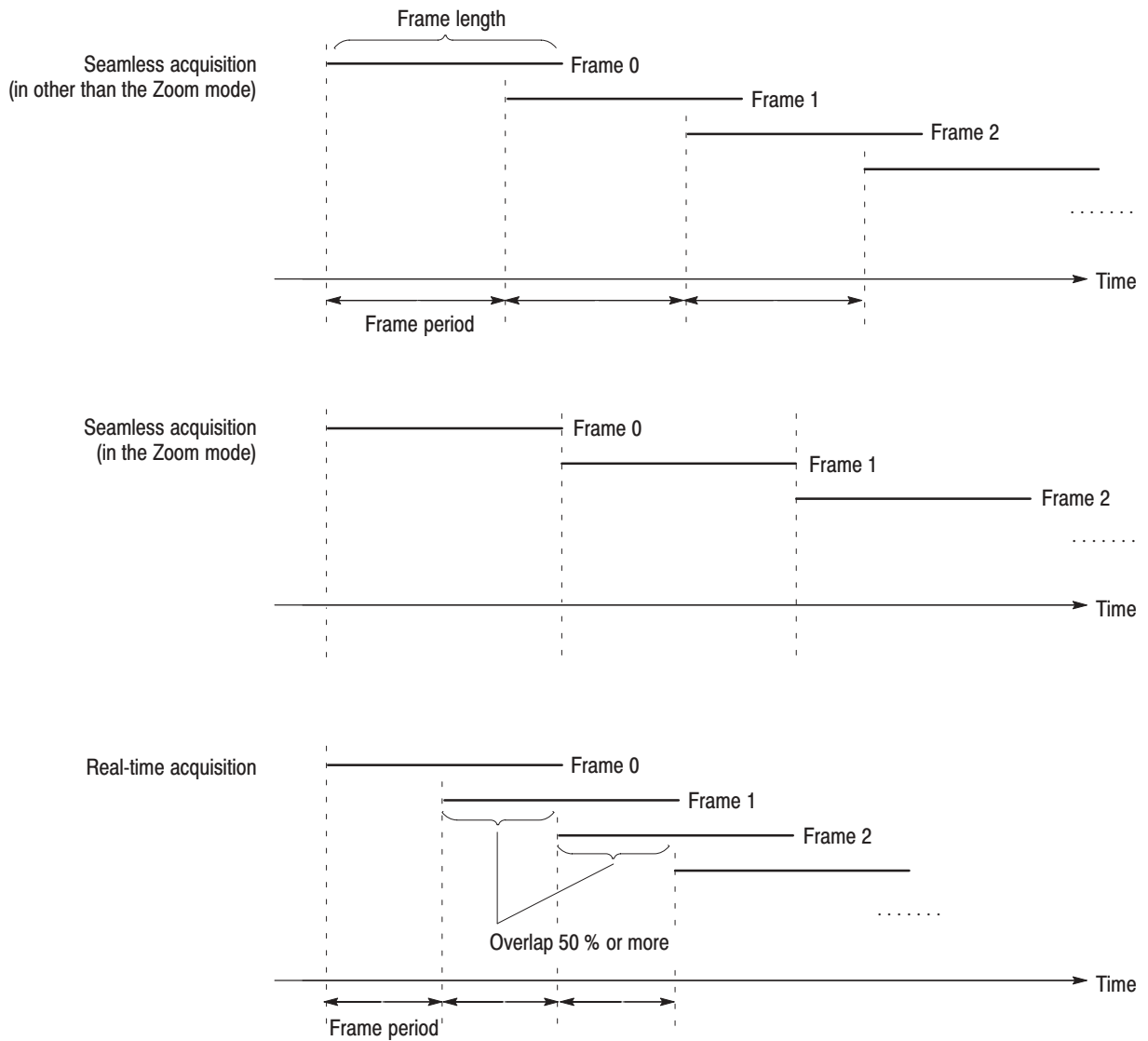

Figure 3-13: Seamless acquisition and real-time acquisition

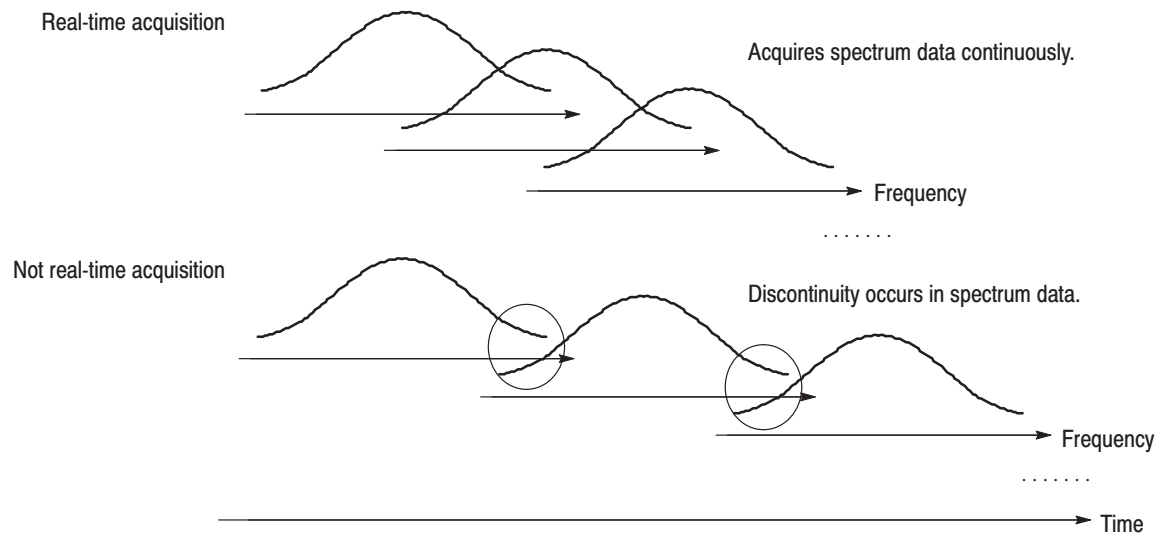

Figure 3-14: Real-time acquisition in the frequency domain

NOTE. If the span is set to 5 MHz or less in the Baseband or RF (WCA330)/RF1 to RF4 (WCA380) mode, data can be acquired in real time.

Table 3-9: Minimum frame period

FFT points	Span	Frame length	Minimum frame period
256	10 MHz and 6 MHz	20 μ s	20 μ s
	5 MHz	40 μ s	
	2 MHz	80 μ s	
	1 MHz	160 μ s	
	500 kHz	320 μ s	
	200 kHz	800 μ s	200 μ s
	100 kHz	1.6 ms	
	50 kHz	3.2 ms	
	20 kHz	8 ms	2 ms
	10 kHz	16 ms	
	5 kHz	32 ms	
	2 kHz	80 ms	20 ms
	1 kHz	160 ms	
	500 Hz	320 ms	
	200 Hz	800 ms	50 ms
100 Hz	1.6 s	100 ms	
1024 IF mode: Normal HiRes	10 MHz	80 μ s	80 μ s
	5 MHz	160 μ s	
	2 MHz	320 μ s	
	1 MHz	640 μ s	
	500 kHz	1.28 ms	
	200 kHz	3.2 ms	200 μ s
	100 kHz	6.4 ms	
	50 kHz	12.8 ms	
	20 kHz	32 ms	2 ms
	10 kHz	64 ms	
	5 kHz	128 ms	
	2 kHz	320 ms	20 ms
	1 kHz	640 ms	
	500 Hz	1.28 s	
	200 Hz	3.2 s	50 ms
100 Hz	6.4 s	100 ms	
1024 IF mode: Wide	30 MHz	25 μ s	25 μ s
	20 MHz	25 μ s	25 μ s
	10 MHz	50 μ s	50 μ s

Displaying Waveform Data

Spectra are displayed in a view on screen. The view is a window where waveform, marker, and measurement results are displayed. Up to eight views can be defined. Up to four windows can be displayed simultaneously.

This section discusses the following topics:

- Setting views
- Setting scales
- Changing display frames
- Relationship among frame, bin, and pixel

Setting Views

Use the VIEW keys on the front panel to set up views (see Figure 3–15).

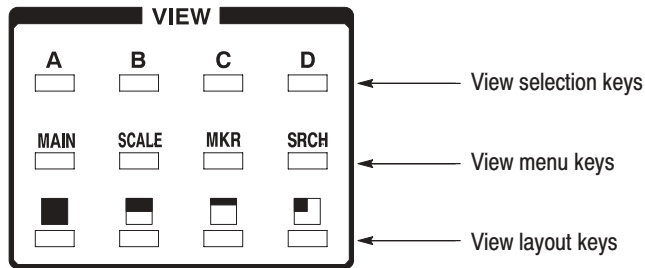

Figure 3–15: View control keys

There are eight views named View A to H. Each view is displayed in the fixed location (see Figure 3–16).

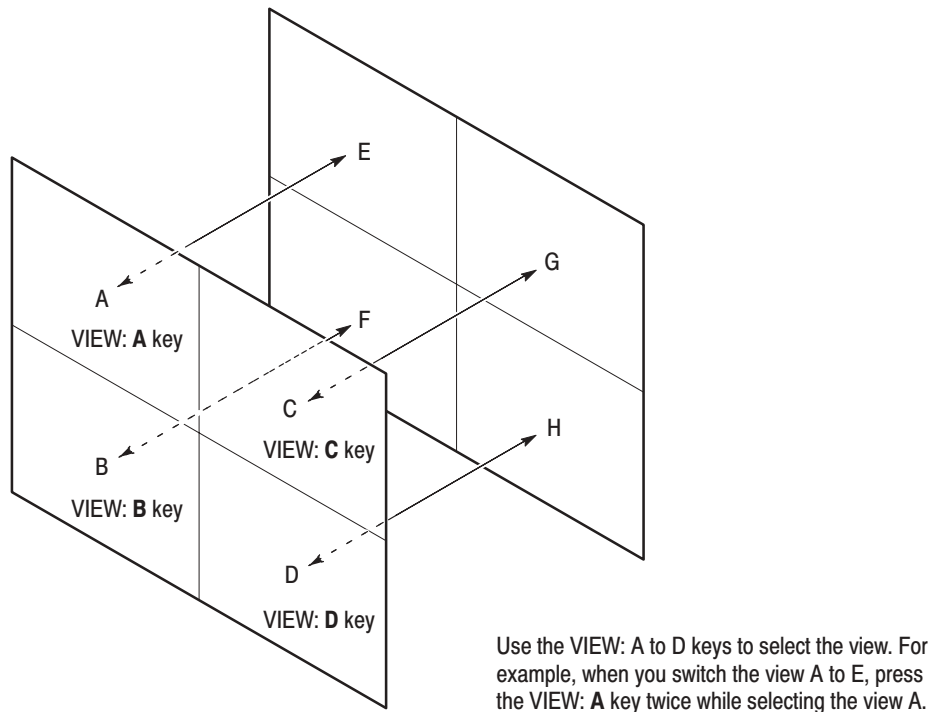

Figure 3–16: Views A to H (2x2 display)

Defining a View

You can display the spectrum in one of the following view types: Waveform, Spectrogram, or Waterfall. To select a view type, use the following steps:

1. Press the **CONFIG:VIEW** key on the front panel. The **CONFIG:VIEW** menu appears.
2. Press one of the **View A to D** side keys. If you want to define View E to H, press one of these side keys after pressing the **More...** key.
3. Use the general purpose knob to select a view.

You can define one to eight views and display up to four views simultaneously.

Switching Views to E to H. You can switch display between View A to D and View E to H respectively (see Figure 4–14). For example, you want to switch display from View A to View E, do the following procedure:

- When View A is currently displayed: Press the **VIEW:A** key twice.
- When View A is not currently displayed: Press the **VIEW:A** key three times.

If you want to switch back from View E to View A, press the **VIEW:A** key twice.

Specifying a Data Source and Display Format

Specify a data source and display format for the defined view using the following steps:

1. Select the defined view. For example, press the **VIEW:A** key.
2. Press the **VIEW:MAIN** key. A view menu appears.
3. Press the **Source** side key and use the general purpose knob to select a data source.
4. Press the **Format** side key and use the general purpose knob to select a display format.

Selection items for the source and format depend on view types. Refer to the view menu descriptions on page 2–63 and below.

NOTE. When you specify None for Source in a view menu, the view is empty.

Specifying the Layout on the Screen

Select one of the view layout keys (see Figure 3–15) to define a view layout.

One-View Display. If you press the  key in the VIEW area, one view is displayed on the screen. Use one of the view selection keys (A, B, C, and D keys) to select the view to be displayed.

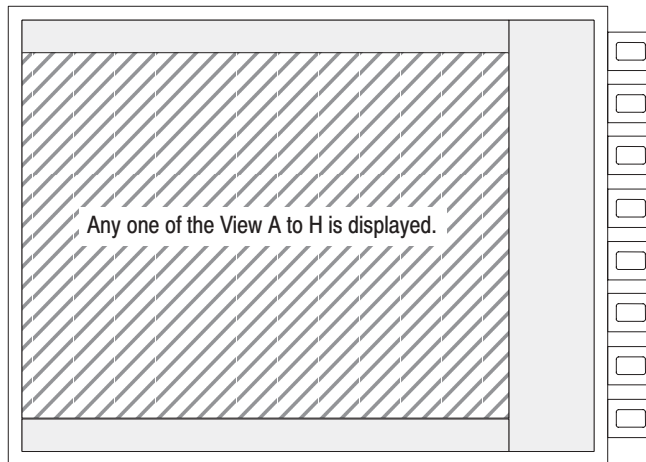



Figure 3-17: One-view display

Two-View Display. If you press the  key in the VIEW area, two views are displayed on the screen. Up to two views can be displayed concurrently in the display area horizontally split into two parts, as shown Figure 3-18.

Use one of the view selection keys (A, B, C, and D keys) to select two views to be displayed. If the selected view is not defined, the display area is empty.

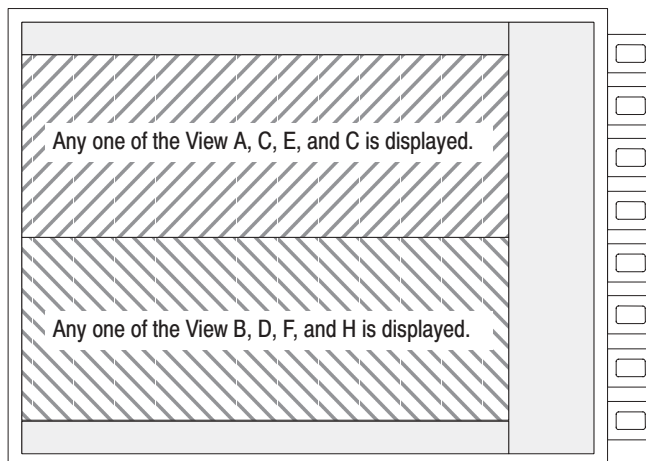



Figure 3-18: Two-view display

Four-View Display. Four views can be displayed at the same time. There are two layouts:

If you press the  key in the VIEW area, 1 × 4 display results. As shown in Figure 3–19, up to four views can be displayed concurrently in the display area horizontally split into four parts.

If you press the  key in the VIEW area, 2 × 2 display results. As shown in Figure 3–20, up to four views can be displayed concurrently in the display area that is horizontally split into two parts and vertically into two parts. If the selected view is not defined, the display area is empty.

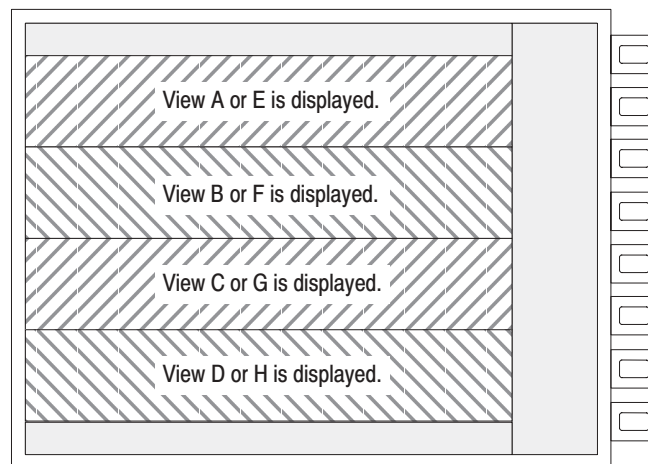

Figure 3–19: Four-view display (1x4 display)

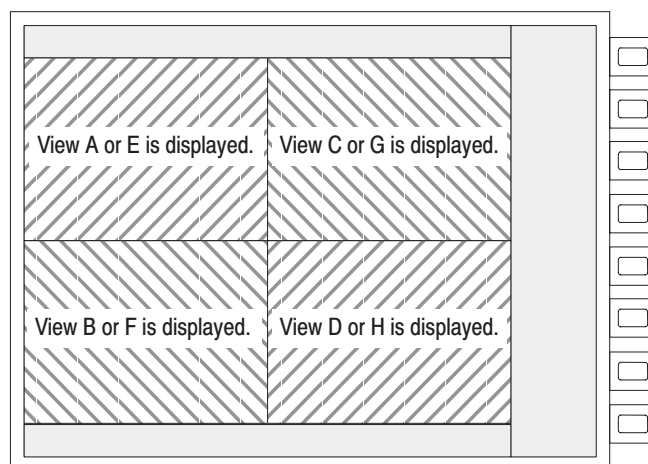

Figure 3–20: Four-view display (2x2 display)

Setting Scales

The horizontal and vertical axes in each view are automatically defined when setting up the SETUP menu items. To change scale settings, use the auto-scale function or set scales manually.

The Polar and SymbolTable views have no scaling function.

Auto-Scale

The analyzer uses the auto-scale function to calculate the optimum scale based on a captured waveform. In the Roll mode, you can use the auto-scale function during data acquisition.

1. Select a view. For example, when you select View A, press the VIEW:A key.
2. Press the VIEW:SCALE key.
3. The **Auto Scale** or **Full Scale** side key is displayed depending on the views. Press either side key. **Auto Scale** sets the vertical scale to show the whole waveform. **Full Scale** resets the vertical scale to the default full-scale.

Changing Scales Manually

You can change the scale for each axis manually:

1. Select a view. For example, when you select View B, press the VIEW:B key.
2. Press the VIEW:SCALE key to display the Scale... submenu. Use the side keys shown in Figure 3–21 to set up the scale for each axis.

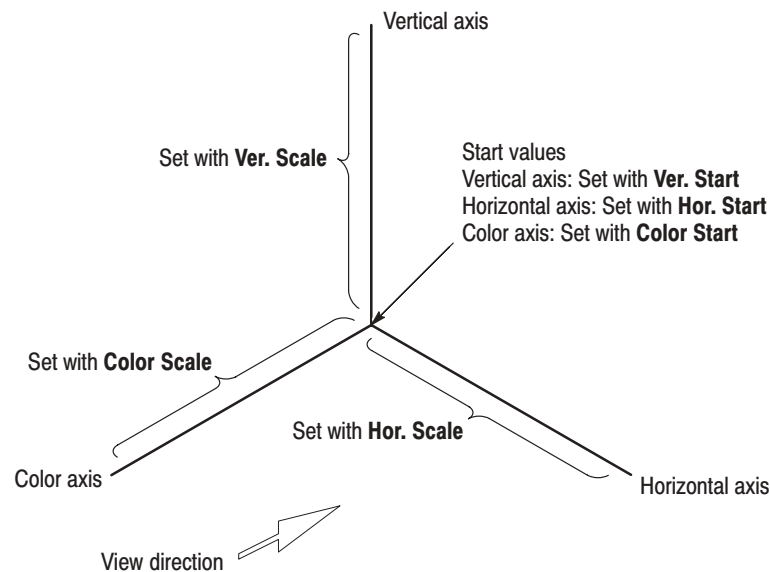

Figure 3–21: Setting scales

Setting Special Scales

For the EyeDiagram, Spectrogram, and Waterfall views, consider the following:

- In the EyeDiagram view, the horizontal axis represents time indicating a symbol length. You must set **Eye Length** in the view menu to a multiple of a symbol length (time).
- In the Spectrogram view, the vertical axis represents frame numbers. The vertical scale is set to the following basic number of frames:

One-view display: 660

Two-view display: 308

Four-view display (1 × 4): 132

Four-view display (2 × 2): 308

You can set **Ver. Scale** in the view menu to a multiple of the basic number of frames. Stop acquiring data before you can change scales. Even if you have changed a scale, once data acquisition begins, the scale is restored to the original setting.

- In the Waterfall view, a spectrum for each frame is compressed vertically. Use **Height** and **Gap** in the view menu to specify the vertical height for a frame on the screen and the frame interval in pixels, respectively. Use **Height Start** and **Height Scale** to specify the start value and the height on the vertical axis, respectively.

NOTE. *In the Waterfall display for the frequency domain, Hor. Start indicating the horizontal axis start value is applied only to the frame #0. The start value for each frame depends on the frame period. For detail on frame period, refer to Frame Period and Real Time on page 3–25.*

Changing Display Frames

The two-dimensional views, such as Waveform and Analog, display data for one frame. By default, the data for frame #0, into which current data is written, is displayed. The three-dimensional views, such as Spectrogram and Waterfall, display several frames simultaneously. If you switch from one display frame to another when several views are displayed on the screen, the frames in the other views are also switched.

This subsection shows how to change display frames and turn the view linking feature on/off.

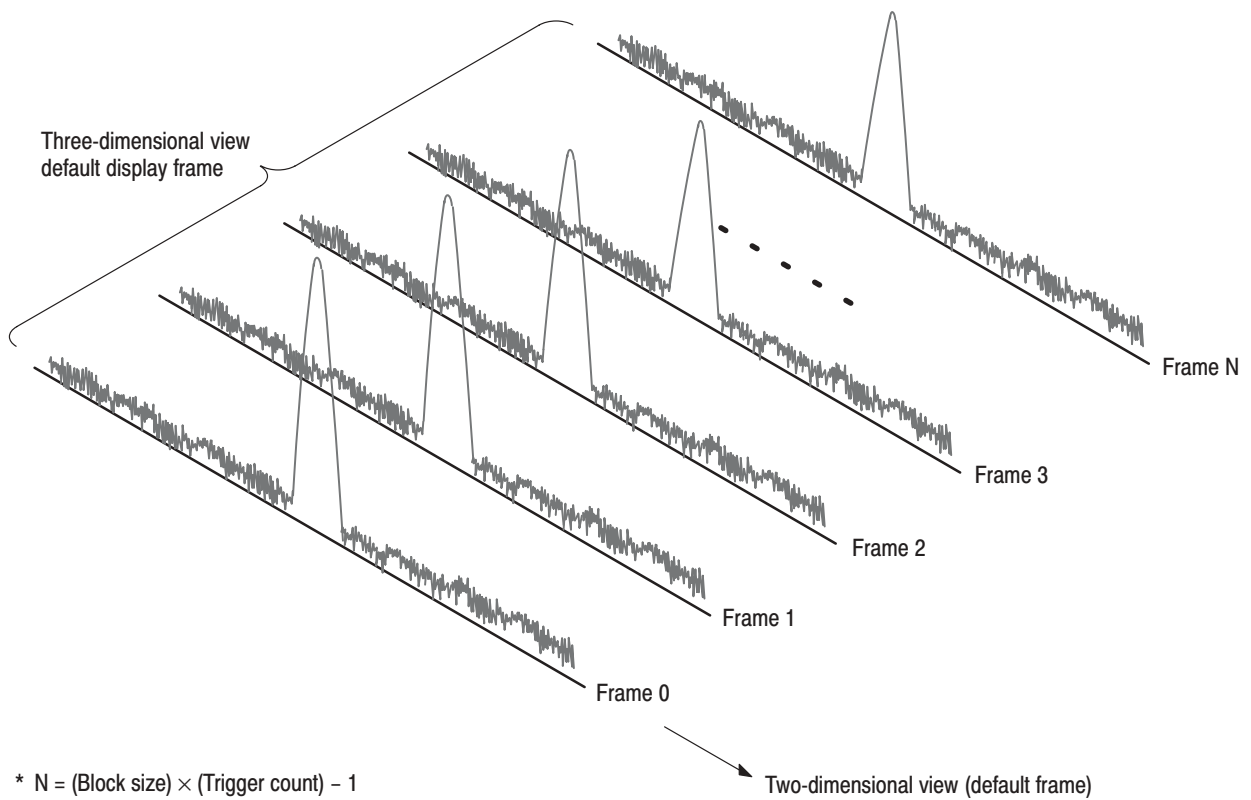

Figure 3-22: Display frames

Changing a Display Frame in a Two-Dimensional View

Use the following procedure to change the frame being displayed:

1. Select a view and display a view menu. Use View C as an example.
 - a. Press the VIEW:C key.
 - b. Press the VIEW:MAIN key.
2. Press the **Frame** side key to enter the desired frame number. The valid frame number depends on the trigger settings as follows:

The trigger count disabled: 0 to (Block count) –1

The trigger count enabled: 0 to (Trigger count) × (Block count) –1

When you use the general purpose knob to change the frame number sequentially, you can observe time-dependent variations in a waveform continuously.

Changing a Marker Frame Position in a Three-Dimensional View

1. Select a three-dimensional view such as Spectrogram or Waterfall, and display a marker menu. Use View B as an example.
 - a. Press the VIEW:B key.
 - b. Press the VIEW:MKR key.
2. Press the **Ver.** side key to change a numeric value.

Use the general purpose knob to observe, in detail, the time-dependent variations in the spectrum.

Linked Views

When several views are displayed on screen, these views are linked together by default. Change of a display frame in a view automatically causes change of display frames in other two-dimensional views and of marker frame positions in other three-dimensional views. Also, change of a marker position in a view causes change of marker positions in other views.

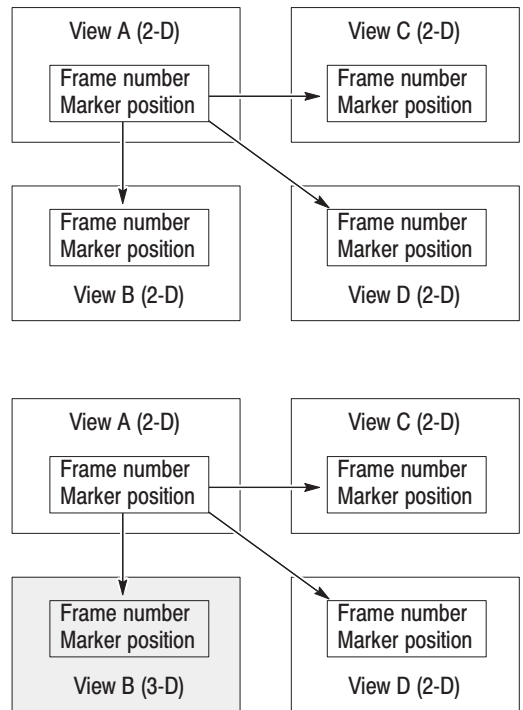

If all of Views A to D are two-dimensional, when the display frame of View A is switched from #0 to #100, all display frames of Views B to D are also switched from #0 to #100.

If View B is three-dimensional and all other views are two-dimensional, when the display frame of View A is switched, the display frames of Views C and D are also switched.

At this time, the frame position of the marker displayed in View B moves together with the display frame of View A.

Figure 3-23: Linked views example

To enable or disable view linking, do the following procedure:

- Press the CONFIG:VIEW key → the **Options...** side key → the **Marker Link** side key and select **On** or **Off**.

On — Views are linked (default).

Off — Views are independent.

Relation among Frame, Bin, and Pixel

One frame contains 256 or 1024 FFT points. A part of data in a frame becomes invalid for the calculation (refer to Table 3–23 on page 3–191). The analyzer discards the invalid data to display only valid data. The valid data is called “bin” (see Figure 3–24 on page 3–42). The number of bins depends on a span and the number of FFT points (refer to Table 3–10).

Table 3–10: The number of bins

Span	FFT points	The number of bins	Supplemental	
≤2 MHz	256	161		
	1024	641		
5 MHz	256	201		
	1024	801		
6 MHz	256	121		
	1024	481		
10 MHz	256	201		Baseband mode only
	1024	801		
10 MHz, 20 MHz	1024	501		IQ and Wide modes
30 MHz	1024	751		

The number of bins is valid for the memory modes other than Scalar, such as Frequency, Dual, and Zoom. It is meaningless in the Scalar mode, because several physical frames are used to display data.

The bandwidth of one bin is calculated as follows. This bandwidth is important for power measurement as described on page 3–81.

$$(\text{Bandwidth of one bin}) = (\text{Set span}) / [(\text{Number of bins}) - 1]$$

Compression of Display Data

Generally, as the number of horizontal pixels on screen is smaller than the number of bins, bin data is reduced to agree with the number of corresponding-pixels when they are displayed (see Figure 3–24).

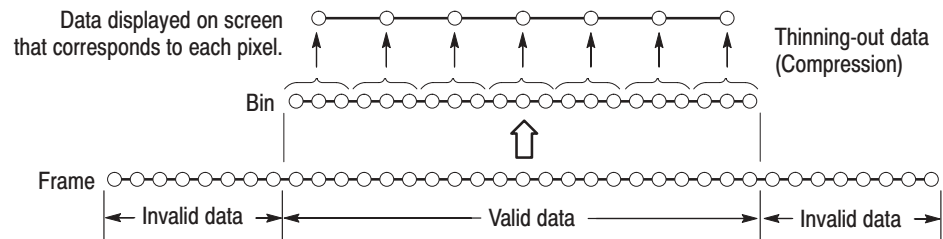

Figure 3–24: Relationship among frame, bin, and pixel

There are four compression types: **Sample**, **Max**, **Min**, and **MinMax** (see Figure 3–25). **MinMax** is commonly used. When the horizontal and vertical axes represent frequency and amplitude respectively (the format is set to FreqAmple), **Max** is used.

In the following views, when you select one of the data register D1 to D8 for the view source, you can select a compression method in the **Compression** menu:

- Waveform view
- Spectrogram view
- Waterfall view
- CDMAWaveform view

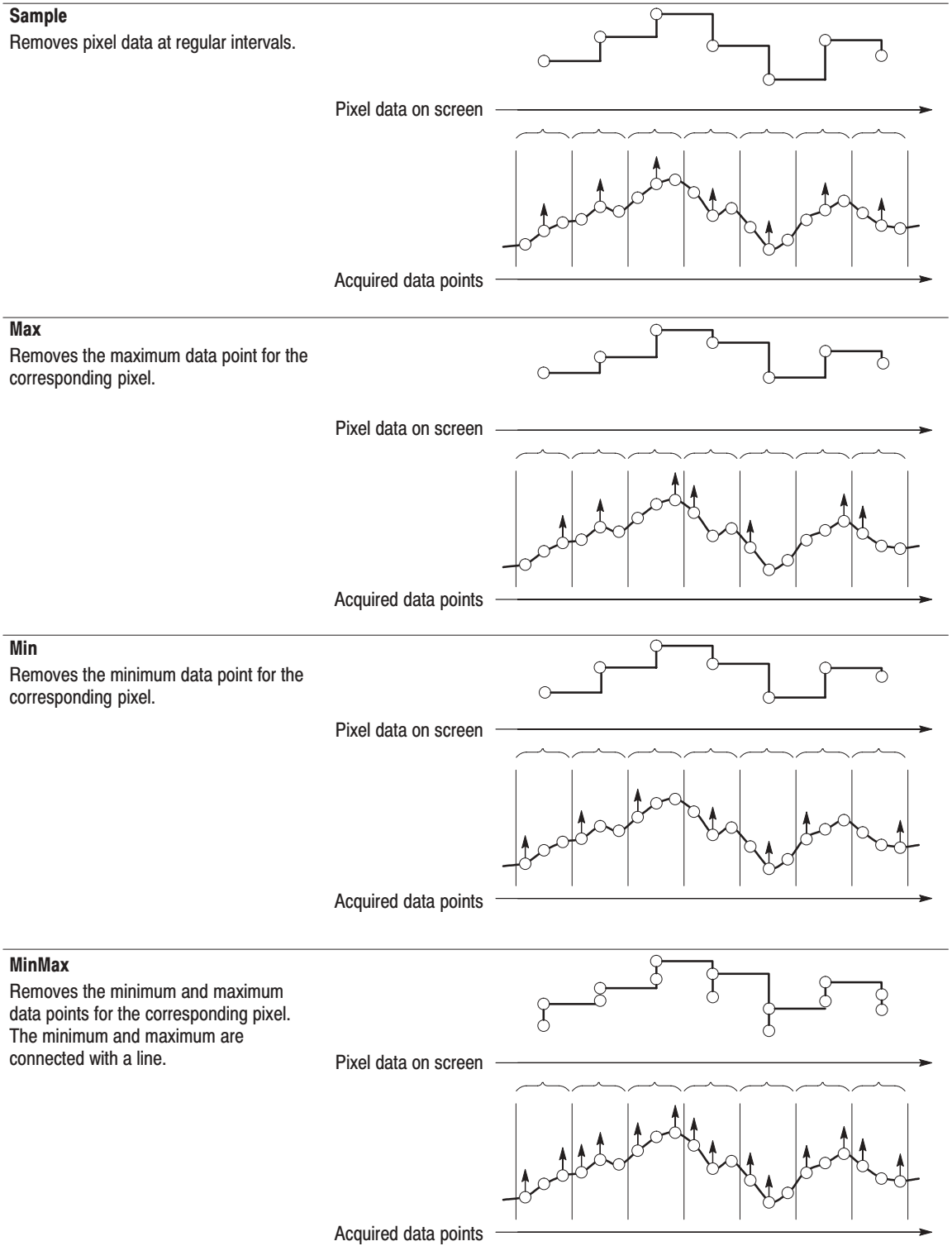

Figure 3-25: Display data compression method

Marker Operations and Peak Search

There are four types of markers: primary marker, delta marker, band power marker, and line marker. The primary and delta markers move along a waveform and indicate the exact value of the data point at the current marker position. To move a marker, use the general purpose knob, keypad, or search functions. This section focuses on the primary and delta marker operations.

You can use the markers to create a trigger mask pattern and to switch a frame to be displayed. For the details, refer to *Creating a Trigger Mask Pattern* on page 3–75 and *Changing Display Frames* on page 3–38.

Type of Marker

There are four types of markers:

- *Primary marker* or *marker* is represented with the symbol \square on screen. It is used to measure absolute values such as the frequency, time, amplitude, and phase at the current marker position. It is also called “absolute marker”.
- *Delta (Δ) marker* is displayed with the symbols \square and \diamond on screen. It is used to measure relative values such as the frequency, time, level, and phase differences between the two markers. The delta marker is also called “relative marker”.
- *Band Power Marker* is represented with two vertical lines. It is used for power measurement. For details, refer to *Band Power Marker Operations* on page 3–90.
- *Line Marker* is shown with a vertical or horizontal line and the value at the marker position for general purpose. The line marker is controlled with the Options... → Display Lines... menu in the views such as Waveform, Analog, FSK, and CodePower.

Moving the Primary Marker

To move the primary marker, use the general purpose knob, the keypad on the front panel, the search functions, or a combination of the knob, keypad and search functions.

1. Select the view by pressing one of the VIEW:**A** to **D** keys.
2. Move the marker in either of the following ways:
 - *General purpose knob:* Press VIEW:**MKR** → **Hor.** Then, turn the general purpose knob to move the marker horizontally. If the **Ver.** menu item is displayed, you can also move the marker vertically by pressing the **Ver.** side key and turning the general purpose knob.
 - *Keypad:* Press VIEW:**MKR** → **Hor.** Then, input the numeric value with the keypad to move the marker horizontally. If the **Ver.** menu item is displayed, you can also move the marker vertically by pressing the **Ver.** side key and inputting the numeric value.

In the Polar and EyeDiagram views, the **Marker** side key is displayed instead of the **Hor.** or **Ver.** side key. In the SymbolTable view, the **Symbol** side key is displayed.

- *Search function:* When you press the VIEW:**SRCH** key, the marker moves to the maximum peak of the waveform. Rotating the knob cw. or ccw. moves the marker to the right or left peak, respectively.

You can use the search menu such as **Peak**, **Max**, and **Min** to move the marker. For detail, refer to each view menu beginning on page 2–63.

3. Read the marker read-out.

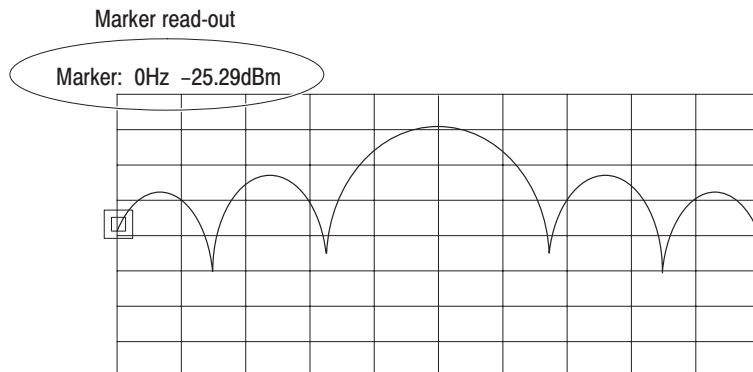

Figure 3–26: Marker read-out

Hints on the Marker Operation

Review the following hints on marker operation:

- You can link the markers between views or operate them separately. For the details, refer to *Linked Views* on page 3–40.
- The search function is disabled along the vertical (frame number) axis in a three-dimensional display such as the spectrogram and waterfall views.
- The search function is not supported for the Polar, EyeDiagram, and SymbolTable views.

Operating the Delta Marker

The delta marker has the on/off and reset controls and marker functions.

Operate the delta marker using the following procedures:

1. Select the view by pressing one of the **VIEW:A** to **D** keys.
2. Press the **VIEW:MKR** key to display the marker menu.
3. Select **On** with the **Delta Marker** side key.

The “Marker” label in the top left corner of the view changes to “Delta”.

Delta: 0Hz 0.0dBm

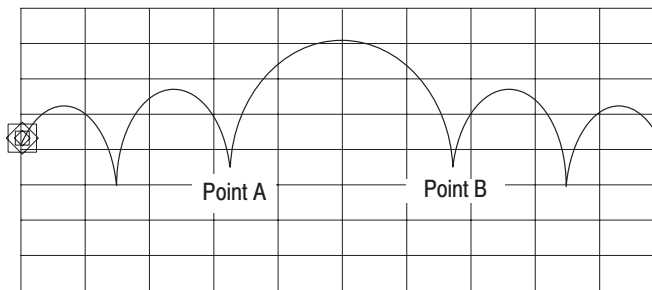

4. Move the marker to the desired position (Point A).

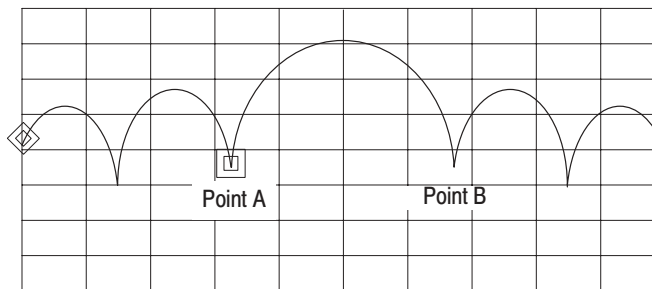

5. Press the **Toggle Delta** side key.
The □ and ◇ markers switch position.

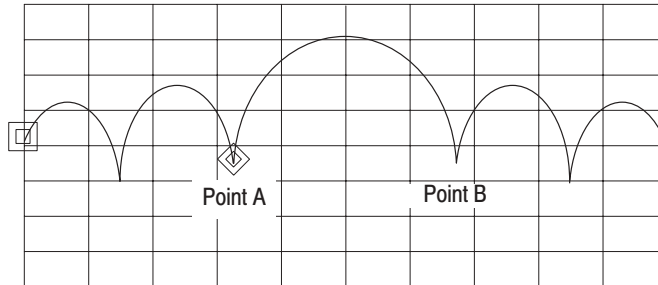

6. Move the □ marker to the desired position (Point B).
The ◇ marker remains.

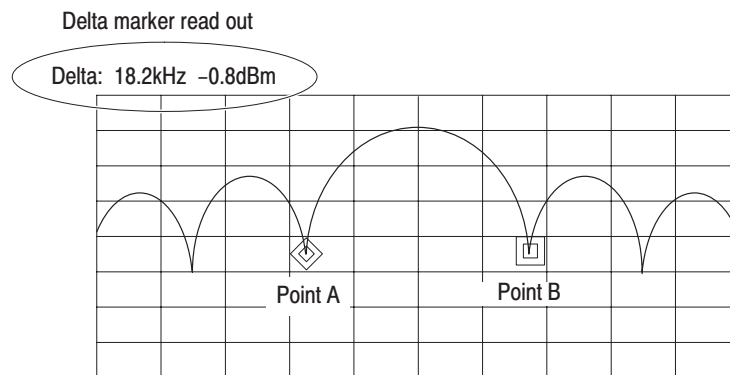

The ◇ marker is positioned at Point A, and the □ marker at Point B.

7. Read the marker read-out.

Zoom

Zoom enables you to observe details of a spectrum around a selected frequency by enlarging the acquired spectrum waveform in the specified span.

This section discusses the following topics:

- Zoom process
- Zoom range
- Zoom operation

Zoom Process

The zooming function regenerates the frequency domain data, with a new frequency, from the time domain data acquired in the Zoom mode. For example, suppose that a signal was observed with a center frequency of 5 MHz and a span of 1 MHz. The Zoom mode re-analyzes exactly the same signal with a center frequency of 2.5 MHz and a span of 100 kHz, and displays the result on screen. You can set the span to 1/1,000 to 1/2 with high precision without causing amplitude or phase distortion. This differs from enlargement by simple division scale or interpolation. In addition, while changing the center frequency and span settings, you can repeat zooming the data acquired once. During the zoom process, the original data in the frequency domain is saved in the CPU memory so it can be re-displayed at any time.

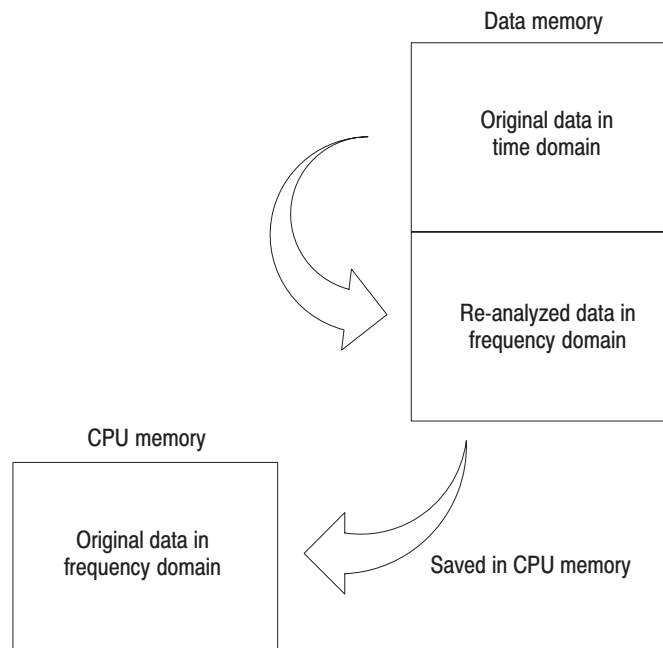

Figure 3-27: Zoom process

Zoom Range

Available Data All data available for display in the Waveform, Analog, FSK, Waterfall, or Spectrogram views is available for zoom. When zoom runs, the waveform enlarges by the specified factor along the time and frequency axes.

Expansion Factor The zoom range depends on the block size (number of frames) and the span settings. If you press the **BLOCK** key during data acquisition, the resulting written data does not reach the set block size. In this case, the block size depends on the number of written frames and the span. The magnification is as follows:

Table 3-11: Zoom range

Mode	Span	Expansion factor
RF, Baseband	5 MHz	2 to the number of frames in 2-5-10 step
	Other than 5 MHz	2 to the number of frames in 2-4-10 step
IQ, Wide	10 MHz, 20 MHz, 30 MHz	2 to the number of frames in 2-5-10 step

When running zoom, one physical frame is regenerated using the physical frame in the time domain for the magnification. Therefore, the number of frames that can be displayed in the Spectrogram and Waveform views is

$$(\text{The number of acquired frames}) / (\text{Expansion factor}) - 1.$$

NOTE. For a three-dimensional view, one frame of those resulting from zoom will not contain the data available for display, so the number of frames available for display will decrease by one.

Zoom Operation

To perform zooming, use the following procedure:

1. Set the analyzer to the Zoom mode. There are two ways:
 - a. Use the *CONFIG* menu (basic configuration pattern):
Press **CONFIG:MODE** → **Zoom**.
 - b. Use the *SETUP* menu:
Press **SETUP:MAIN** → **Memory Mode, Input, FFT...** → **Memory Mode** and select **Zoom**.
2. Set the center frequency, span, reference level, and other parameters as necessary.
3. Set the unzoomed view. For example, if you display an unzoomed spectrum in View A with the Waveform view, do the following step:
 - a. Press **CONFIG:VIEW** → **View A** and select **Waveform**.
4. Set the zoomed view. For example, if you display the zoomed spectrum in View C with the Waveform view, use the following steps:
 - a. Press **CONFIG:VIEW** → **View C** and select **Waveform**.
 - b. Press **VIEW:C** → **VIEW:MAIN** → **Source** and select **Zoom**.
5. Press the **BLOCK** key to start the data acquisition.

After one block of data has been captured, the acquisition is completed and View A displays the spectrum.
6. Run the zoom.
 - a. Press **SETUP:MAIN** → **Zoom...**
 - b. Press the **FFT Type** side key to select the FFT type.
For the FFT type, refer to page 3–16.
 - c. Press the **FFT Window** side key to select the FFT window.
For the FFT window, refer to page 3–17.
 - d. Press the **Frequency** side key to input the center frequency after zooming.
 - e. Select the **Mag** side key to select the expansion factor.
The span equals (Unzoomed span / expansion factor).
 - f. Zoom by pressing the **Execute** side key.

Now, the enlarged spectrum is displayed in View C. If necessary, repeat step 6 while changing the center frequency and expansion factor.

In Figure 3–28, View A displays the original spectrum of the signal acquired in the Zoom mode. View C displays the spectrum resulting from the zoom process. In this example, the signal acquired with a center frequency of 800 MHz and a span of 100 kHz enlarges by a factor of 100 around a center frequency of about 800 MHz.

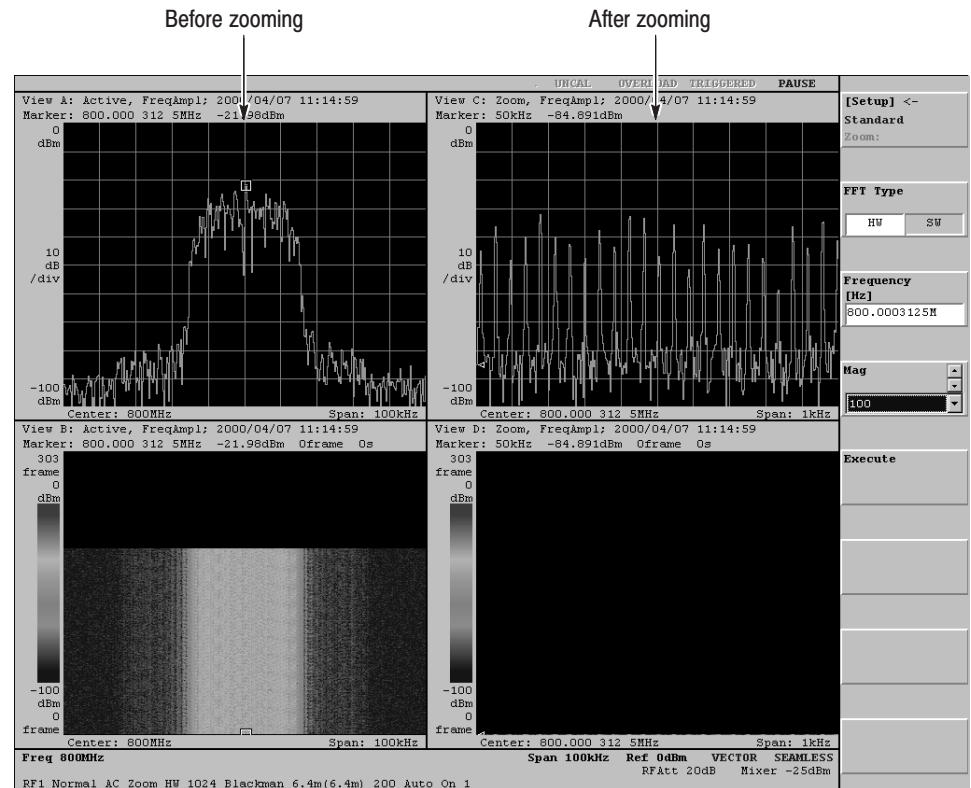

Figure 3–28: Spectra before and after zooming

Setting the Center Frequency With the Search Function

You can position a marker at the peak spectrum using the search function, and then set the frequency at the marker position to the center frequency for zoom.

1. Using the VIEW:**A** to **D** keys, select the view in which you operate the marker.
2. Press the VIEW:**SRCH** key.

The marker is positioned at the maximum signal peak. Rotating the general purpose knob clockwise initiates a search for the next peak to the right and positions the marker there, and vice versa.

The frequency at the marker position is immediately set to the zoom center frequency (SETUP:**Zoom...**→ **Frequency**). If necessary, change the center frequency by fine-tuning the marker position.

3. Press the **Execute** side key to run the zoom with the new center frequency.



Average and Peak Hold

The averaging technique is generally used to enhance the signal-to-noise ratio. This section describes the averaging process and provides operating examples. The average function also includes the peak hold.

Averaging Process

There are two ways of averaging.

- Using the average in the Waveform view
- Using the average in the Utility menu

Using the Average in the Waveform View

In the averaging of the Waveform view, when you select **Average...→ Average → On**, the analyzer performs averaging while acquiring the data. (In the Block mode, it displays raw data without averaging.) When you select **Average...→ Execute**, the analyzer averages the data that has been acquired once in the Roll or Block mode. See Figure 3–29.

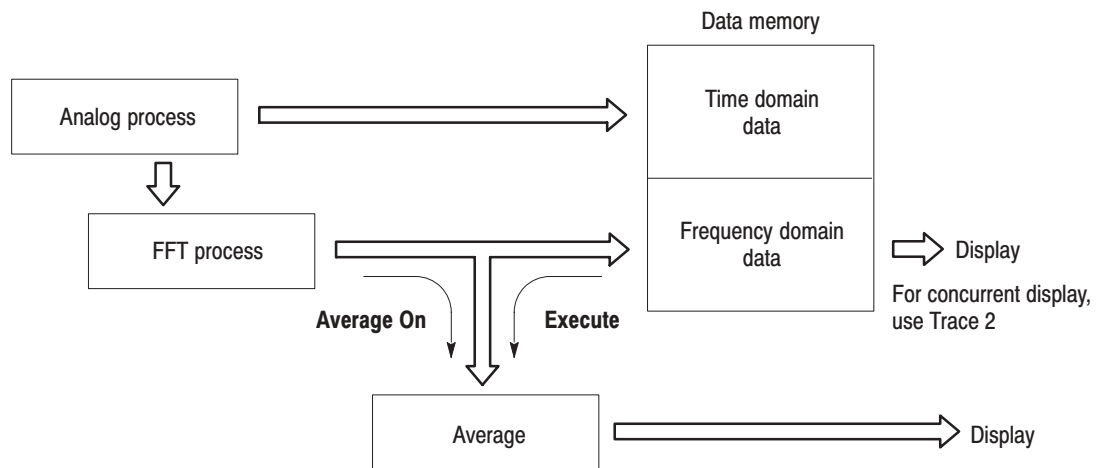

Figure 3–29: Averaging process in the view

Using the Average in the Utility Menu

The average function in the CONFIG:UTILITY (Util C) menu can process data when waveform acquisition is at a stop. The data to be processed must be in a file or in the data memory.

The analyzer has eight data registers that store the acquisition data (see Figure 3–30). You can use data registers D1 to D8 to store the averaging results.

The average data written in a data register can be displayed separately through a view or displayed together with the contents of the original data memory or file before averaging.

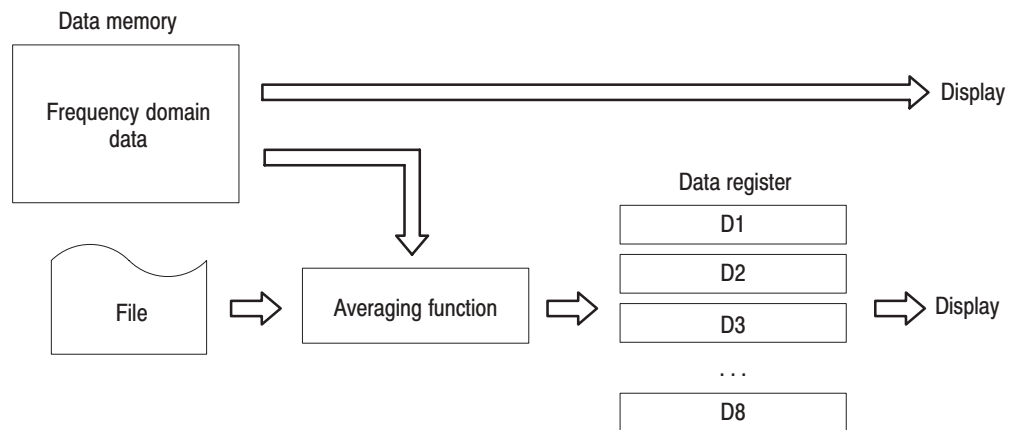

Figure 3–30: Process of the utility average

Averaging Mode

The analyzer has three averaging modes.

Peak Hold. Displays only the maximum value.

$$\begin{aligned} X(p)_n &= x(p)_n && \text{for : } n = 1 \\ X(p)_n &= \max(X(p)_{n-1}, x(p)_n) && \text{for : } n \geq 2 \end{aligned}$$

RMS. Root-mean-square

$$\begin{aligned} X(p)_n &= x(p)_n && \text{for : } n = 1 \\ X(p)_n &= \frac{(n-1) \times X(p)_{n-1} + x(p)_n}{n} && \text{for : } 2 \leq n \leq \text{NumAverage} \\ X(p)_n &= x(p)_{\text{NumAverage}} && \text{for : } n > \text{NumAverage} \end{aligned}$$

The view average function processes n frames. You can set the number of frames for averaging with the Num Averages menu item. The utility average function processes the frames specified with the Begin Frame, End Frame, or All Frames menu item.

RMSExpo. Exponential root-mean-square

$$\begin{aligned} X(p)_n &= x(p)_n && \text{for : } n = 1 \\ X(p)_n &= \frac{(n-1) \times X(p)_{n-1} + x(p)_n}{n} && \text{for : } 2 \leq n \leq \text{NumAverage} \\ X(p)_n &= \frac{(\text{NumAverage} - 1) \times X(p)_{n-1} + x(p)_n}{\text{NumAverage}} && \text{for : } n > \text{NumAverage} \end{aligned}$$

Where

$X(p)_n$: Display data for the nth frame
 $x(p)_n$: Active data for the nth frame
 P : Frame point
 NumAverage : Weighting factor

Continuous averaging weights older sweeps so that they have a progressively smaller effect on the average. The utility average function does not support the RMSExpo mode.

Operating Example of the View Average Function

In this example, View A simultaneously displays an ordinary spectrum and its averaged waveform.

1. Set the view.
 - a. Press **CONFIG:VIEW** → **View A** and select **Waveform**.
 - b. Press **VIEW:A** → **VIEW:MAIN** → **Average...**
 - c. With the **Average** side key, select **On**.
 - d. With the **Average Type** side key, select the averaging mode.
 - e. With the **Num Averages** side key, set the number of averaging.
 - f. Press the side key **[View A]<** → **Options...** → **Trace2...** → **Source** and select **Active**.
2. Press the **ROLL** key to acquire the signal.

The ordinary spectrum and its averaged data are displayed simultaneously in the View A (see Figure 3–31).

If you press the **Reset** side key, the averaging restarts.

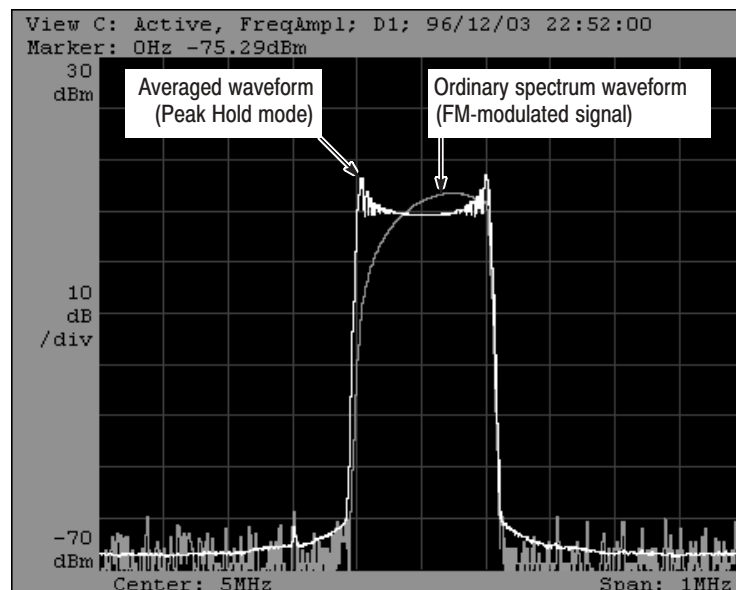

Figure 3–31: Simultaneous display of a spectrum and its averaged waveform (Example)

Averaging the Data Already in Memory

Data that was previously acquired in the Roll or Block mode can be averaged using the following procedure. View A is used as the Waveform view.

1. Set the average parameters:
 - a. Press **VIEW:A** → **VIEW:MAIN** → **Average....**
 - b. With the **Average Type** side key, select the averaging mode.
 - c. With the **Num Averages** side key, set the number of averaging.
 - d. With the **Begin Frame** and **End Frame** side keys or **Mkr** → **Frame** side key, specify the frame range for averaging.
2. Press the **Execute** side key to run averaging.

Operating Example of the Utility Average Function

Suppose that the data memory already contains the data acquired in the Roll or Block mode. If you use the Roll mode, stop the data acquisition before executing the process.

1. Set the average parameters in the utility menu:

- a. Press **CONFIG:UTILITY** → **Util C [Average]** → **Source** and select **Active**.

The contents of the data memory are processed in this case. To process the contents of a file, select either **File (*.IQ)** or **File (*.AP)**.

- b. Input the frame numbers in **Begin Frame** and **End Frame** to define the frame range to be processed.

If you press the **All Frame** side key, 0 and (total number of frames – 1) are set in **Begin Frame** and **End Frame**, respectively. If you press the **Mkr→Frame** side key, the number of the frame in the marker position is set in **End Frame**.

- c. Press the **Destination** side key to select one of the D1 to D8 data registers for the destination.
- d. Press the **RMS** (root-mean-square) side key or **PeakHold** (peak hold) side key to execute the process.

When you press the **RMS** or **PeakHold** side key, the side key turns white, indicating that the process is in execution. Wait until the key returns to the initial color (gray), indicating that the process is complete.

2. Display the contents of the data register.

For example, use View A as the Waveform view.

- a. Press **CONFIG:VIEW** → **View A** and select **Waveform**.
- b. Press **VIEW:A** → **VIEW:MAIN** → **Source** and select the data register you set in step 1c.

Now, the averaging result is displayed.

Trigger

The user can specify various triggering parameters.

NOTE. *Trigger is valid for the Block mode. It is not used in the Roll mode.*

These are the trigger parameters:

- Mode: Selects how to trigger.
- Count: Specifies how many times a block data is acquired.
- Domain: Selects either the time or frequency domain.
- Source: Selects a trigger signal source.
- Slope: Selects the rising or falling edge of a trigger signal.
- Position: Specifies a trigger position.

This section describes the above topics in detail.

Setting a Trigger

Use the Trigger... menu invoked by **SETUP:MAIN** → **Trigger** to make trigger-related settings.

Trigger Mode

Trigger modes specify how to acquire and display data before or after trigger occurs.

Setting.

- Press **SETUP:MAIN** → **Trigger...** → **Mode** to select a trigger mode.

There are several trigger modes:

Auto — When you press the **BLOCK** key, the analyzer acquires and displays one block of data. When you press the **BLOCK** key again, it stops acquisition (see Figure 4–31). Data is written into the same memory block repeatedly.

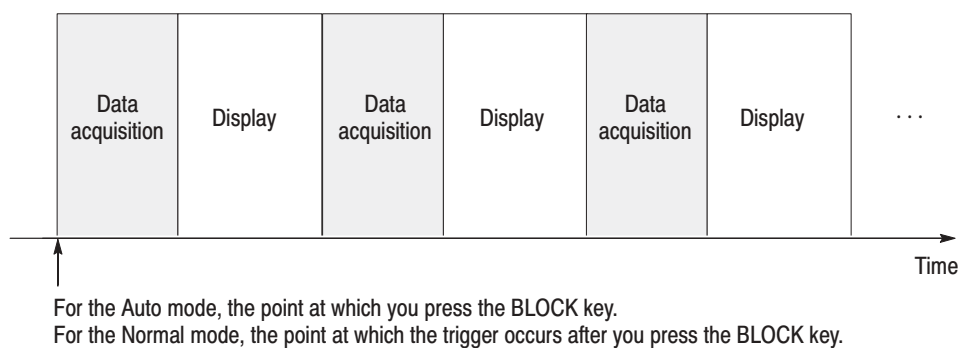

Figure 3-32: Acquiring and displaying data in the Auto and Normal modes

When you press the **BLOCK** key with Trigger Count set to On, the analyzer repeats data acquisition and display the number of times specified by Times.

Normal — When you press the **BLOCK** key, the analyzer waits for trigger generation and acquires the specified number of frames after the trigger occurs.

With Trigger Count set to On, the analyzer repeats data acquisition the number of times specified by Times.

When you create a trigger mask pattern on the Waveform view, if you press the Draw Max, Draw Line, Draw Min or Draw Horizontal side key in the Edit... submenu, the trigger mode is automatically set to Normal.

Delayed — Same as Normal except that the analyzer completes data acquisition at the specified time after trigger generation.

The delayed time is set with **Trigger...→ Delayed**.

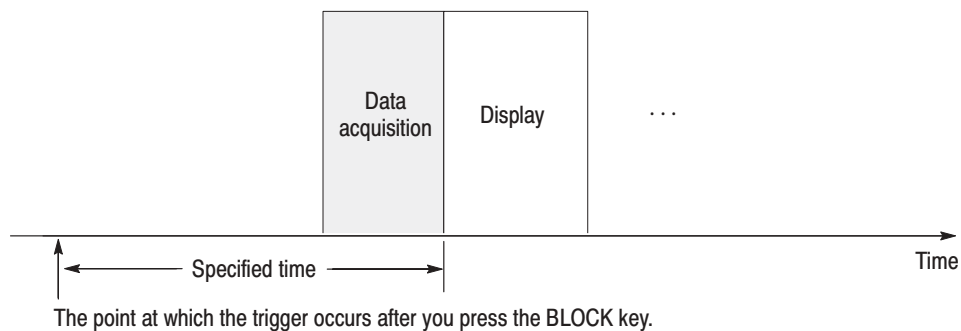

Figure 3-33: Delayed trigger

Timeout — The analyzer acquires data when no trigger is generated for a certain period. If trigger events occur repeatedly for a certain period, analyzer does not acquire data and waits. This setting is valid when specifying an internal trigger source.

The timeout value is set with **Trigger...→ Timeout**.

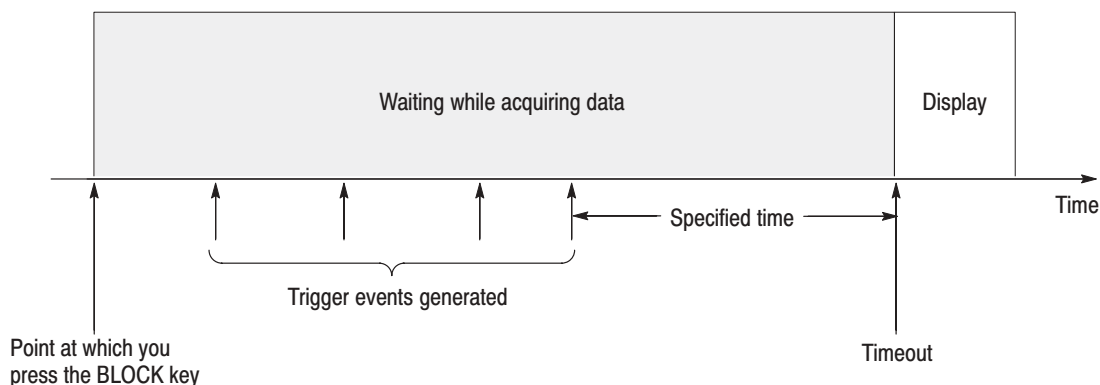

Figure 3-34: Timeout trigger

Interval — The analyzer repeats data acquisition and display at a regular interval.

The interval value is set with **Trigger... → Interval**.

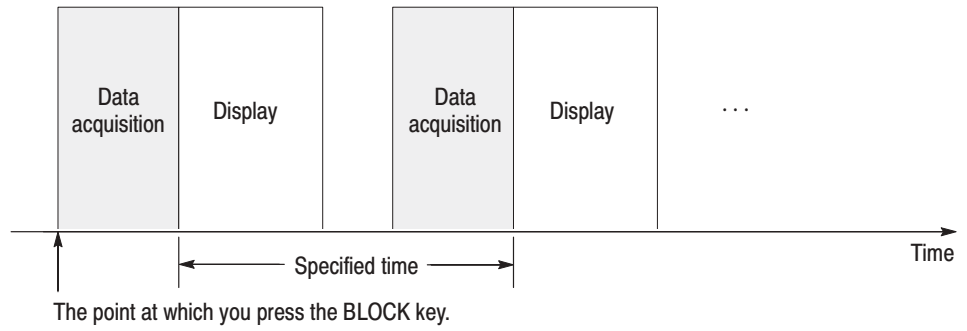

Figure 3-35: Interval trigger

Quick — Same as Normal except that the analyzer acquires all the blocks and then displays them.

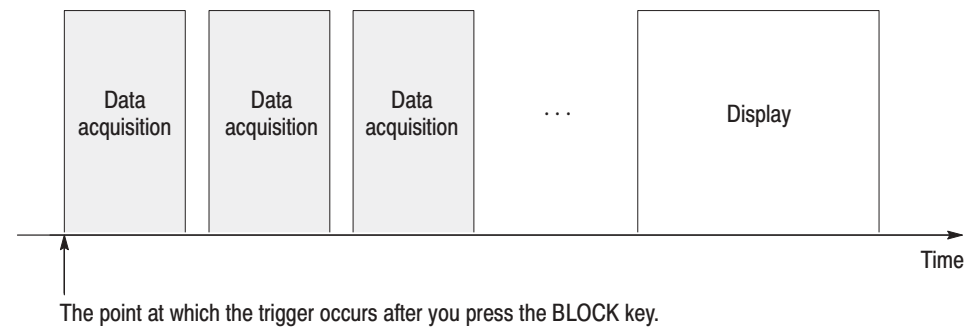

Figure 3-36: Quick trigger

Quick Interval — Same as Interval except that the analyzer acquires all the blocks and then displays them.

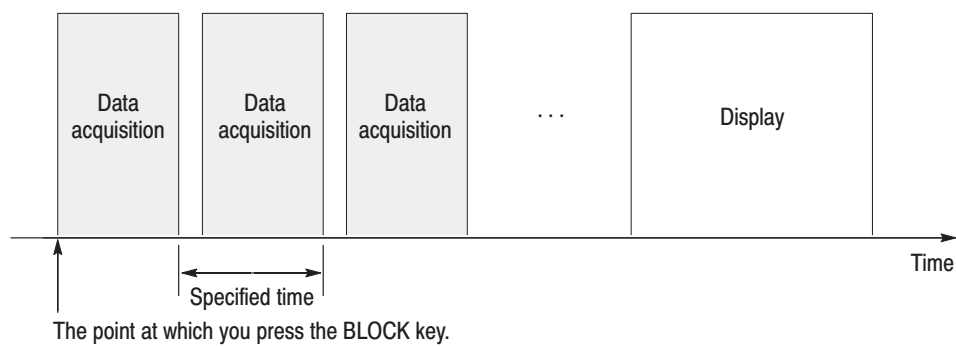

Figure 3-37: Quick Interval trigger

Never — Press the **BLOCK** key to start or stop acquisition of one block of data manually. Other trigger settings are not effective.

Trigger Count

The trigger count specifies the number of times data is acquired. Depending on the trigger mode, data acquisition is performed in the following two cases:

- When you press the **BLOCK** key, the analyzer acquires data the number of specified times and terminates the process regardless of trigger conditions.
- When you press the **BLOCK** key, the analyzer acquires data the number of specified times after trigger generation and terminates the process.

Setting.

1. Press **SETUP:MAIN** → **Trigger...** → **Count** and select **On** (enabled) or **Off** (disabled).
2. When you turn **Count** on, press the **Times** side key to enter the value.

The maximum trigger count depends on the number of FFT points and memory modes (refer to Table 3–12).

Table 3–12: Maximum trigger count

FFT points	Memory mode	Maximum trigger count (fraction part rounded down)
256	Frequency	16,000 ÷ (Block size setting)
1024	Frequency	4,000 ÷ (Block size setting)
	Dual	2,000 ÷ (Block size setting)
	Zoom	

If you set the trigger count to 1 or more, block-to-block gaps are displayed in thin black stripes. (They are shown in white in this figure.)

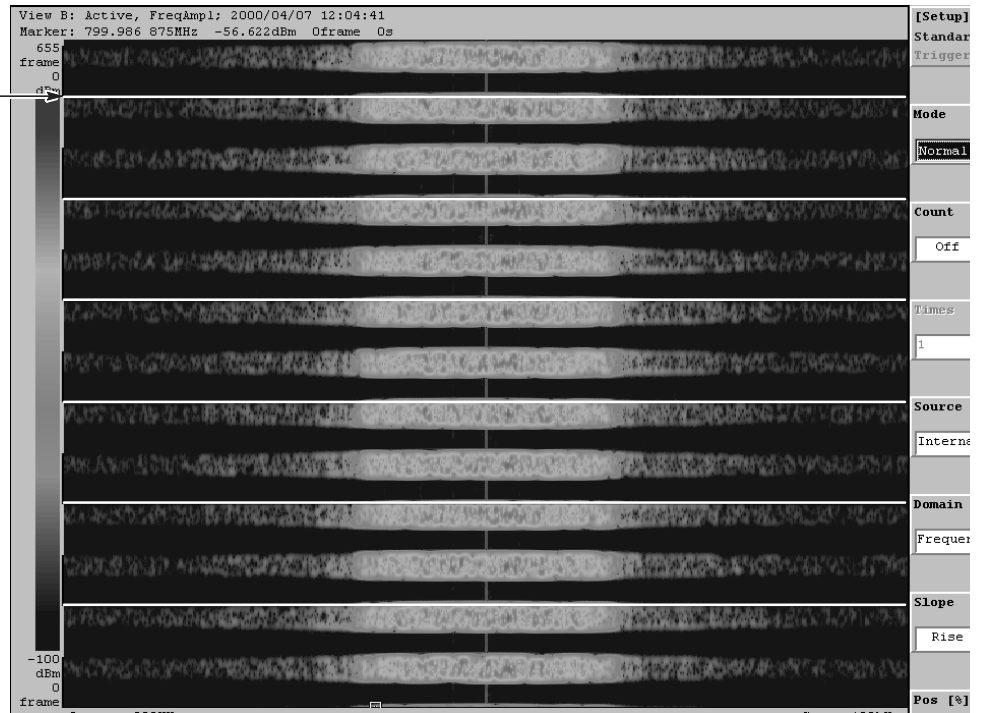

Figure 3-38: Three-dimensional view display effect by setting a trigger count

When Trigger Count is set to On, data is written into a different memory block for each trigger. Frame numbers are given sequentially. Figure 3–39 shows an example when Trigger Count is set to 4.

Example.
Trigger count = 4
Block size = 512 frames

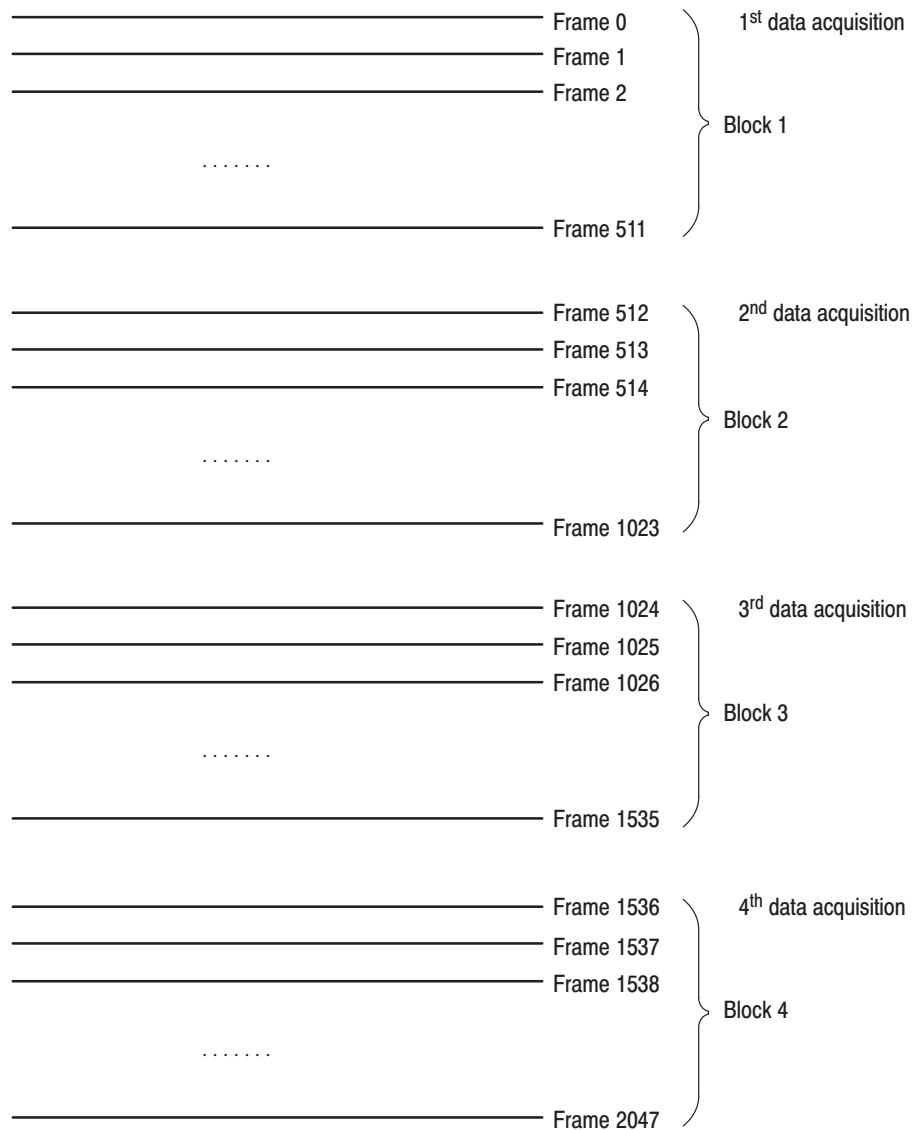

Figure 3–39: Relation between the trigger count and the frame

- Trigger Source** You can specify an internal or external trigger source.
- For the internal trigger, the trigger register which contains a trigger mask pattern is used. For how to create trigger mask patterns, refer to page 3–75.
- For the external trigger, a trigger is caused by the rising edge of a signal input through the EXT TRIG connector on the front panel.
- Setting.**
- Press **SETUP:MAIN** → **Trigger...** → **Source** and select either **Internal** (internal source) or **External** (external source).
- Trigger Domain** You can generate a trigger in the time or frequency domain.
- Setting.** A trigger domain is set automatically under the following conditions:
- With Format set to FreqAmpl in the Waveform view, the trigger domain is automatically set to the frequency domain when you press the Draw Max, Draw Line, Draw Min or Draw Horizontal side key in the Edit... submenu to create a trigger mask pattern.
- With Format set to TimeAmple in the Waveform view, the trigger domain is automatically set to the time domain when you do the same operations.
- Use the following procedure to set the trigger domain manually:
- Press **SETUP:MAIN** → **Trigger...** → **Domain** and select **Time** (time domain) or **Frequency** (frequency domain).
- Trigger Slope** With the trigger source set to Internal and the trigger slope set to Rise, the trigger occurs when a signal exits the blue area of a trigger mask pattern and enters into black area. Likewise, with the trigger slope set to Fall, the trigger occurs when a signal exits the black area and enters into blue area.
- With the trigger source set to External, the rising edge of an external input signal generates a trigger. You cannot select the trigger slope.
- Setting.**
- Press **SETUP:MAIN** → **Trigger...** → **Slope** and select **Rise** or **Fall**.

Trigger Position

The position specifies what percentage of all the frames in one block the acquired frames must account for when a trigger occurs.

Setting.

- Press **SETUP:MAIN** → **Trigger...** → **Pos** and set the trigger position in %. All the frames contained in one block are equivalent to 100 %. The default is 50%.

How to acquire data depends on the trigger mode (see Figure 3–40).

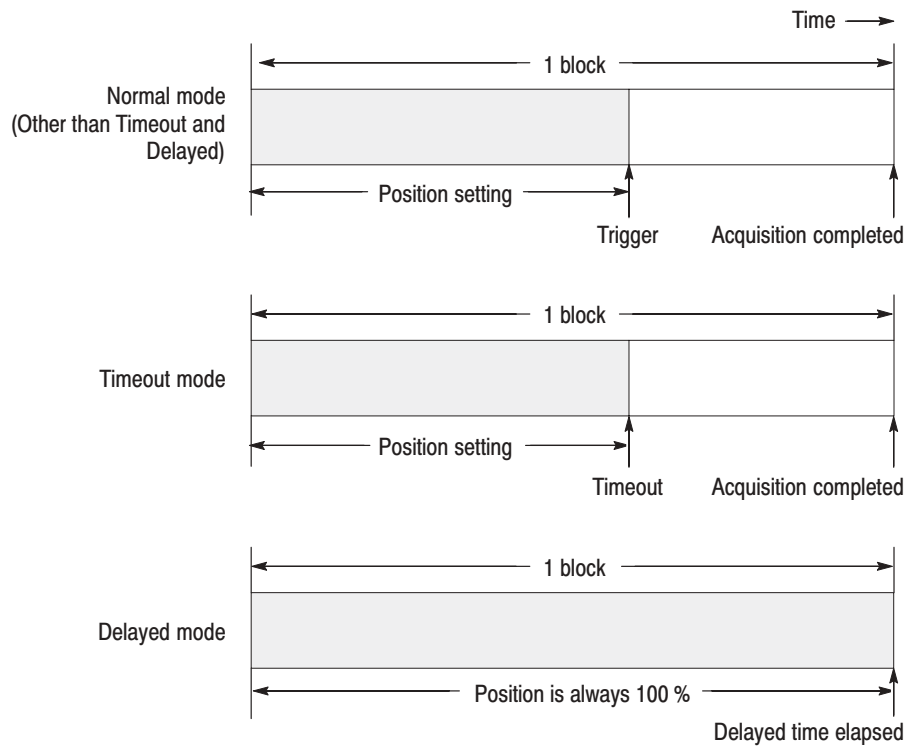

Figure 3–40: Trigger position and data acquisition

Creating a Trigger Mask Pattern

The trigger mask pattern is a two-dimensional mask pattern for triggering. For a frequency domain signal, this pattern is used to cause a trigger event with the frequency and amplitude level. For a time domain signal, it is used to cause the trigger event with the time and amplitude level.

Figure 3-41 shows an example of a trigger mask pattern. It contains blue and achromatic areas (shown in white) on the screen. When the spectrum exceeds a boundary between two types of areas, this causes the trigger. You can create a mask pattern by operating the marker in the spectrum display. The pattern you create is saved in the internal trigger register. Refer to *Trigger* on page 3-65 for other trigger settings.

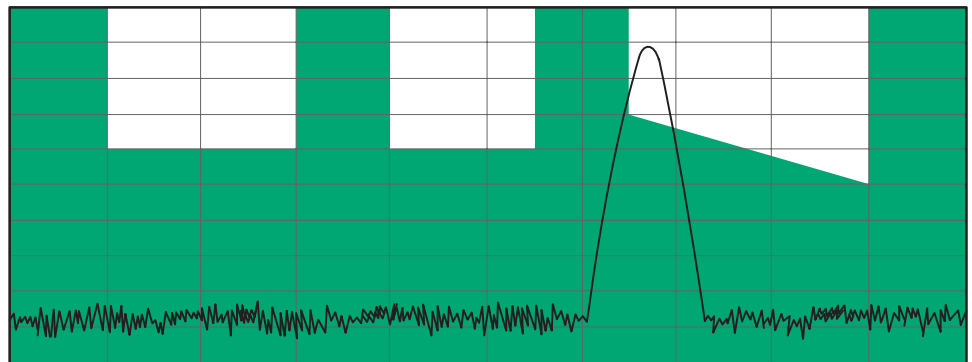

Figure 3-41: Example of a trigger mask pattern

Hints for Creating a Mask Pattern

- You can create a mask pattern only in the Waveform view.

You can cause the trigger in a two-dimensional space of the frequency or time and amplitude, so you have to select the format as follows:

VIEW:A (for example) → VIEW:Main → **Format** →
FreqAmpl or **TimeAmpl**

- You have to acquire a waveform with appropriate frequency, span, and reference level settings before creating a mask pattern.
- The trigger mask pattern contains blue and achromatic areas.

You can set the trigger with SETUP:MAIN → **Trigger...** → **Slope** as follows:

Rise — The trigger occurs when the spectrum enters the achromatic area from the blue area.

Fall — The trigger occurs when the spectrum enters the blue area from the achromatic area.

- The trigger register has areas to store both the time and frequency domain mask patterns. You can store two different domain patterns in different areas of a single trigger register.

When the trigger register contains both the frequency and the time domain mask patterns and you attempt to cause the trigger in the frequency domain, only the frequency domain pattern in the trigger register will be used. If you attempt to cause the trigger in the time domain in the same condition, only the time domain pattern will be used.

- Before you can acquire data using the mask pattern that you have created, make sure that the trigger source, span, and FFT windows are set as follows:

Trigger source: Internal
(SETUP:MAIN → **Trigger...** → **Source** → **Internal**)

Span ≤ 5 MHz
(SETUP:SPAN → ≤ 5 MHz)

FFT window: Blackman-Harris
(SETUP:MAIN → **Memory Mode, Input, FFT...** → **FFT Window** → **Blackman**)

When you use a mask pattern for triggering, the trigger mode is set to **Normal** automatically.

Example of Creating a Mask Pattern

Use the edit marker to create a mask pattern. You can operate the edit marker almost in the same manner as the delta marker. The difference is that you can also move it vertically.

1. Acquire a waveform with appropriate frequency, span, and reference level settings before creating a mask pattern.
2. If you desire, switch the background color of the screen to white: Press **CONFIG:VIEW** → **Options...** → **Background Color** and select **White**.
3. Select the view. For example, if you have defined View B for the Waveform view, press the **VIEW:B** key.

You do not need to keep a waveform (such as a spectrum) displayed in the Waveform view. However, displaying a waveform will help you create a pattern meeting the measurement conditions.

4. Press **VIEW:MAIN** → **Edit...** to display the mask edit menu.
5. Create the mask pattern.

For example, to create the pattern shown in Figure 3–41, first create achromatic area A.

- a. Press the **Draw Max** side key.
- b. Place the marker at A–L using the **Hor.** and **Ver.** side keys.

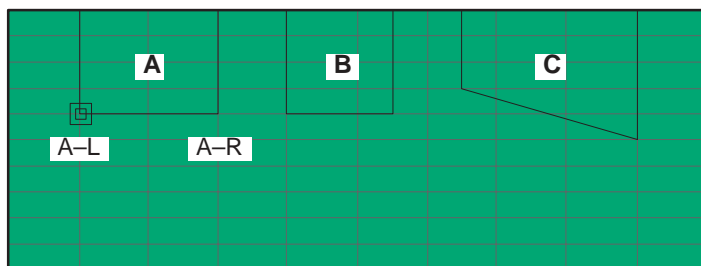

- c. Press the **Toggle Delta** side key to change the □ marker position with the ◇ marker.

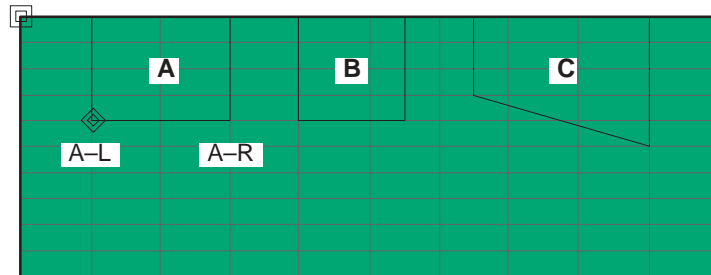

- d. Move □ to A-R using the **Hor.** and **Ver.** side keys.

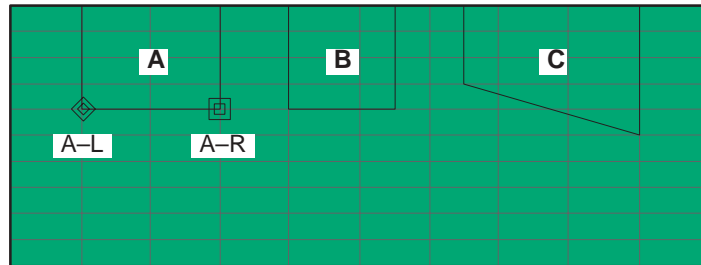

- e. Press the **Draw Line** side key. The white area is created as shown below.

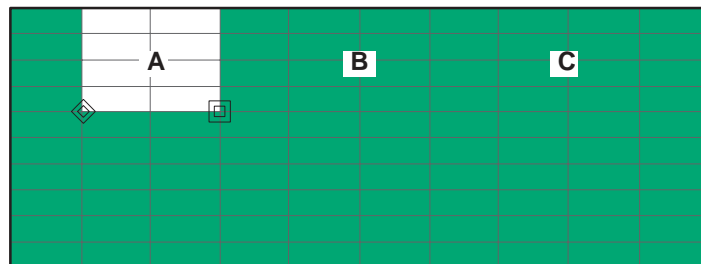

- f. Using steps from b to e, create areas B and C.

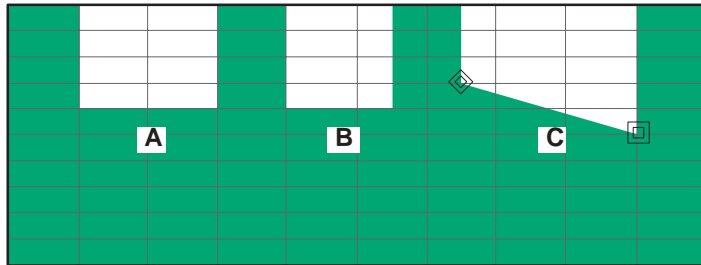

The trigger mask pattern you created is written into the internal trigger register.

Moving the Baseline

You can move the trigger mask baseline as shown in Figure 3–42. Use one of the following operations under step 5a on page 3–77 to move the baseline.

- To place the baseline at the reference level:
Press the **Draw Max** side key.
- To place the baseline at the level 70 dBm lower than the reference level:
Press the **Draw Min** side key.
- To place the baseline between the reference level and the level 70 dB lower than the reference level: Move the edit marker (□) to a specified position using the Hor. and Ver. side keys, then press the **Draw Horizontal** side key.

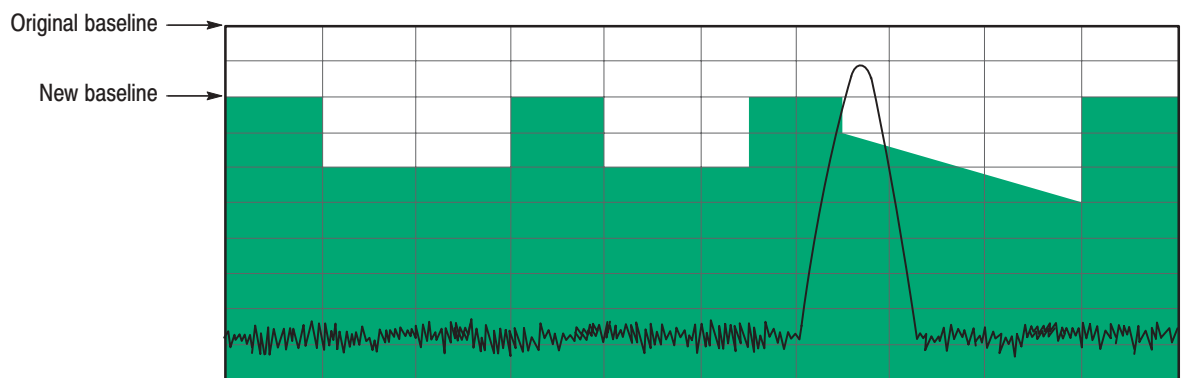

Figure 3–42: Example of a trigger mask pattern with a shifted baseline

Power Measurement

The following power measurements are available:

Noise — Noise per frequency (dBm/Hz)

Power — Power of the specified frequency area (dBm)

C/N — Proportion of carrier to noise (dB)

C/No — Proportion of carrier to noise per frequency (dB/Hz)

ACP — Leakage power of adjacent channel (dB)

OBW — Occupied bandwidth

Setting Requirements

Restrictions The following restrictions are imposed on the power measurements:

- Measurement is enabled only for the Waveform view and 3gppACPView.
- Only Blackman-Harris (default) is enabled for the FFT window.

Select **Memory Mode, Input, FFT... → FFT Window → Blackman** from the SETUP menu. If you set an FFT window other than Blackman-Harris, the result will not be displayed. For the FFT window, refer to *FFT parameters* on page 3–15.

- Measurement can be performed for data captured in the vector mode.

In the vector mode, one frame of data is acquired by one scan. When the input mode is Baseband, IQ, or Wide, the analyzer is always in the vector mode. When in the RF mode, the analyzer is in the vector mode with the span of 6 MHz or less.

Marker Operations To perform power measurement, you have to use special markers called “band power markers” as well as the ordinary markers. For details, refer to *Marker Operations and Peak Search* on page 3–45 and *Band Power Marker Operations* on page 3–90.

The power per frequency measured with the markers is calculated by the bandwidth per bin. For the bandwidth per bin, refer to *Relation among Frame, Bin, and Pixel* on page 3–41.

Using an Averaged Waveform You must use an averaged waveform in any power measurement, although it may not appear in the following operation descriptions. Select **Source → Average** in the Waveform view or 3gppACPView. For averaging, refer to *Averaging and Peak Hold* beginning on page 3–57.

Noise Measurement

The Noise measurement measures the noise per frequency (dBm/Hz) readout. The value of the vertical component at the marker position is divided by the bandwidth of the bin.

To measure noise, follow this procedure:

1. Display the spectrum in the Waveform view (or 3gppACPView for the 3GPP standard).
2. From the view menu, select **Options...** → **Scale, Marker, Search...** → **Marker...** → **Measurement** → **Noise**.
3. Move the marker to the desired data point.
4. Read the measured value displayed at the top left corner on the view.
5. When necessary, press the **ROLL** or **BLOCK** key to acquire the signal while measuring the noise.

Figure 3–43 shows a noise measurement example.

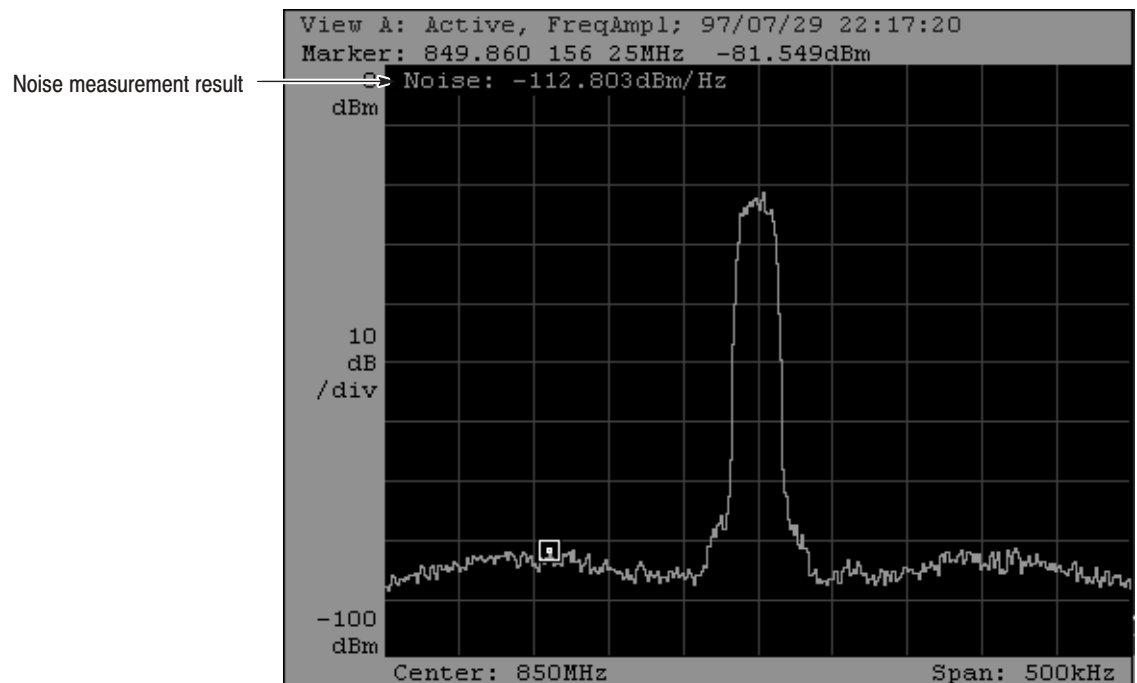

Figure 3–43: Noise measurement example

Power Measurement

The Power measurement measures the power (dBm) of the frequency region specified with the band power marker. For band power marker operations, refer to page 3–90.

To measure power, follow this procedure:

1. Display the spectrum in the Waveform view (or 3gppACPView for the 3GPP standard).
2. From the view menu, select **Options...→ Scale, Marker, Search...→ Marker...→ Measurement → Power**.
3. Use the band power marker to bracket the desired frequency region as shown in Figure 3–44.
4. Read the measured value displayed at the top left corner on the view.
5. When necessary, press the **ROLL** or **BLOCK** key to acquire the signal while measuring power.

Figure 3–44 shows a power measurement example.

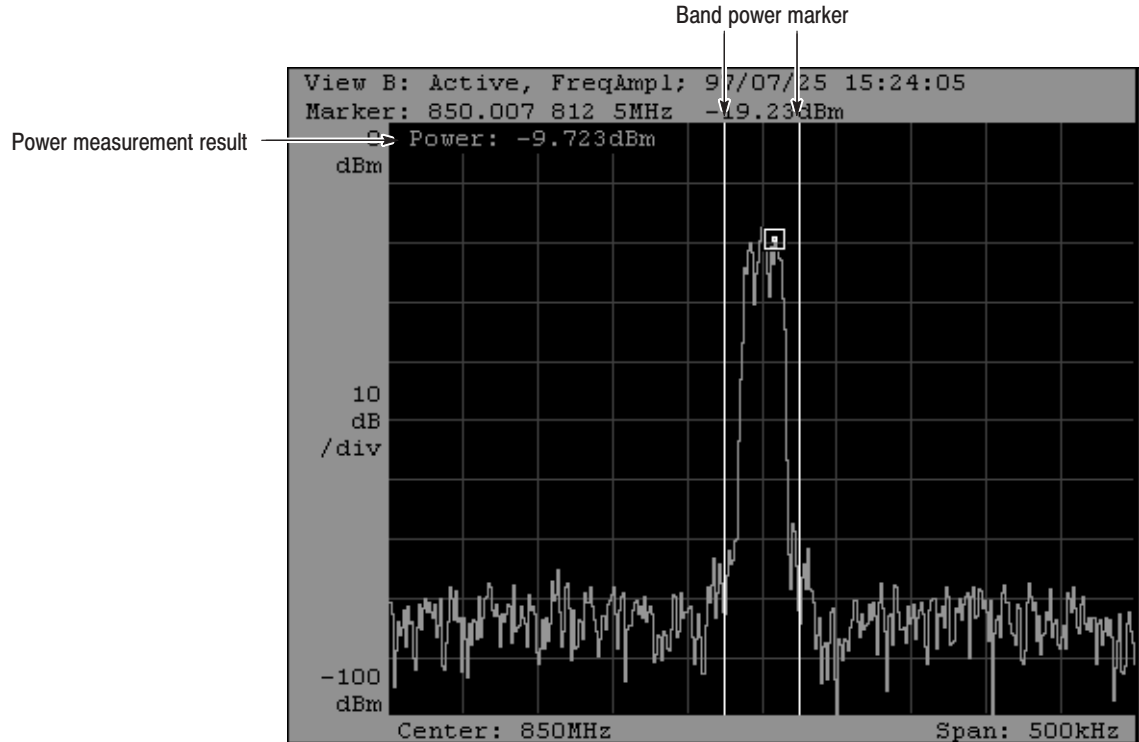

Figure 3–44: Power measurement example

C/N and C/No Measurements

The C/N measurement measures the power proportion (dB) of carrier to noise. The C/No measurement measures the power proportion (dB/Hz) of carrier to noise per frequency. For the carrier signal measurement, use the marker. For the noise measurement, use the band power marker. For the band power marker operations, refer to page 3–90.

To measure C/N or C/No, follow this procedure:

1. Display the spectrum in the Waveform view (or 3gppACPView for the 3GPP standard).
2. Select the following from the view menu:
For the C/N measurement: **Options...** → **Scale, Marker, Search...** → **Marker...** → **Measurement** → **C/N**
For the C/No measurement: **Options...** → **Scale, Marker, Search...** → **Marker...** → **Measurement** → **C/No**
3. Move the marker to the measurement point. Use the marker search function as appropriate.
4. Use the band power marker to select a noise frequency region.
5. Read the measured value displayed at the top left corner on the view.
6. When necessary, press the **ROLL** or **BLOCK** key to acquire the signal while measuring C/N or C/No.

Figure 3–45 shows C/N and C/No measurement examples.

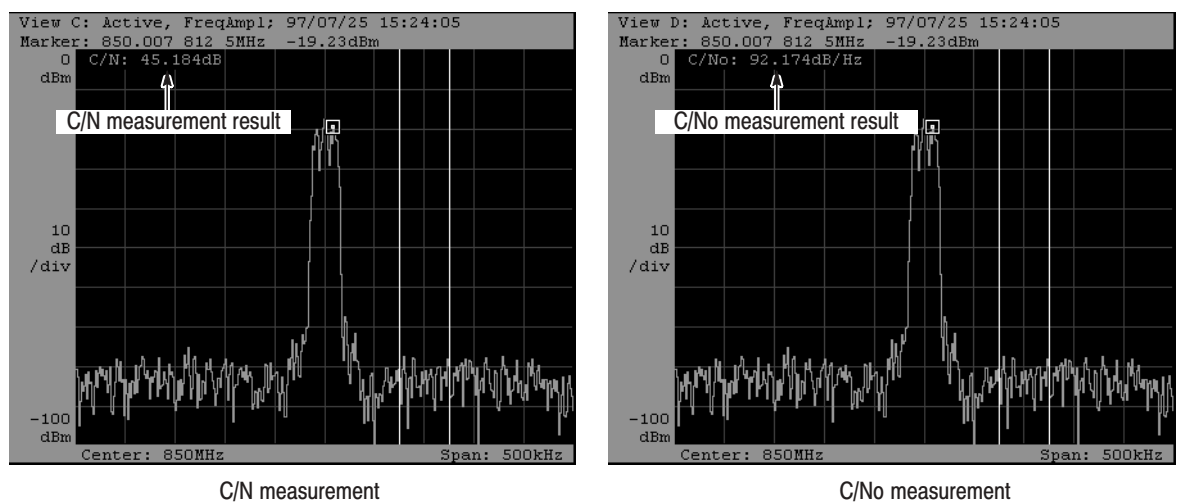

Figure 3–45: C/N and C/No measurement examples

ACP Measurement

The ACP (Adjacent Channel Leakage Power) measurement measures the power proportion (dB) of a signal appearing in a frequency region adjacent to the carrier signal frequency (the carrier signal). Use three band power markers specialized for ACP measurement: Center, Upper, and Lower. For the band power marker operations, refer to page 3–90.

To measure ACP, follow this procedure:

1. Display the spectrum in the Waveform view (or 3gppACPView for the 3GPP standard).
2. From the view menu, select **Options...** → **Scale, Marker, Search...** → **Marker...** → **Measurement** → **ACP**.
3. Press the **ACP...** side key and set the band power marker as follows:
 - a. Press the **Center Lock** side key and select **On** to fix the Center band power marker at center. (It is always On for the 3gppACPView.)

You can move the marker independently.
 - b. Press the **BW** side key and input the bandwidth.
 - c. Press the **SP** side key and input the frequency interval between two adjacent channels.
 - d. You can display the Upper and Lower band power markers by selecting **Band Power Markers** → **Upper** and **Lower**, respectively.
4. Read the measured value displayed at the top left corner on the view.
 - ACP Upper (dB) indicates the power proportion of the low frequency adjacent channel signal to the carrier signal.
 - ACP Lower (dB) indicates the power proportion of the high frequency adjacent channel signal to the carrier signal.

5. When necessary, press the **ROLL** or **BLOCK** key to acquire the signal while measuring the ACP.

Figure 3–46 shows an ACP measurement example.

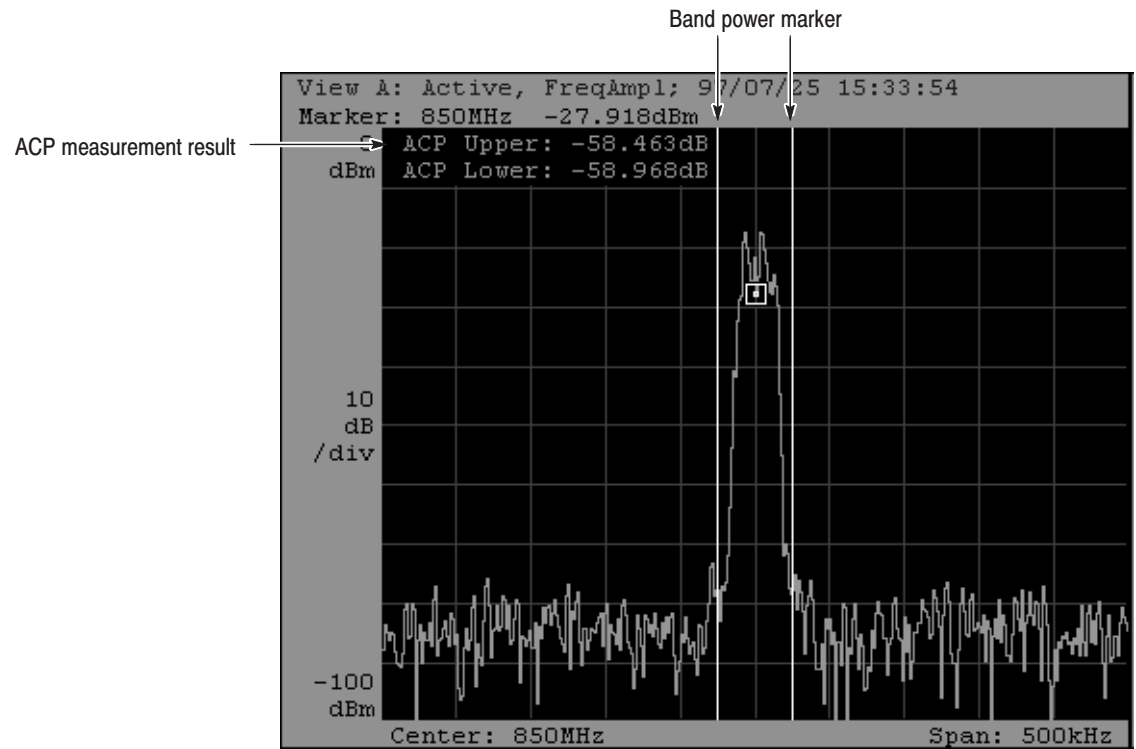

Figure 3–46: ACP measurement example

OBW Measurement

The OBW (Occupied Bandwidth) measurement obtains the frequency bandwidth so that the power proportion of the carrier signal to the entire power of the span frequency region equals the specified proportion. In this measurement, you can input only the proportion (Pr) although it displays the band power markers.

To measure OBW, follow this procedure:

1. Display the spectrum in the Waveform view (or 3gppACPView for the 3GPP standard).
2. From the view menu, select **Options...** → **Scale, Marker, Search...** → **Marker...** → **Measurement** → **OBW**.
3. Press the **OBW** side key and input the desired proportion (Pr).
4. A band power marker is displayed in the view. Its center indicates the current center frequency of the instrument. When necessary, change the input value in step 3.
5. Read the measured value displayed at the top left corner on the view.
6. When necessary, press the **ROLL** or **BLOCK** key to acquire the signal while measuring the OBW.

Figure 3–47 shows an OBW measurement example.

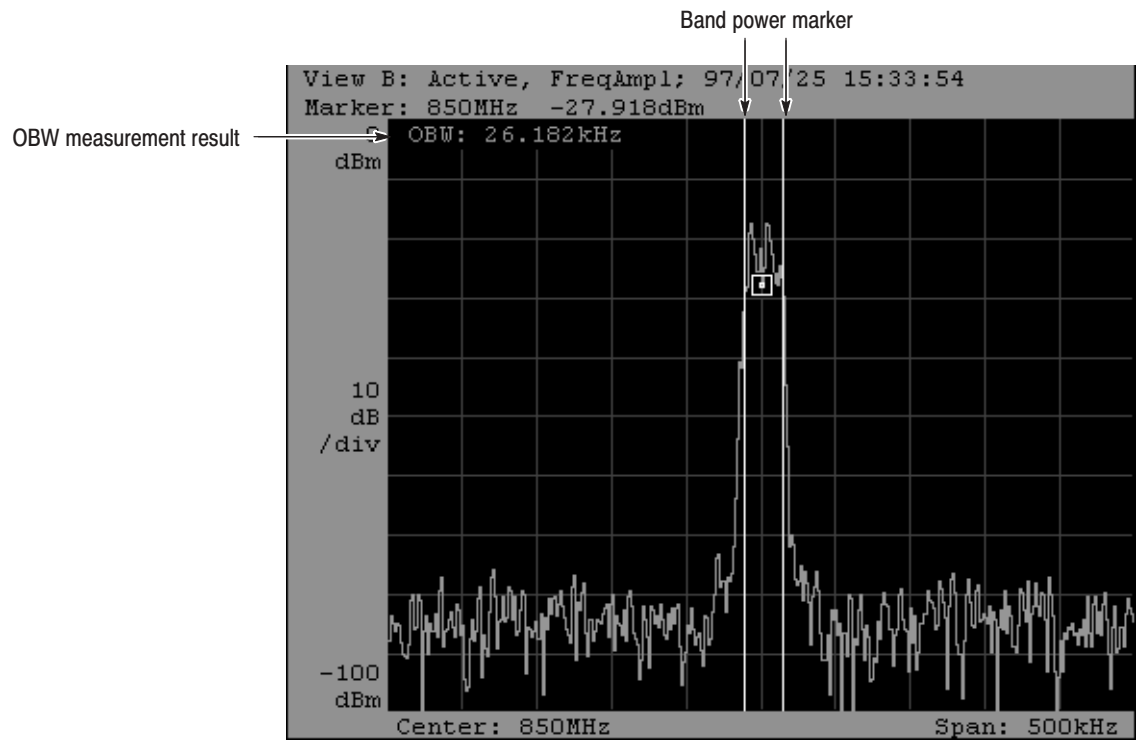

Figure 3-47: OBW measurement example

Band Power Marker Operations

The power measurement uses special markers called band power markers as well as the ordinary marker. The following three band power markers are available. Their operations depend on the measurement type.

- Power, C/N, and C/No measurements:
Power measurement band power marker
- ACP measurement: ACP measurement band power marker
- OBW measurement: OBW measurement band power marker

Power, C/N, and C/No Measurements

The band power marker is used to determine the bandwidth. See Figure 3–48. Two vertical cursors appear. Set the four related parameters to move the cursors. Use one of the following methods or both methods combined.

Determine the Center Frequency and Bandwidth.

1. Input the center frequency in **Options...** → **Scale, Marker, Search...** → **Marker...** → **Band Power Markers...**
2. Press the **Center** side key and input the center frequency.
3. Press the **Width** side key and input the bandwidth.
If it is set to 0, the power for one bin width will be calculated.

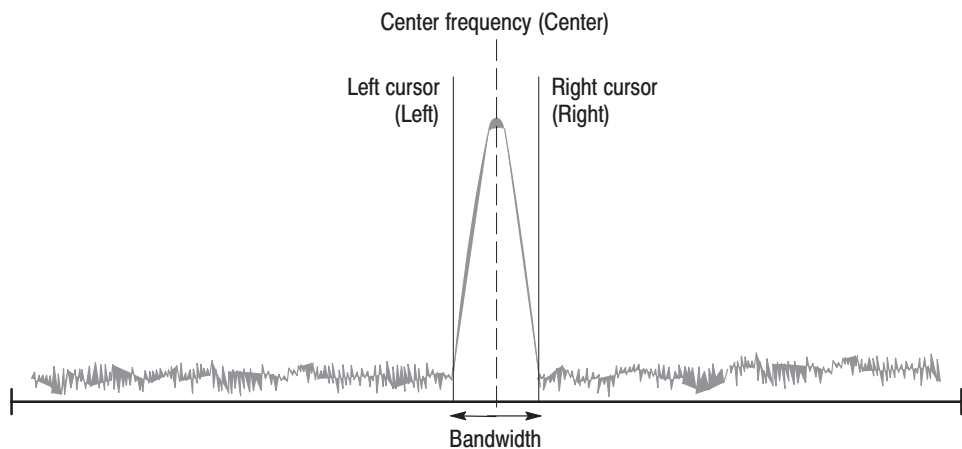

Figure 3–48: Power measurement band power marker

Determine the right and left cursor positions.

1. Input the frequency position of the right cursor in the **Options...→ Scale, Marker, Search...→ Marker...→ Band Power Markers...**
2. Press the **Right** side key and input the right cursor position.
3. Press the **Left** side key and input the left cursor position.

ACP Measurement

There are three band power markers. The Upper, Center, and Lower band power markers are used to obtain the power proportion of the upper and lower adjacent frequency channels to the carrier signal. See Figure 3–49.

The band power markers are set with the following three parameters:

- Carrier frequency: F_c
- Bandwidth: B_w
- Channel spacing: S_p

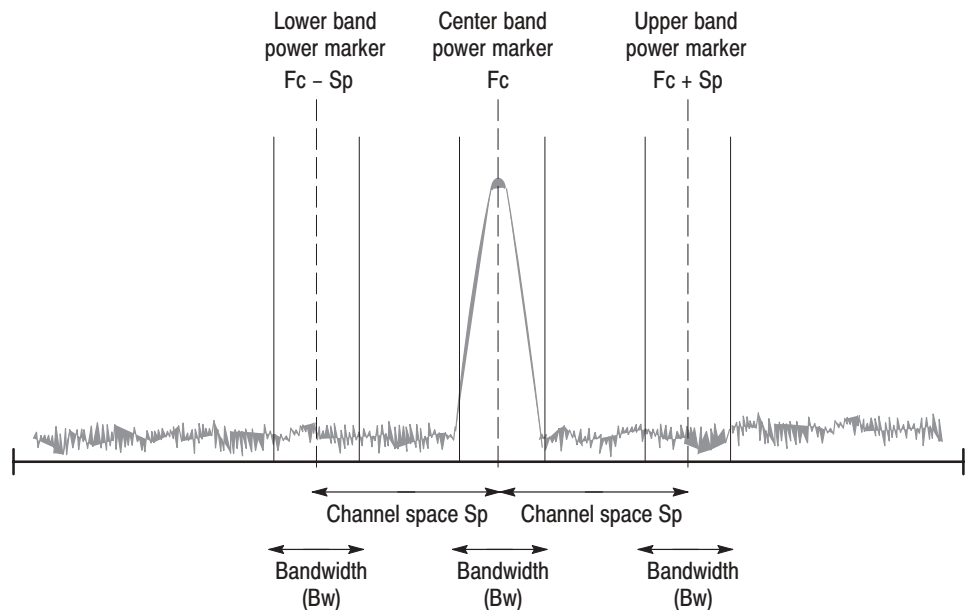

Figure 3–49: ACP measurement band power marker

Determine these parameters using the following procedure:

1. From the view menu, select **Options...** → **Scale, Marker, Search...** → **Marker...** → **Measurement** → **ACP**.
2. Press the **ACP...** side key to display the band power marker submenu.
3. Press the **Center Lock** side key and select **On** to fix the Center band power marker at center. (It is always On for the 3gppACPView.)

You can move the marker independently.

4. Press the **BW** side key and input the bandwidth.
5. Press the **SP** side key and input the frequency interval between two adjacent channels.
6. You can display the Upper and Lower band power markers by selecting **Band Power Markers** → **Upper** and **Lower**, respectively.

OBW Measurement

This band power marker is represented by two vertical cursors used to determine the bandwidth. It cannot be operated directly.

See Figure 3–50. T_p is the total power of the area represented by the frequency span. The analyzer obtains the power region X_p for which the proportion to T_p equals the value set in **Options... → Scale, Marker, Search... → Marker... → OBW**.

$$X_p = (Pr \times T_p)/100$$

From X_p , the analyzer obtains the bandwidth around the center frequency.

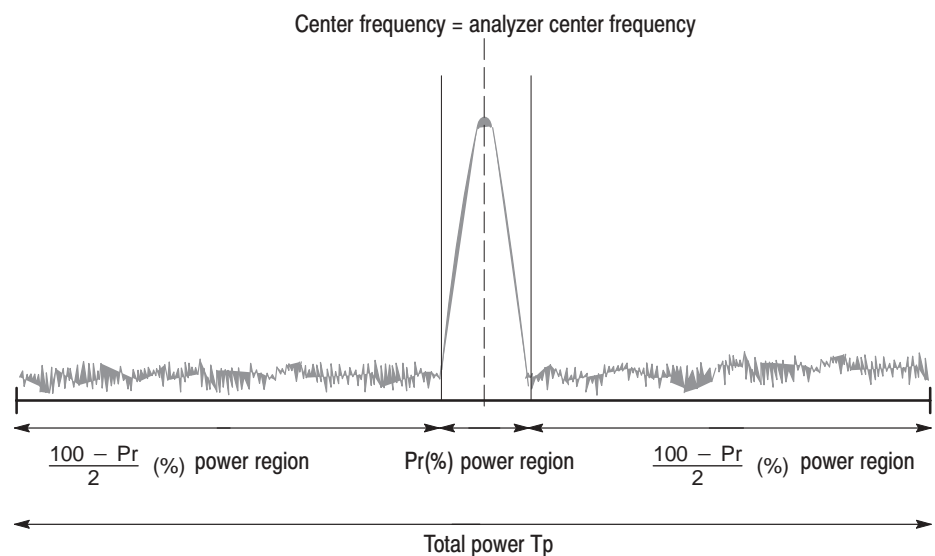

Figure 3–50: Band power marker used for the OBW measurement

To obtain OBW, follow this procedure:

1. From the view menu, select **Options... → Scale, Marker, Search... → Marker... → Measurement → OBW**.
2. Align the carrier signal center frequency in the analyzer center frequency position.
3. Press the **OBW** side key and input the proportion (Pr).

The analyzer calculates the occupied bandwidth and displays the result by the cursors and the value at the top left corner on the view.

Analyzing an Analog Modulated Signal

Use the Analog view to analyze an analog modulated signal. This view is capable of demodulating and displaying PM (phase modulation), AM (amplitude modulation), and FM (frequency modulation) signals.

Setting

Select the Dual or Zoom mode to provide the time domain data required to analyze an analog modulated signal. When displaying a signal, select the modulating system.

1. Press **CONFIG:MODE** → **Dual** or **Zoom**.
2. Set a proper frequency and span (refer to page 3–9).

The analyzer requires the proper span to recognize the analog modulation and display the signal. Set the span as close to the bandwidth as possible and fine-tune it.

3. Redefine the view:
 - a. Press the **CONFIG:VIEW** key.
 - b. Press one of the **VIEW:A** to **D** side keys.
 - c. Turn the general purpose knob to select **Analog**.If you want to define two or more Analog views, repeat steps b and c.
4. Select the modulating system:
 - a. Select the view you selected. For example, if you have defined View B as the Analog view, press the **VIEW:B** key.
 - b. Press the **Format** side key.
 - c. Turn the general purpose knob to select **AM**, **PM**, or **FM**.

Now, the analog signal can be demodulated and displayed on screen.

Display

The horizontal axis represents the time in all AM, PM, and FM demodulation displays. By default, the time duration matches the frame length (see Table 3–9 on page 3–29).

The vertical axis represents the modulation factor (%) in AM modulation display, the phase in PM demodulation display, and the frequency in FM demodulation display.

Figure 3–51 shows three display examples. In certain conditions, the Analog view cannot finely display the whole waveform when the default scale settings are used. In this case, use the auto scale function (refer to page 3–36).

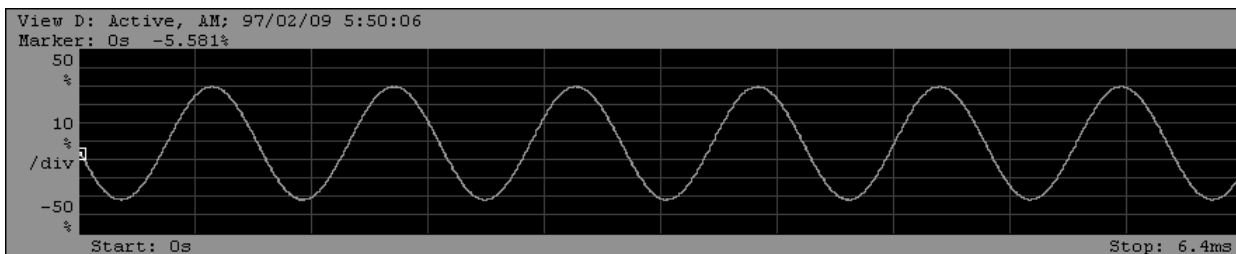

AM signal demodulation display example

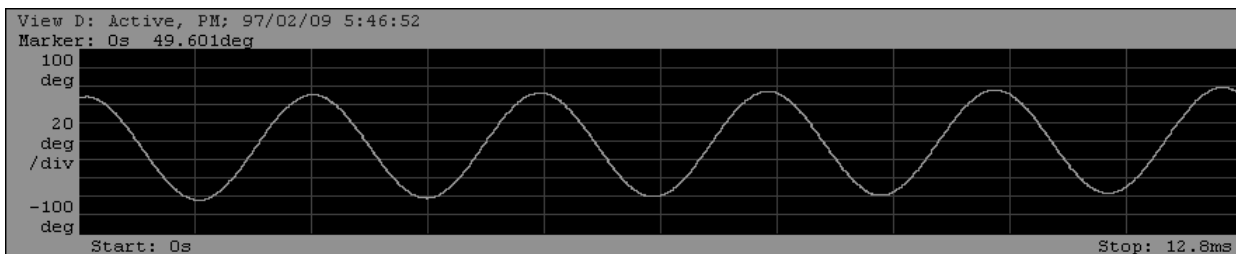

PM signal demodulation display example

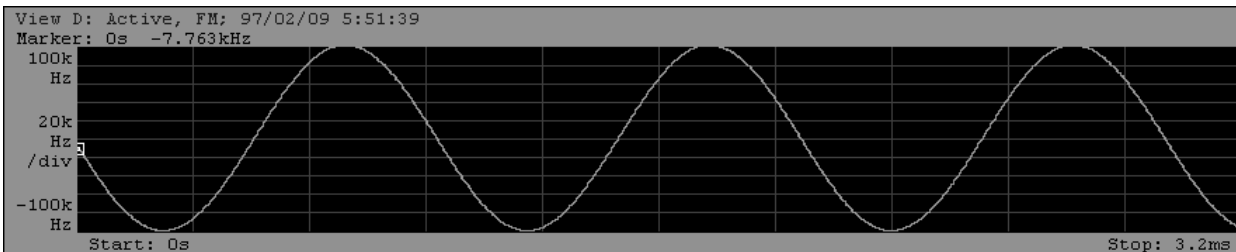

FM signal demodulation display example

Figure 3–51: Display examples of analog signal demodulation

Display and Analysis of a Digitally-Modulated Signal

There are several ways to analyze a digitally-modulated signal:

- Vector or constellation display in the Polar view (the CDMAPolar view for the IS-95 and T-53 standards, the codePolar view for the cdmaOne standard, the codeWPolar view for the W-CDMA standard, and the 3gppPolar view for the 3GPP standard)
- EYE diagram display in the EyeDiagram view
- Symbol table display in the SymbolTable view
- Error vector analysis display in the EVM view

Process Flow

Figure 3–52 outlines the digitally-modulated signal process taking place in the Polar view.

The Polar view is capable of demodulating and modulating digitally-modulated signals. Inputting the data obtained with the Polar view allows the EYE diagram display to be in the EyeDiagram view, symbol display to be in the SymbolTable view, and error vector analysis display to be in EVM view. So, the Polar view must always be kept in display in order to use these three views.

Supported Modulation Systems

The standard modulation systems are supported for the Polar view. For non-standard cases, you can specify the modulating system, symbol rate, filter, and α/BT .

Table 3–13: Modulating systems

Modulation system	Modulation	Symbol rate	Filter	α/BT
NADC	1/4 π QPSK	24.3 kHz	RootRaisedCosine	0.35
PDC	1/4 π QPSK	21 kHz	RootRaisedCosine	0.5
PHS	1/4 π QPSK	192 kHz	RootRaisedCosine	0.5
TETRA	1/4 π QPSK	18 kHz	RootRaisedCosine	0.35
GSM	GMSK	270.833 kHz	None	0.3
CDPD	GMSK	19.2 kHz	None	0.5
IS-95/T-53 ¹	CDMA_QPSK	1.2288 MHz	RootRaisedCosine	0.2

¹ IS-95 and T-53 can be set in the CDMA Polar view.

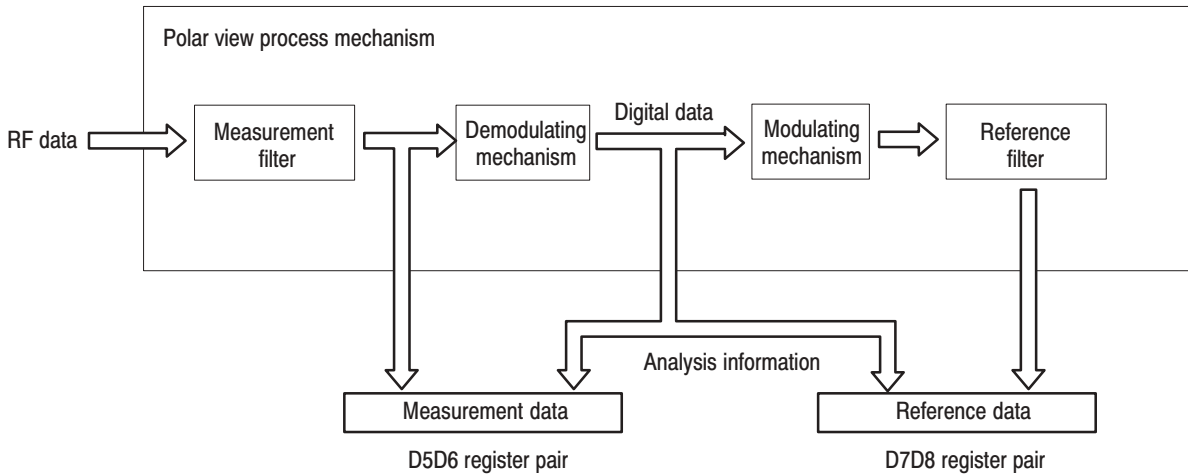

The measurement data and the reference data are stored in the registers called register pairs (D1D2, D3,D4, D5D6, and D7D8). By default, the measurement data is stored in the D5D6 register pair, and the reference data in D7D8.

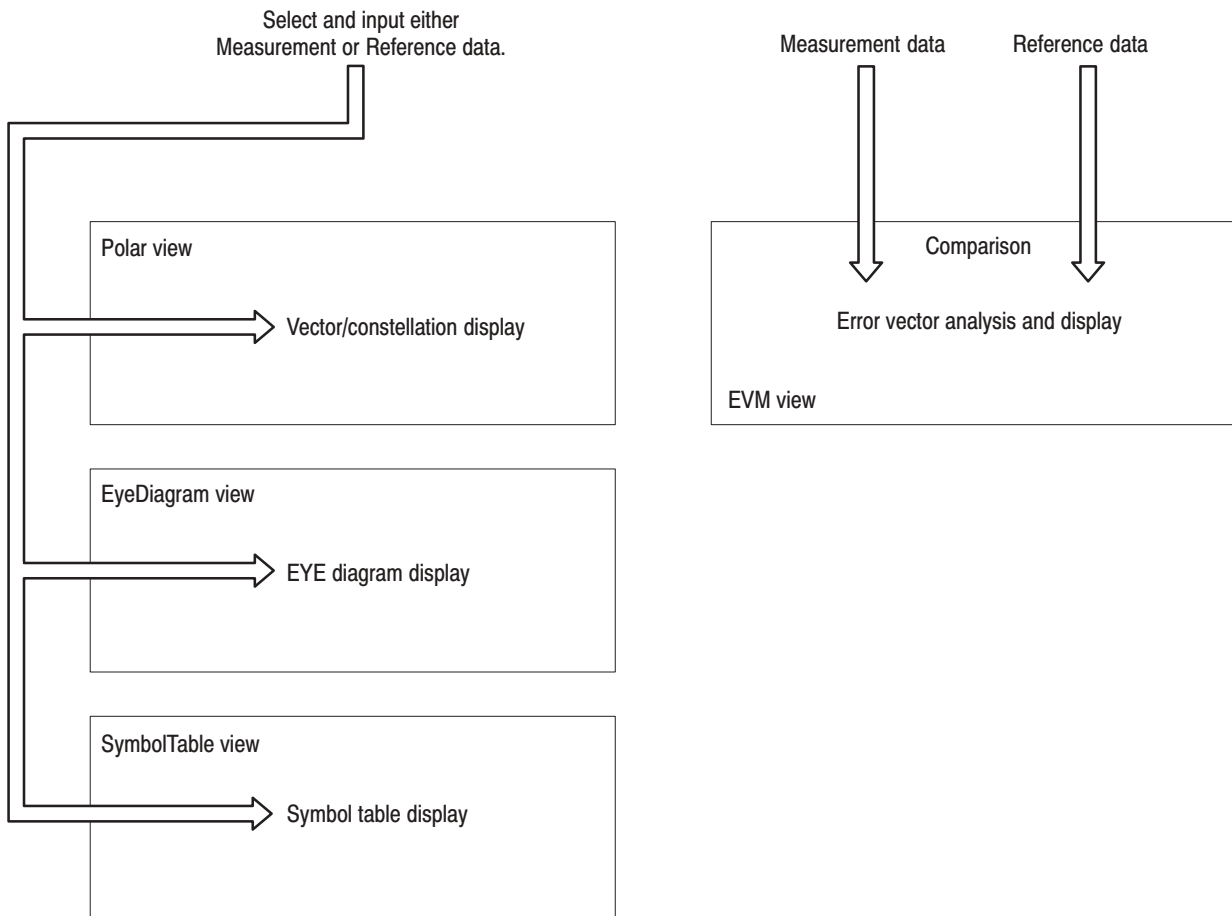

Figure 3-52: Digital modulation signal flow

Setting

Select the Dual or Zoom memory mode to provide the time domain data required to analyze a digitally-modulated signal. When you display the EyeDiagram, SymbolTable, or EVM view, be sure to display the Polar or CDMA Polar view also.

1. Press **CONFIG:MODE** → **More...** (twice) → **Digital Demod** to configure the analyzer for analyzing the digitally-modulated signal.

2. Select the view:

In step 1 above, the Waveform, Spectrogram, Polar, and EyeDiagram views are set by default. If necessary, set the SymbolTable or EVM view instead of the Waveform or Spectrogram view.

For example, define Views A to D as EVM (Format: EVM), EVM (Format: Phase Error), Polar, and EyeDiagram, respectively.

- a. Press the **CONFIG:VIEW** key.
- b. Press the View **A** side key and select **EVM**.
- c. Press the View **B** side key and select **EVM**.

Select the format in each EVM view. The format of the EVM view is EVM by default. Change the format of View B.

- d. Press the **VIEW:B** key, and then the **VIEW:MAIN** key.
 - e. Press the **Format** side key to select **Phase Error**.
3. Set a proper frequency and span (refer to page 3–9).

The analyzer requires the proper span to recognize the digital modulation and display the signal. Set the span as close to the bandwidth as possible and fine-tune it.

4. Select the modulating system or set the modulation parameters.

- a. Press the VIEW:C key to select the Polar view.

Select the modulating system:

- b. Select the **Standard...** side key.
- c. Press the appropriate side key to select the modulating system. Refer to *Supported Modulation Systems* on page 3–98.
- d. Press the [**View C**]<- side key (top side key) to return to the previous menu level.

If you set the modulation parameters manually, do the following steps:

- e. Press the **Manual Setup...** side key.
- f. Press the **Modulation** side key to select the modulating signal.
- g. Press the **Symbol Rate** side key to input the symbol rate.
- h. Press the **Measurement Filter** side key to select either **None** (no filter) or **RootRaisedCosine** for the measurement filter.
- i. Press the **Reference Filter** side key to select **None** (no filter), **RaisedCosine**, or **Gaussian** for the Reference filter.
- j. Press the **Alpha/BT** side key to input the α /BT value.

Now, the settings are complete. The EVM, phase error, vector and eye diagrams can be displayed. Then, press the **ROLL** or **BLOCK** key to acquire data.

Vector and Constellation Displays

The Polar view displays the digitally-modulated signal in the vector or constellation form. Select **Format** → **Vector** or **Constellation** in the Polar view.

Vector Display. The vector display uses the polar coordinate or IQ diagram to display signals represented by the phase and amplitude. Figure 3–53 (left) is an example showing a vector display of the signal in the $1/4 \pi$ QPSK modulation. The red points show the measurement symbol positions. The green trace shows the locus of shifts between symbols. Each point through which multiple concentrated traces pass corresponds to the symbol of the measurement signal. You can estimate the error vector size by comparing such points with the red points. The cross hairs show the symbol positions of the ideal signal.

Note that the symbol is not shown in the vector form in the CDMA Polar view.

Constellation Display. Figure 3–53 (right) shows a constellation display example. Like the vector display, the constellation shows the signal in the polar coordinate or IQ diagram. However, the constellation shows only the measurement signal symbols in red without displaying the symbol-to-symbol locus.

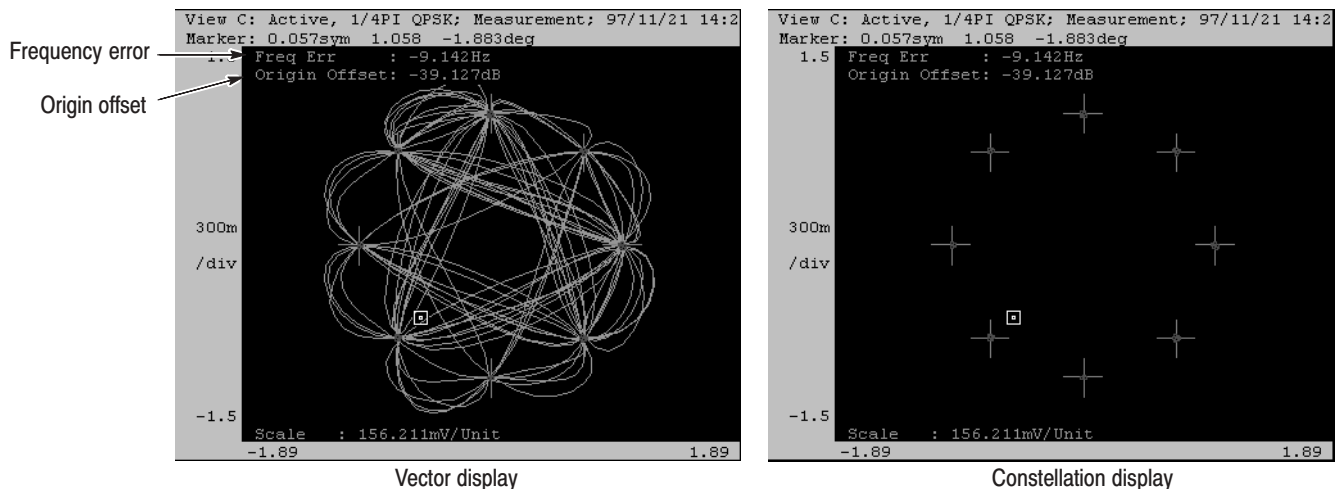

Figure 3–53: Vector and constellation display examples

On the upper left corner of the view, Freq. Err (frequency error) and Origin Offset are displayed.

- **Freq. Err** indicates the difference between the center frequency of the analyzer and the carrier frequency of the signal. Match the center frequency and the carrier frequency by setting the center frequency to the value of (Current center frequency + Freq. Err).
- **Origin Offset** indicates the shift of the origin of the polar coordinate for the ideal signal from that for the measurement signal. All the signals and measurement data in the Polar view are displayed after the origin shift has been corrected.

The Polar view can display the ideal signal as well as the measurement data. Select **Display** → **Measurement** (measurement data) or **Reference** (ideal signal) in the Polar view menu. Use the EVM view to obtain the errors quantitatively from the ideal digitally-modulated signal (refer to page 3–106) .

Eye Diagram Display

The EyeDiagram view inputs the signal processed in the Polar view and displays the eye diagram. The eye diagram represents symbol-to-symbol transitions by time and amplitude or phase. Figure 3–54 shows an example of the vector display of a signal in the $1/4 \pi$ QPSK modulation and Eye diagram display examples. Each point through which multiple concentrated lines pass represents a symbol. You can set the symbol transition length with **Eye Length** in the EyeDiagram view menu.

The EyeDiagram view can display the ideal signal as well as the measurement data. Select **Display** → **Measurement** (measurement data) or **Reference** (ideal signal) in the EyeDiagram view menu. You can observe the size of disorder in the eye diagram by switching the display with the general purpose knob. To obtain the errors quantitatively from the ideal digitally-modulated signal, use the EVM view (refer to page 3–106).

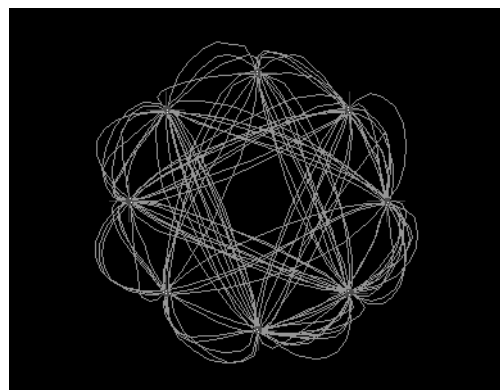

Vector display

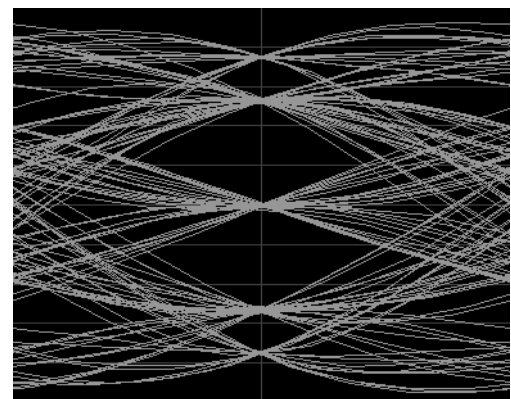

Eye diagram display
(1-symbol transition length)

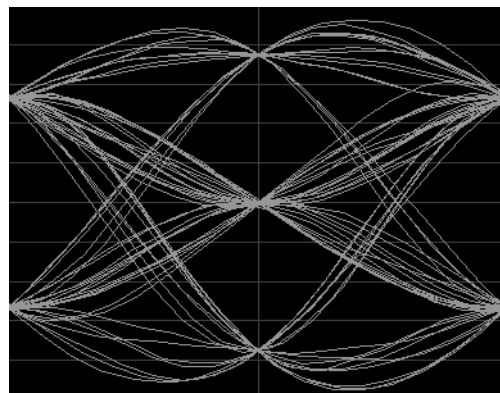

Eye diagram display
(2-symbol transition length)

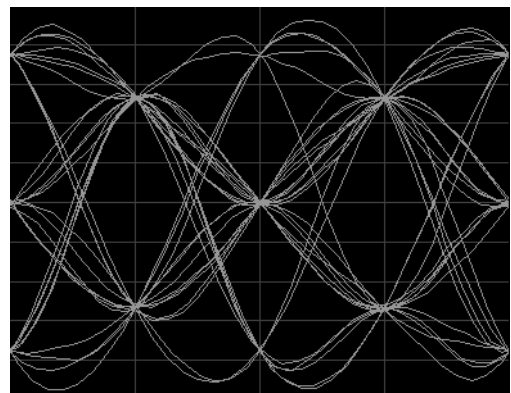

Eye diagram display
(4-symbol transition length)

Figure 3–54: Vector and Eye diagram display examples

Symbol Table Display

The SymbolTable view inputs the signal processed in the Polar view and displays the demodulated digital data in a bit string form.

The bit strings can be represented in binary, octal, or hexadecimal notation. Select one of them with **Radix** in the SymbolTable view menu. For the BPSK, QPSK, 8 PSK, or QAM modulating system, the start position of digits is merely a relative position of symbols, so you can change it with **Rotate** in the SymbolTable view menu.

Figure 3–55 shows an example of a bit pattern symbol table obtained by demodulating the $1/4 \pi$ QPSK modulated signal.

The SymbolTable view can display the ideal signal as well as the measurement data. Select **Display** → **Measurement** (measurement data) or **Reference** (ideal signal) in the SymbolTable view menu.

```

0: 00000010 00100001 11110011 00111011 11010101
20: 01100111 00000000 10101101 11111100 00010011
40: 11110111 10010111 11001110 10001111 01011000
60: 11011100 00101101 00110111 00010001 01001101
80: 10011000 01010010 10101110 00010000 00011011
100: 10011111 10100110 10111110 00101000 01111011
120: 00001110 11100101 11011001 10100011 00101010
140: 00110101 00000011 01000001 11110100 01111011
160: 11000110 11100111 01101001 10101100 10001010
180: 00010100 11000011 10000101 01110110 11100000
200: 11001001 10111101 01001010 01110000 01000010
220: 11011110 01110001 00111010 11011001 01100001
240: 00101000 10

```

Figure 3–55: Symbol table display example

Error Vector Analysis Display

The EVM view inputs both the measurement signal and ideal signal, which has been processed in the Polar view, to display the difference as error magnitude. With the EVM view, you can obtain the error quantitatively at each data point.

The EVM view is shown with time along the horizontal axis and error magnitude along the vertical axis. The red points represent the symbol positions of the measurement signal, and the green traces represent the differences between the measurement signal and ideal signal.

Figure 3–56 shows the examples of the EVM view of the $1/4 \pi$ QPSK modulated signal (each view is auto-scaled). You can select three formats of **EVM**, **Mag Error**, and **Phase Error** with **Format** in the EVM view menu.

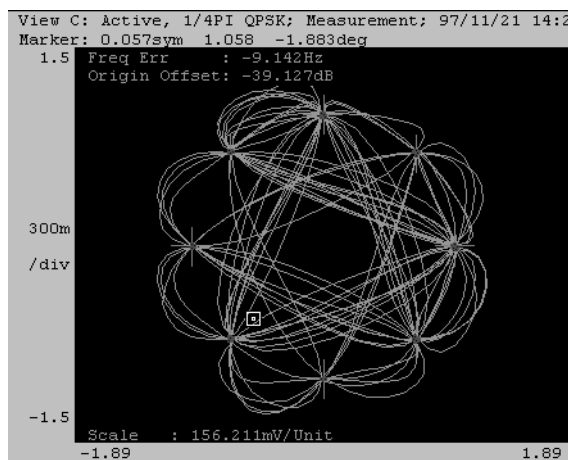

Vector display

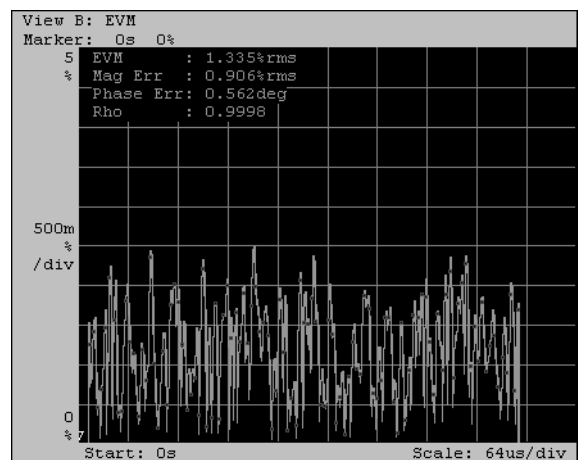

EVM display

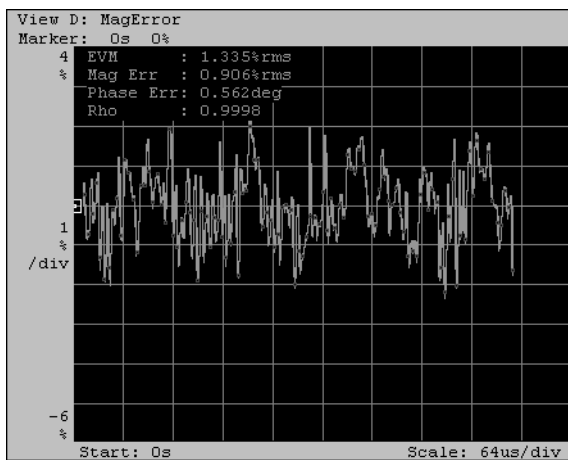

Mag Error display

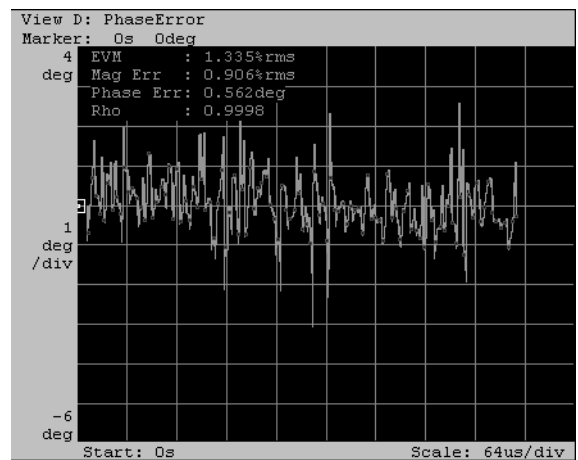

Phase Error display

Figure 3–56: EVM view display examples

The constellation display of the $1/4 \pi$ QPSK modulation is shown for the three formats of **EVM**, **Mag Error**, and **Phase Error** (see see Figure 3–57).

The cross-hairs, called symbol, represent the phase positions of the ideal signal (in this case, the amplitude is fixed). In this modulating system, the bit pattern is determined by shifts from the individual positions. For example, suppose that an actual signal has shifted to the ● position from the ideal symbol position. You can evaluate the quality of the modulated signal as an error in the radial (amplitude) direction, an error in the phase direction, and the total error vector, which correspond to Mag Error, Phase Error, and EVM formats, respectively.

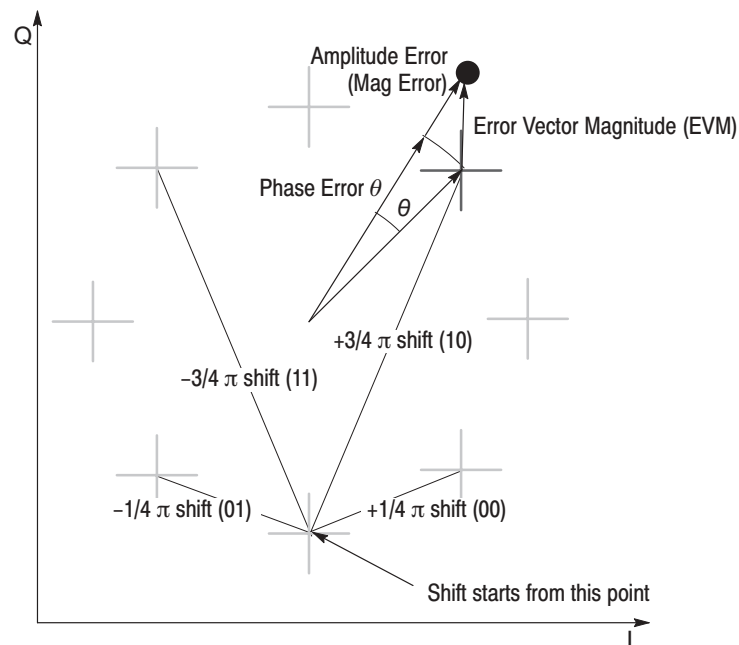

Figure 3–57: $1/4 \pi$ QPSK constellation display example and error vector

In each of these three display formats, the following error information is commonly shown:

- Mag error (% RMS): Root-mean-square of the amplitude error
- Phase error (deg): Root-mean-square of the phase error
- EVM (% RMS): Root-mean-square of the EVM (Error Vector Magnitude)
- Rho: ρ meter

The Rho (ρ meter) indicates the waveform distortion. It is represented with the following equation:

$$\rho (Rho) = \frac{\left| \sum_{k=1}^M R_k Z_k^* \right|^2}{\sum_{k=1}^M |R_k|^2 \sum_{k=1}^M |Z_k|^2}$$

Where, R_k is the ideal IQ signal point data represented by the complex number, and the Z_k is the measurement IQ signal point data represented by the complex number.

Analyzing an FSK Digital Modulated Signal

The analyzer can demodulate and display an FSK (Frequency Shift Keying) signal using the FSK view. This section describes the setting and display of the FSK view.

Setting

Select the Dual or Zoom memory mode to provide the time domain data required to observe an FSK modulated signal.

1. Press the CONFIG:**MODE** key.
2. Press **Dual**, **Zoom**, or **Digital Demod** side key to set up the analyzer with the basic configuration.
3. Set a proper frequency and span (refer to page 3–9).

The analyzer requires the proper span to recognize the digital modulation and display the signal. Set the span as close to the bandwidth as possible and fine-tune it.

4. Redefine the view:
 - a. Press the CONFIG:**VIEW** key.
 - b. Press one of the VIEW:**A** to **D** side keys.
 - c. Turn the general purpose knob to select **FSK**.

If you want to define two or more FSK views, repeat steps b and c.

Now, the FSK signal can be demodulated and displayed on screen.

Display

The FSK view displays the demodulated signal with time along the horizontal axis and frequency along the vertical axis. Figure 3–58 shows an example of a demodulated FSK modulated signal. By default, the horizontal axis scale is set to the frame length (see Table 3–9 on page 3–29) and the vertical axis scale is set to the span. The default scale settings may not be enough to finely display the whole waveform. In this case, use the auto scale function (refer to page 3–36).

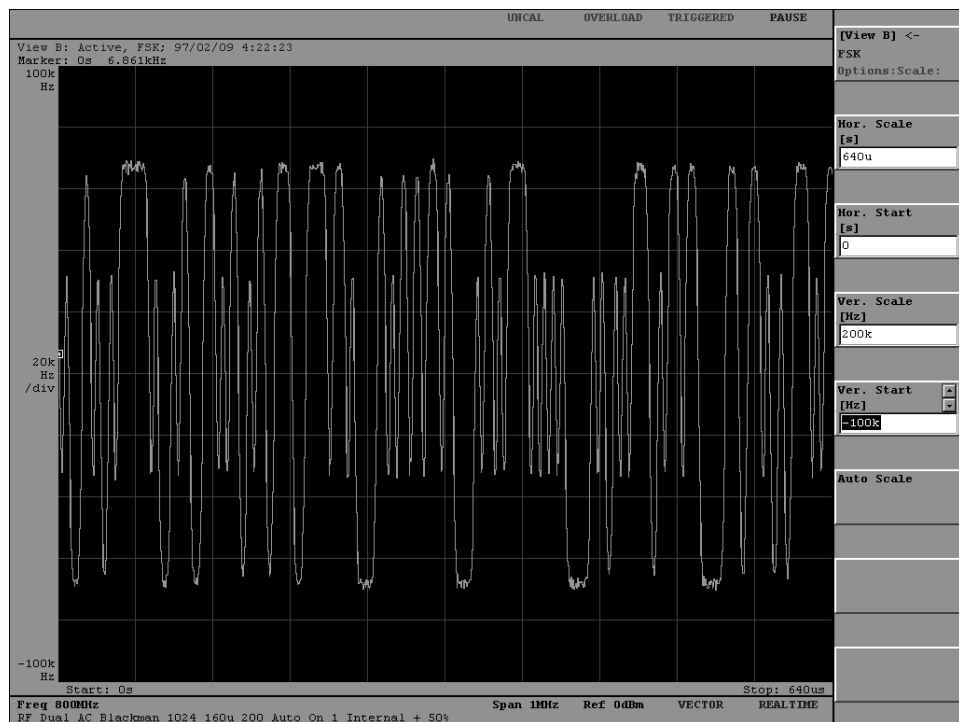

Figure 3–58: Example display of FSK modulation signal demodulation

CDMA Analysis

A signal that a mobile station transmits to the base station can be analyzed for the measurement parameters defined in the IS-95 and T-53 standards. The analysis items are listed in Table 3–14.

Table 3–14: CDMA analysis items

Classification	Analysis items	Remark
Channel analysis (Evaluation of demodulation precision and waveform quality)	In-band power Burst waveform F error EVM and Rho (ρ)	5 MHz span
In-band analysis (Evaluation of spurious)	Spurious (30 kHz and 1 MHz RBW) OBW	30 MHz or 5 MHz
Time characteristic analysis (Evaluation of rising and falling characteristics)	Power Specified Line Average power Rising and falling edges	1.6 ms wide 25 μ s wide

This section describes each type of analysis.

Evaluation of Demodulation Precision and Waveform Quality

Figure 3–59 shows the result of a channel analysis performed in the four views with the **EVM/Rho** basic configuration.

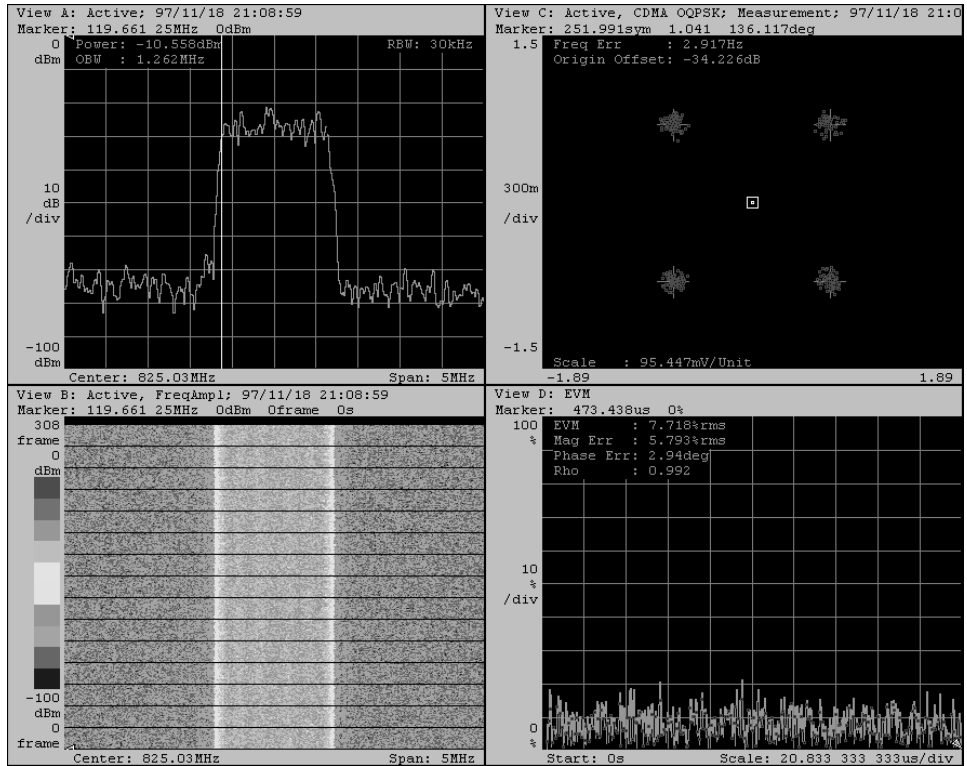

Figure 3–59: CDMA analysis with the EVM/Rho basic configuration

View Contents

View A — Shows the plot of the in-band power values within the specified RBW (resolution bandwidth) using the CDMAWaveform view. Power (in-band power) and OBW (occupied bandwidth) are displayed at the top left corner of the view. The RBW value is preset to 30 kHz. If necessary, it can be switched to 1 MHz.

Refer to *Power Measurement* on page 3–81 for detail on the definitions of Power and OBW. Note that the CDMA analysis uses the measurement parameters defined in the IS-95 and T-53 standards.

View B — Displays the Spectrogram view to confirm the signal acquisition status.

View C — Displays the frequency and origin offset errors using the CDMAPolar view while demodulating the input signal. This view also displays the symbol positions with red points and the symbol-to-symbol trace in the vector display.

Refer to *Process Flow* on page 3–98 for the demodulation function.

View D — After compensating the origin offset from the signal demodulated in the CDMAPolar view, View D displays the following modulation quality information at the top left corner of the view using the EVM view.

- EVM (% RMS): Root-mean-square of EVM (error vector magnitude)
- Mag Error (% RMS): Root-mean-square of amplitude error
- Phase Error (deg): Root-mean-square of phase error
- Rho: ρ meter

The IS-95 and T-53 standards specify that the ρ meter value shall be 0.995 or larger. Refer to *Error Vector Analysis Display* on page 3–106 for details of the above information.

The green trace represents the EVM between the ideal and measured signals. The red points represent symbols of the measured signal. The display can be switched to Mag Error or Phase Error.

Measurement Procedure

1. Press **CONFIG:MODE** → **More...** → **CDMA (IS-95/T-53)** and select **EVM/Rho** to set the analyzer with the basic configuration.
2. Press the **SETUP:MAIN** key.
3. Select the channel as necessary.

- a. Press the **Freq, Span, Ref...** side key.
- b. Press the **Standard** side key to select IS-95 or T53.
- c. Press the **Channel** side key to select or type the channel number.

For IS-95, you can select 1 to 777 for the channel number. Channels 1 and 7 correspond to 825.03 and 848.31 MHz, respectively. The frequency difference between two adjacent channels is 0.03 MHz.

For T-53, you can select 1 to 1199 for the channel number. Channels 1 and 7 correspond to 915.0125 and 888.9875 MHz, respectively. The frequency difference between two adjacent channels is 0.0125 MHz.

- d. Press the **[Setup]<** side key (top side key) to return to the previous menu level.
4. Select the relationship between the span and the trigger:

For a continuous input signal, press the **5M Span Auto Trig.** side key.
For a burst input signal, press the **5M Span Normal Trig.** side key.

If you select **5M Span Normal Trig.** although the input signal is continuous, the measurement may be disabled because no trigger can be generated. If you do not know whether a continuous or burst signal is input, first select **5M Span Auto Trig.** If the display condition is unstable, select **5M Span Normal Trig.** because a burst signal is a high probability.

5. Press the **BLOCK** key to initiate the measurement.

The signal is displayed in each view together with the measurement values.

Setting RBW to 1 MHz. Measure Power and OBW with View A at a resolution bandwidth (RBW) of 1 MHz.

1. Press the key **VIEW:A** → **VIEW:MAIN**.
2. Press the side key **RBW...** → **RBW** and select **1M**.

Switching the error display to Mag or Phase Error. Switch the error display in View D to Mag Error or Phase Error:

1. Press the key **VIEW:D** → **VIEW:MAIN**.
2. Press the **Format** side key to select either **Mag Error** or **Phase Error**.
3. If necessary, press the side key **Options...** → **Scale, Marker, Search...** → **Scale...** → **Auto Scale** to adjust the scale.

Evaluation of Spurious

Figure 3–60 shows the two views that display the in-band analysis results with the **Spurious** basic configuration.

Examine the spurious of the external area.

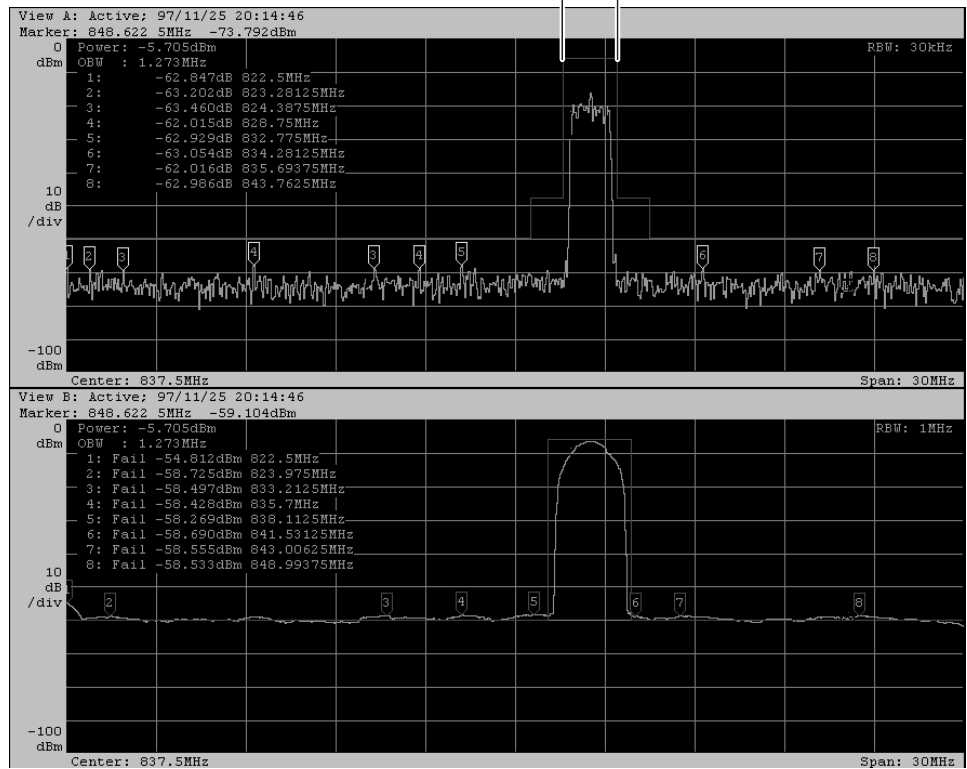

Figure 3–60: CDMA analysis with the Spurious basic configuration (30 MHz span)

View Contents

Views A and B use the CDMAWaveform view. By default, the two views show the same results with the same settings. In Figure 3–60, the RBW for View B is set to 1 MHz.

With the RBW (resolution bandwidth) set to 30 kHz or 1 MHz, the in-band power values are calculated from the input signal. The waveform displayed in the view is created by plotting these values in each frequency position. The red line is the Specified Line from IS-95 and T-53. The displayed spectrum must be inside this line. When you set the RBW menu item to Off, the input signal itself is displayed but the Specified Line disappears.

The Power (in-band power) and OBW (occupied bandwidth) values for the input signal are listed at the top left corner of the view. Refer to *Power Measurement* on page 3–81 for detail about the definitions of Power and OBW.

Each number enclosed in yellow lines, called a number tag, indicates a spurious signal position. The eight strongest spurious signals can be selected and numbered in frequency or level order. The selection is made by searching the signals outside the red base line with the strongest area (see Figure 3–60). Information about each spurious signal having the number tag is displayed in each view in the following format:

```
Number: Fail information  signal-intensity (dB or dBm)
frequency-position
```

The Number corresponds to the number of the number tag. If a spurious signal is beyond the Specified Line, Fail is displayed. Otherwise, empty display results.

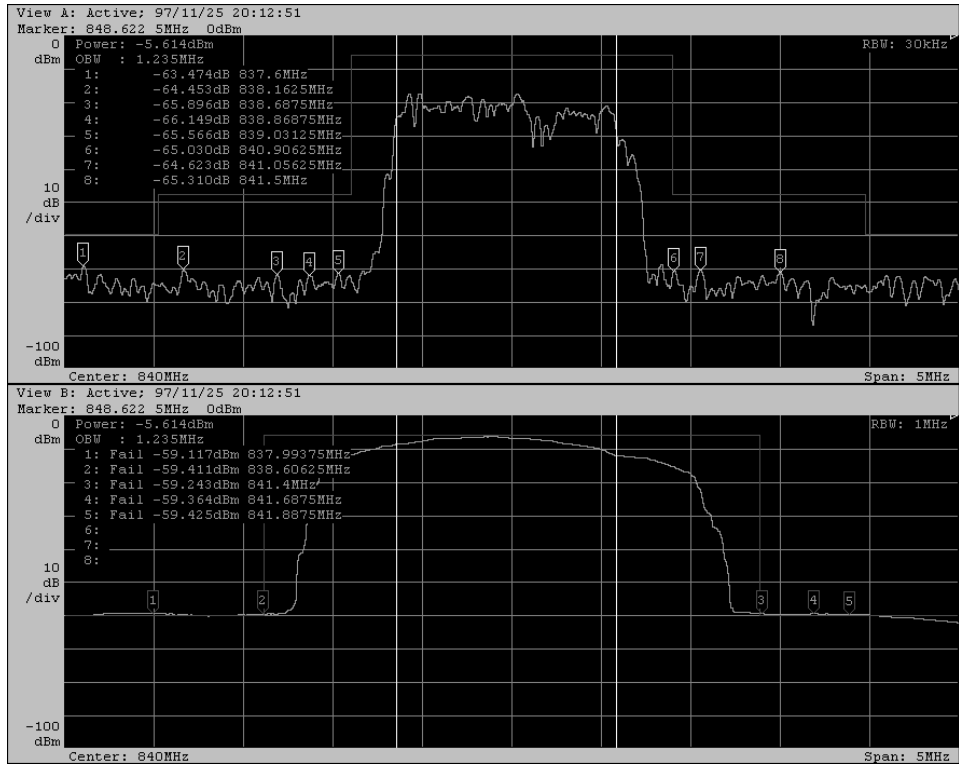

Figure 3-61: CDMA analysis with the Spurious basic configuration (5 MHz span)

Specified Line Settings

By default, the specified lines are set as shown in Figures 3–62 and 3–63. The values agree with those specified in the IS-95 and T-53 standards. You can view and set the specified line parameters by selecting **Options...**→**Mask...** in the CDMAWaveform view menu.

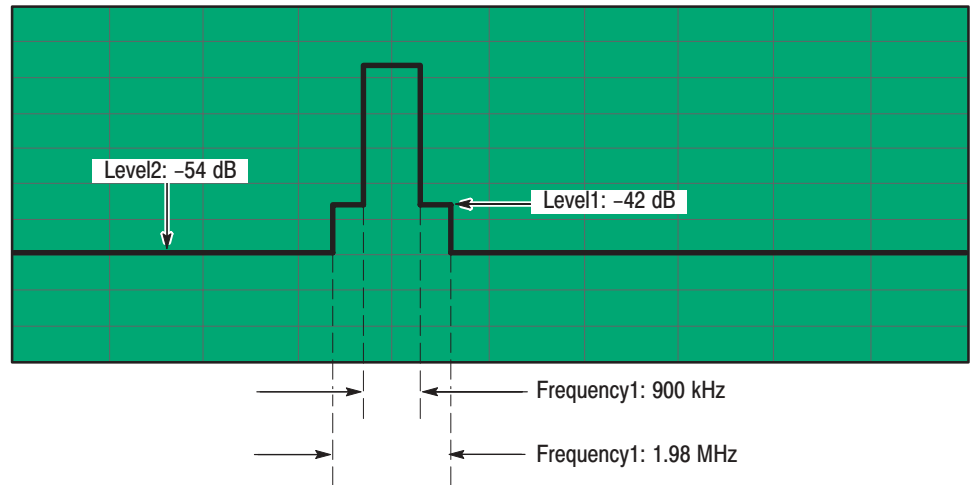

Figure 3–62: Default specified line (when RBW = 30 k)

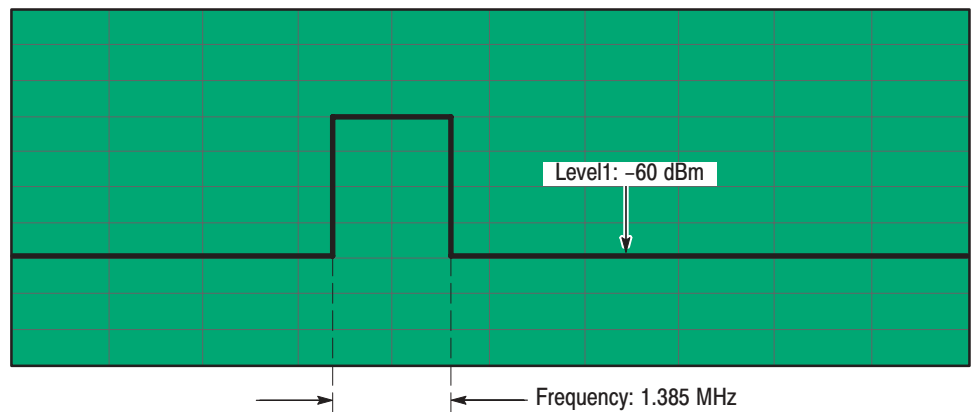

Figure 3–63: Default specified line (when RBW = 1 M)

Measurement Procedure

1. Press CONFIG:MODE → More... → CDMA (IS-95/T-53) and select **Spurious** to set the analyzer with the basic configuration.
2. Press the SETUP:MAIN key.
3. Select the channel as necessary.

- a. Press the **Freq, Span, Ref...** side key.
- b. Press the **Standard** side key to select IS-95 or T53.
- c. Press the **Channel** side key to select or type the channel number.

For IS-95, you can select 1 to 777 for the channel number. Channels 1 and 777 correspond to 825.03 and 848.31 MHz, respectively. The difference in frequency between channels is 0.03 MHz.

For T-53, you can select 1 to 1199 for the channel number. Channels 1 and 7 correspond to 915.0125 and 888.9875 MHz, respectively. The frequency difference between two adjacent channels is 0.0125 MHz.

- d. Press the [Setup]<– side key (top side key) to return to the previous menu level.
4. Select the combination of span and trigger: Press the side key **30M Span**, **5M Span Auto Trig.**, or **5M Span Normal Trig.**
 - Select **30M Span** when observing spurious signals in a wide range. The Auto trigger setting is selected automatically. The Block mode is not available to acquire a signal in this setting.
 - For 5MHz span, the Block mode is available.
For a continuous input signal, select **5M Span Auto Trig.**
For a burst input signal, select **5M Span Normal Trig.**

When the **5M Span Normal Trig.** is selected, the measurement may not be performed because a trigger event can not be generated. If you do not know whether a continuous or burst signal is input, select **5M Span Auto Trig.** first. If the display is unstable, select **5M Span Normal Trig.** because it is likely a burst signal.

5. Perform the measurement by pressing the **ROLL** key if **30M Span** or by pressing the **BLOCK** key if **5M Span**.

Changing the resolution bandwidth. You can select the resolution bandwidth (RBW). If you set it to **Off**, the usual spectrum is displayed.

1. Press the **RBW** side key and select the resolution bandwidth or **Off**.
2. Press the **BLOCK** key to start the measurement.

Sorting the number tags in frequency order. The number tags default to be numbered in spurious strength order. They can be renumbered in frequency order.

1. Press **Measurement Options...** → **Sorted by** and select **Frequency**.
2. Perform the measurement by pressing the **ROLL** key if **30M Span** or by pressing the **BLOCK** key if **5M Span**.

Performing the measurement with the number tag display fixed. By default, the spurious signals are searched and the number tags are updated each time the measurement is performed. With the number tag display fixed, you can evaluate time-dependent changes of the spurious.

1. Press **Measurement Options...** → **Spurious Search** and select **Off**.
2. Perform the measurement by pressing the **ROLL** key if **30M Span** or by pressing the **BLOCK** key if **5M Span**.

Time Characteristic Evaluation

Figure 3–64 shows the two views that display the in-band analysis result with the **Time Domain** basic configuration.

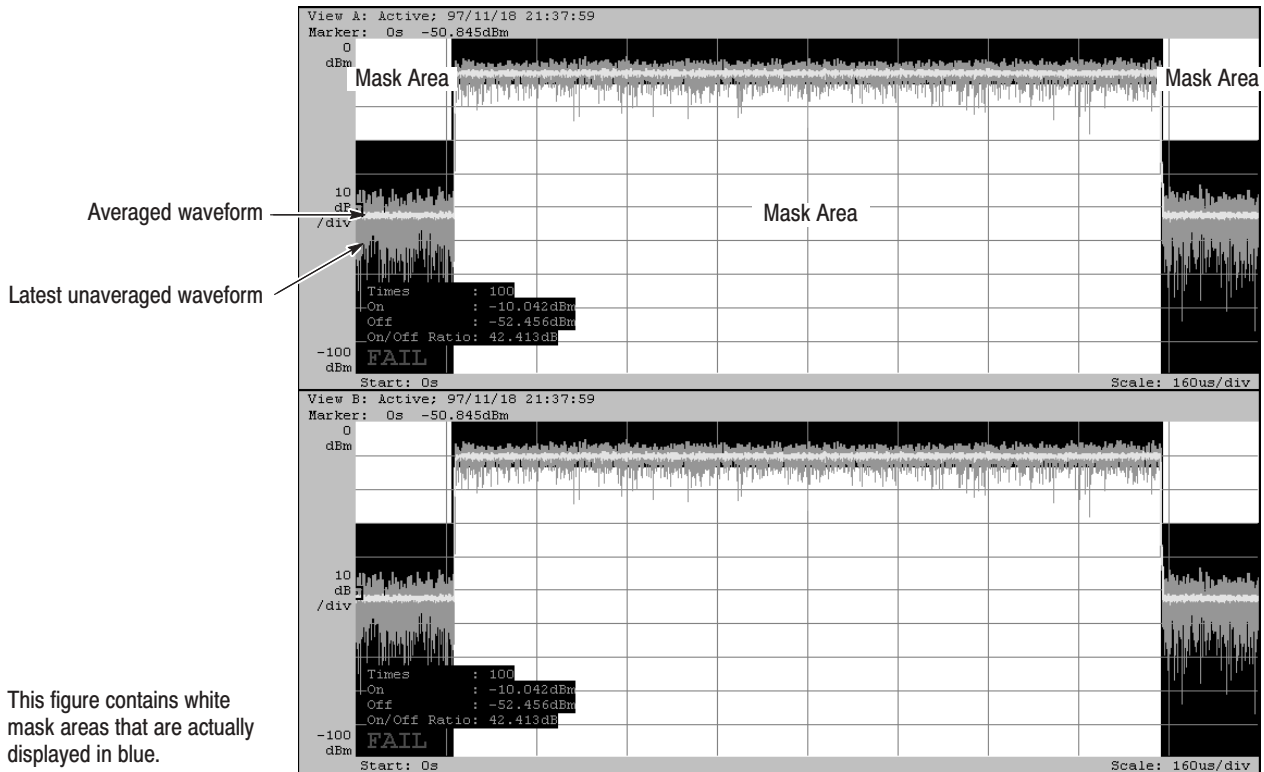

Figure 3–64: CDMA analysis with the Time Domain basic configuration

View Contents

Views A and B use the CDMA Time view showing signal strength along the vertical axis and time shown on the horizontal axis. By default, the two views display the same contents. They are used to measure the burst signal rising and falling time characteristics according to the IS-95 and T-53 standards.

The green waveform is obtained by one scan, while the yellow one is the average of 100 scans. When an averaged signal enters a mask area that is blue, this results in an error. FAIL is displayed in red at the bottom left corner of the view.

The following information is also shown at the bottom left corner of the view:

Times	Averaging count
On	Burst signal intensity (averaged waveform)
Off	Intensity resulting when the burst signal is off (averaged waveform)
On/Off Ratio	Ratio of the signal strength resulting when the burst signal is on, to that resulting when off.

Mask Settings

By default, the mask area is set as shown in Figure 3–65. These values are specified in IS-95 and T-53. You can view and set the mask parameters by selecting **Options... → Mask...** in the CDMA Time view menu.

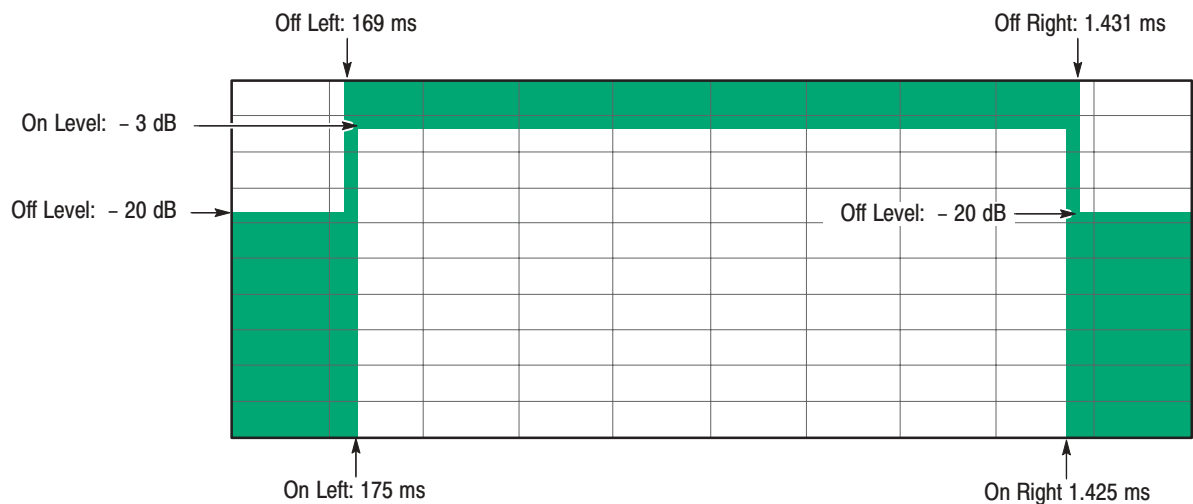

Figure 3–65: Default mask area

Measurement Procedure

1. Press **CONFIG:MODE** → **More...** → **CDMA (IS-95/T-53)** and select **Time Domain** to set the analyzer with the basic configuration.
2. Press the **ROLL** key to make sure that the input signal is a burst.

NOTE. *The burst signal must be active to evaluate the rising and falling characteristics of the input signal.*

3. Press the **Measure** side key to perform the measurement.

When you press the **Measure** side key, the [nnn/100] message appears. By default, nnn increases from 0 to 100. It indicates that the signal is acquired 100 times while being averaged. After the [100/100] message appears, the view displays the latest acquisition signal in green and the averaged waveform in yellow. At the same time, the averaged waveform is compared with the mask for the PASS/FAIL test. The result is shown at the bottom left corner of the view.

IS-95 specifies that the averaging count is 100. This value is the default for the analyzer. You can set another value through **Options...** → **Num Averages** in the view menu.

To stop the measurement before completion, press the **Break** side key or **CLEAR** front-panel key.

Analyzing rising and falling characteristics in detail. The rising and falling characteristics are critical to the time characteristic measurement. Figure 3–66 shows the rising and falling waveforms enlarged in two of the four views.

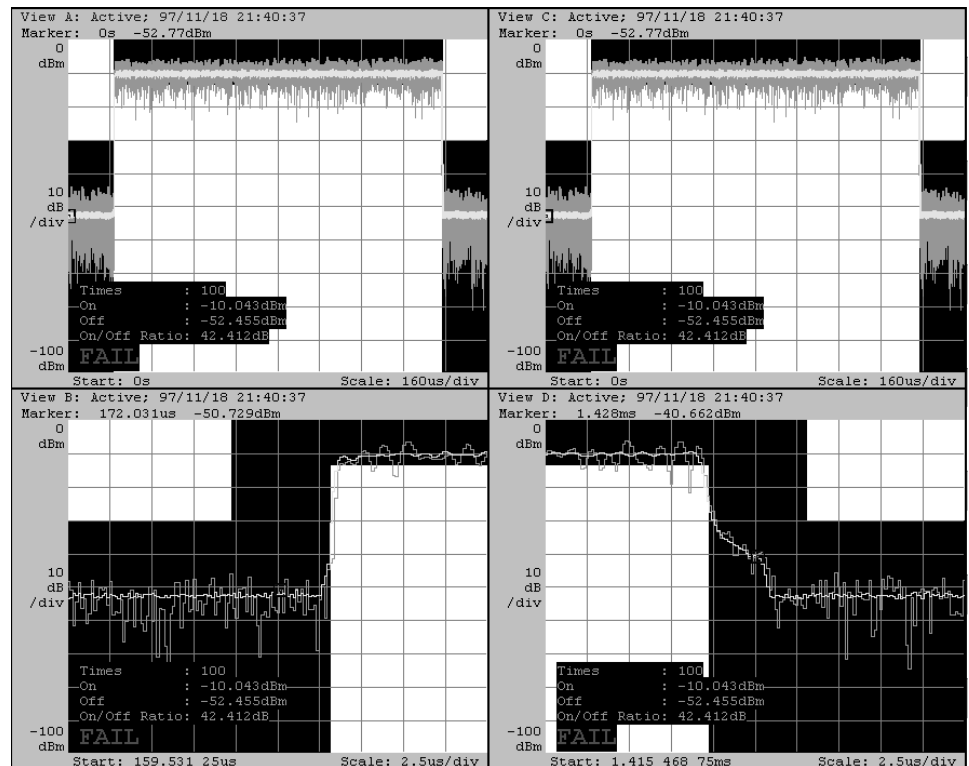

Figure 3–66: Analyzing rising and falling characteristics in detail

1. Press the CONFIG:VIEW key.
2. Select **CDMATime** for Views C and D.
Now, the four views contain the same display.
3. Change the View B display:
 - a. Press the key VIEW:B → VIEW:MAIN.
 - b. Press the side key **Option...** → **Scale, Marker, Search...** → **Scale...** → **Rising Edge**.

4. Change the View D display:
 - a. Press the key **VIEW:D** → **VIEW:MAIN**.
 - b. Press the side key **Option...** → **Scale, Marker, Search...** → **Scale...** → **Falling Edge**.

View B and D change as shown in lower part of Figure 3–66.

cdmaOne Analysis

This chapter describes the cdmaOne analysis functions. The following topics are discussed.

- About the cdmaOne analysis
- Operating examples
 - Standard code-domain power measurement
 - Code-domain power measurement for continuous symbols

About cdmaOne Analysis

The analyzer processes the cdmaOne down-link signals specified in “TIA/EIA IS-95-A” (1995.5 TIA/EIA). The function covers the cdmaOne parameters listed in Table 3–15.

Table 3–15: cdmaOne parameters

Item	Description
Chip rate	1.2288 Mcps
Symbol rate	19.2 ksps
Number of channels	64
Spreading code	Pilot PN code
Orthogonal code	Walsh
Modulation method	QPSK
Foward link filter	IS-95 or IS-95 plus equalizer

Measurement Functions

The analyzer has the following cdmaOne measurement functions.

- *Code-domain power*
The analyzer measures the relative power to total power for each channel.
- *Code-domain power spectrogram*
The analyzer measures the code-domain power continuously for 6144 symbols (0.32 s) maximum and displays spectrogram for each symbol.
- *Vector/constellation*
The analyzer measures vector loci and chip points for all signals.
- *Modulation accuracy*
The analyzer measures EVM (error vector magnitude), amplitude error, phase error, waveform quality, and origin offset for all signals.

Measurement Process

The analyzer processes the input signals internally with the following procedure.

1. Perform the flatness correction and filtering.
2. Establish the synchronization as QPSK and correct the frequency and phase.
3. Establish the long-code using pilot channels.
4. Perform Fast Hadamard Transformation.
5. Calculate the symbol power for all channels.
6. Create the reference waveform.

Operating Examples

This section shows two typical operation examples: standard code-domain power measurement and code-domain power measurement for continuous symbols.

Standard Code-Domain Power Measurement

The following is the basic procedure for standard code-domain power measurement.

1. Press the CONFIG:**MODE** key.
2. Press the **More...** side key.
3. Press the **cdmaOne Fwd Link** side key.

The default views are displayed as follows (see Figure 3–67 to 3–69):

View A: Spectrum (Waveform view)

View B: Code-domain power spectrogram (CodeSpectrogram view)

View C: Vector diagram (CodePolar view)

View D: Code-domain power (CodePower view)

4. Press the SETUP:**FREQ** key to set the center frequency.
5. Press the SETUP:**REF** key to set the reference level.
6. Press the START/STOP:**ROLL** key to start data acquisition.

When the input level is too high, the OVERLOAD indicator displays in red. Then, increase the reference level.

The measurement for each symbol continues. To stop data acquisition, press START/STOP:**ROLL** key again

For details on the view menus, refer to page 2–63 and below.

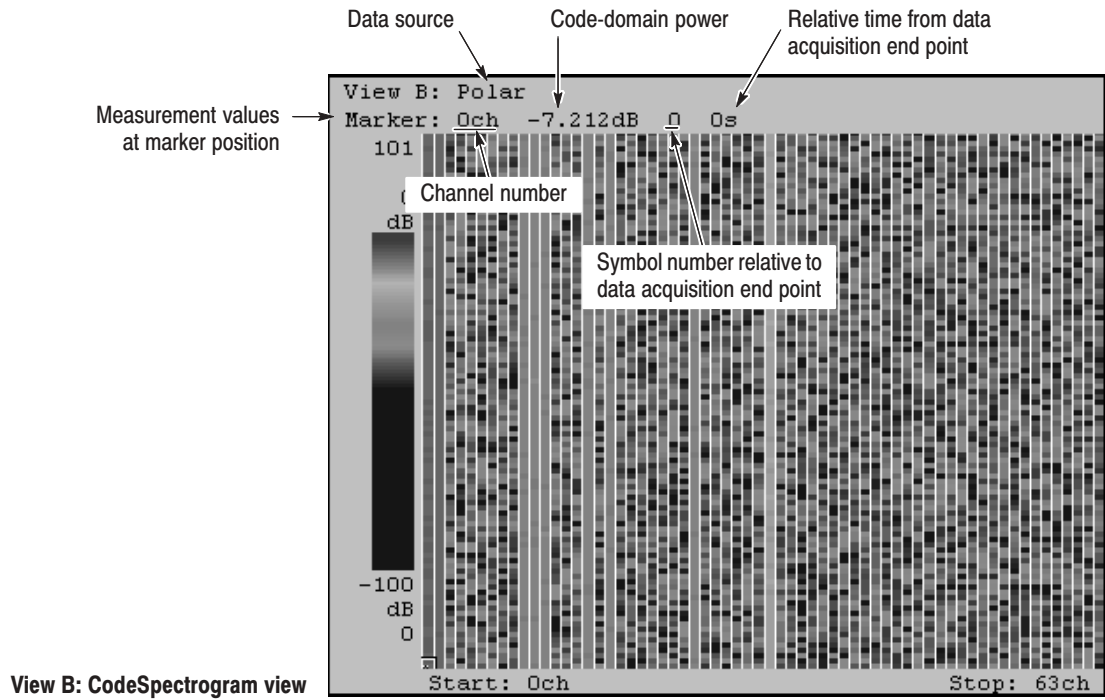

Figure 3-67: Code-domain power spectrogram

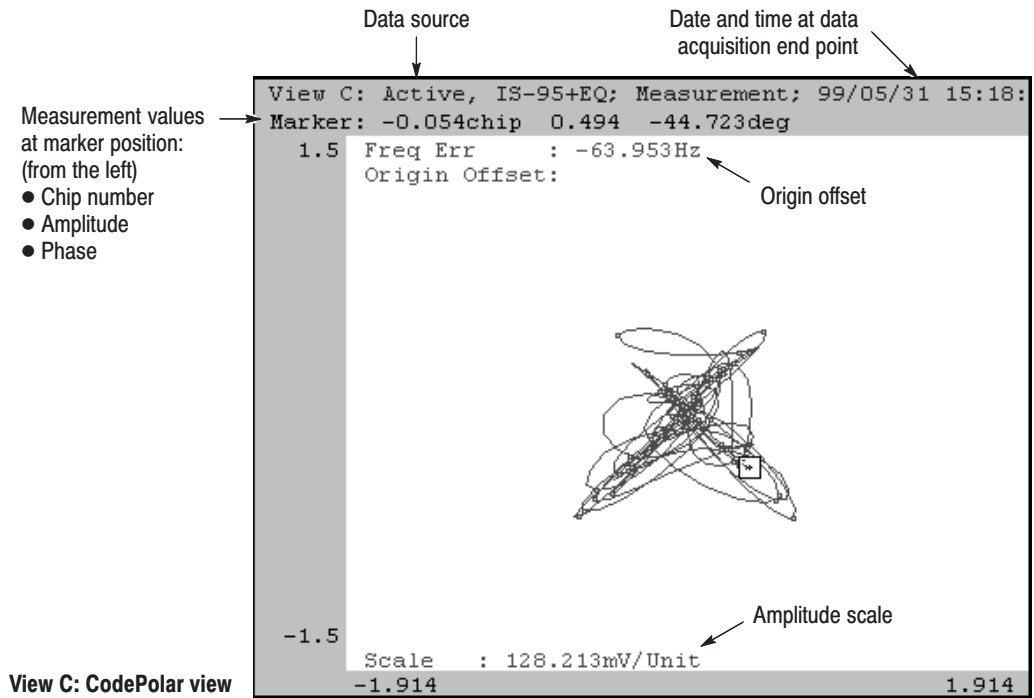

Figure 3-68: Constellation

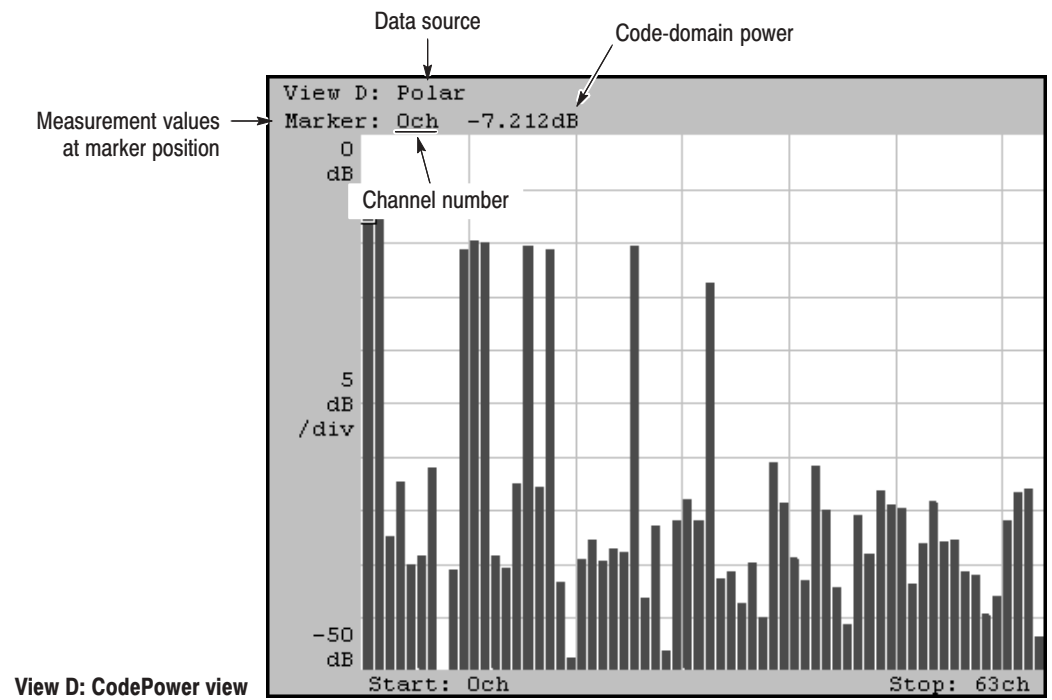

Figure 3-69: Code-domain power

Code-Domain Power Measurement for Continuous Symbols

The standard code-domain power measurement, as described above, acquires and processes frames one-by-one, so it can not capture symbols continuously because of the process time limit. The following shows the method to obtain continuous code-domain power by acquiring data for symbols in the lump and performing the measurement for continuous data.

1. Press the CONFIG:MODE key.
2. Press the **More...** side key.
3. Press the **cdmaOne Fwd Link** side key.
4. Press the SETUP:FREQ key to set the center frequency.
5. Press the SETUP:REF key to set the reference level.
6. Press the SETUP:MAIN key.
7. Press the **Block Size** side key and enter the number of frames. The number of frames M must satisfy the following condition to analyze N symbols:

$$M > 0.33 \times N$$

8. Press the START/STOP:BLOCK key to start data acquisition.
After the data acquisition, the first symbol is analyzed.
9. Press the VIEW:C key.
10. Press the **Analyze** side key to analyze for all frames.

Example. Figure 3–70 shows an example of continuous symbol analysis. In this example, the analyzer has captured the phenomenon that the signal power is decreasing gradually, using the trigger functions (refer to *Trigger* on page 3–65 for using trigger functions). The movement of the marker along the time axis in View B links to the display of code-domain power in View A and D. So you can observe the time-varying signal with consistency between the frequency domain and code domain.

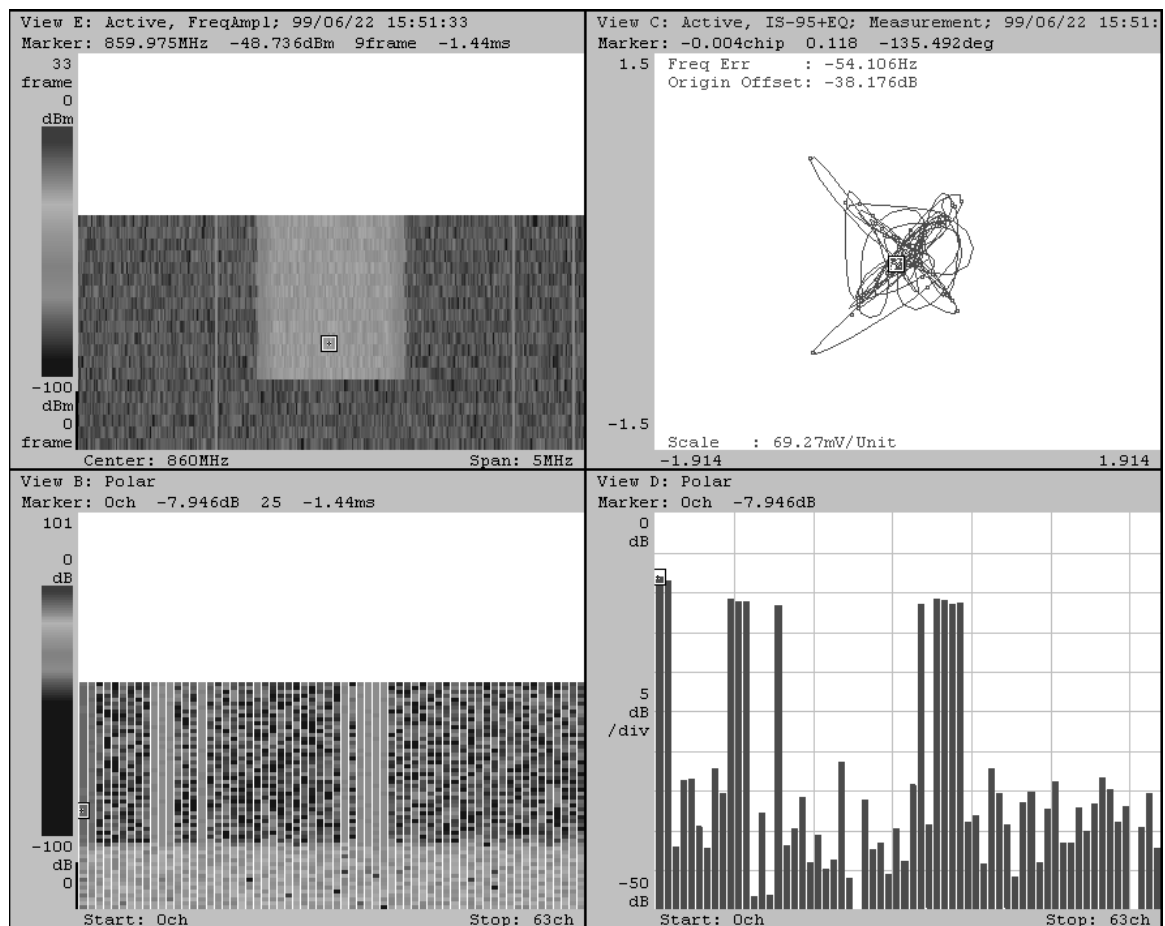

Figure 3–70: Analyzing a transient signal

W-CDMA Analysis

This chapter describes the W-CDMA (Wideband CDMA) analysis functions.

The following topics are discussed in this chapter.

- About the W-CDMA analysis
- Operating examples
 - Standard code-domain power measurement
 - Code-domain power measurement for continuous slots

About W-CDMA Analysis

The analyzer processes the W-CDMA down-link signals specified in “Specifications for W-CDMA Mobile Communication System Experiment Version 1.1” (1998.3 NTT Mobile Communications Network Inc.). The analyzer covers the W-CDMA parameters listed in Table 3–16.

Table 3–16: W-CDMA parameters

Item	Description
Chip rate	4.096 Mcps, 8.192 Mcps, 16.384 Mcps
Symbol rate	16 ksps, 32 ksps, 64 ksps, 128 ksps, 256 ksps, 512 ksps, 1024 ksps
Number of channels (maximum)	256 (4.096 Mcps), 512 (8.192 Mcps), 1024 (16.384 Mcps)
Frame structure	Time slot: 625 μ s
Long code	18-bit Gold code using M-sequence obtained from the generator polynomial
Short code	Hierarchical orthogonal code sequence specified with the combination of the chip rate and symbol rate
Short code in a long code mask (LMS) part	8-bit Gold code using M-sequence obtained from the generator polynomial
Modulation method	QPSK
Baseband filter	Root-cosine with $\alpha=0.22$ (default); $0.0001 \leq \alpha \leq 1$

Measurement Functions

The analyzer has the following measurement functions.

- *Code-domain power*
The analyzer measures the relative power to total power for each channel with multi-rate and 1024 channels maximum.
- *Time vs. code-domain power*
The analyzer measures the relative power at symbol points for each channel as time series.
- *Code-domain power spectrogram*
The analyzer measures the code-domain power continuously for maximum 160 slots (0.1 s) and displays spectrogram for each slot.
- *Vector/constellation*
The analyzer measures the vector loci and chip points for entire signals, as well as constellation at symbol points for each channel.
- *Modulation accuracy*
The analyzer measures EVM (error vector magnitude), amplitude error, phase error, waveform quality, and origin offset for each channel.

Measurement Process

The analyzer processes the input signals internally with the following procedure:

1. Perform the flatness correction and filtering.
2. Establish the synchronization with LMS of the 1st perch channel.
3. Determine the long-code number range at the 2nd perch channel.
4. Establish the long-code number and phase.
5. Correct the frequency and phase.
6. Perform Fast Hadamard Transformation.
7. Calculate the symbol power for all channels.
8. Extract effective channels from pilot symbols.

Operating Examples

Standard Code-Domain Power Measurement

The following is the basic procedure for standard code-domain power analysis.

1. Press the CONFIG:**MODE** key.
2. Press the **More...** side key.
3. Press the **W-CDMA Down Link** side key.

The default views are as follows (see Figure 3–71 to 3–74):

View A: Spectrum (Waveform view)

View B: Code-domain power spectrogram (CodeWSpectrogram view)

View C: Vector diagram (CodeWPolar view)

View D: Code-domain power (CodeWPower view)

4. Press the VIEW:**C** key.
5. Press the **Standard...** side key and select chip rate: 4.096, 8.192, or 16.384 Mcpc.
6. Press the SETUP:**SPAN** key and set the span as follows:
 - Span 10 MHz for the chip rate of 4.096 Mcpc
 - Span 30 MHz for the chip rate of 8.192 and 16.384 Mcpc
7. Press the SETUP:**FREQ** key to set the center frequency.
8. Press the SETUP:**REF** key to set the reference level.
9. Press the START/STOP:**BLOCK** key to acquire one block of data.

When the input level is too high, the OVERLOAD indicator displays in red. Then, increase the reference level.

For details on the view menus, refer to page 2–63 and below.

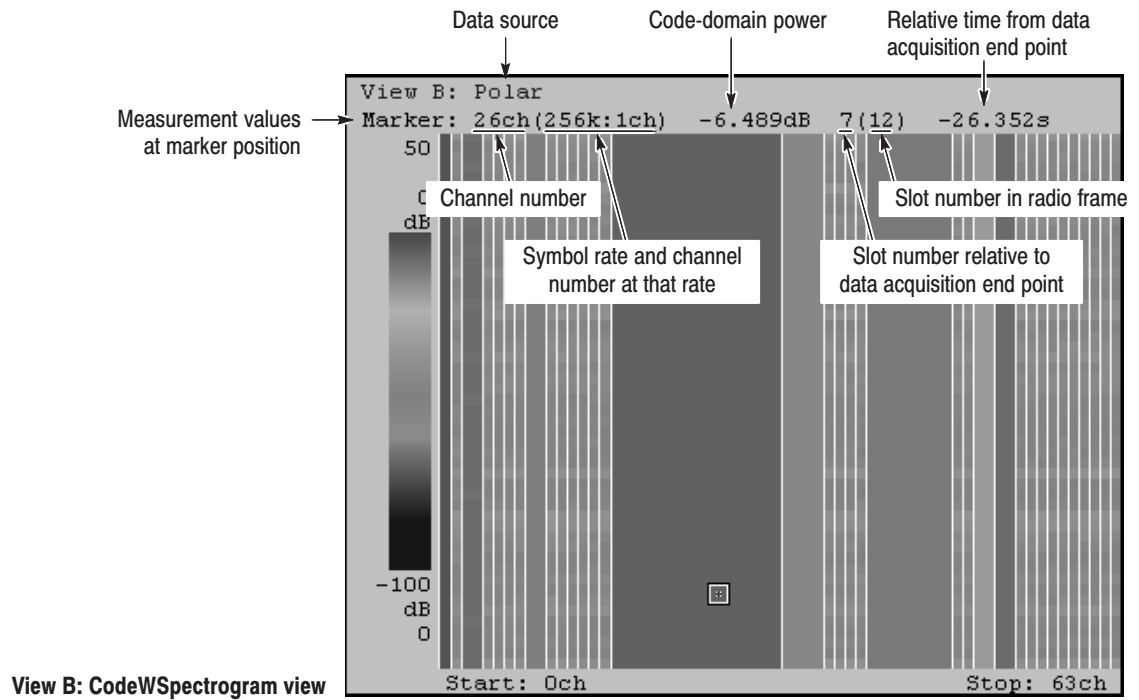

Figure 3-71: Code-domain power spectrogram

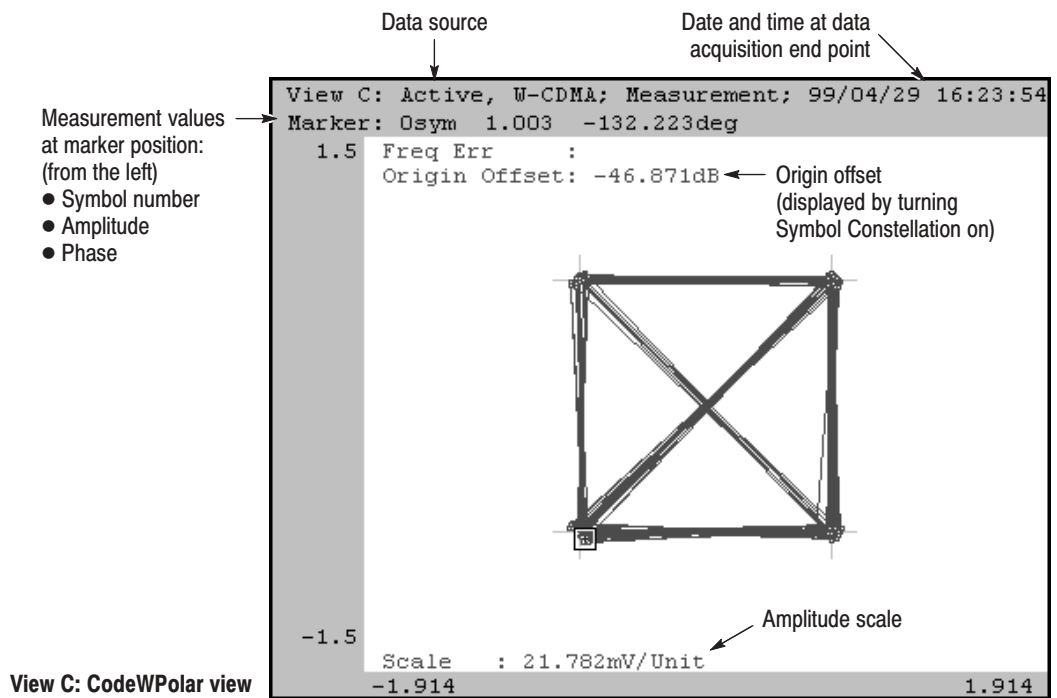

Figure 3-72: Symbol constellation

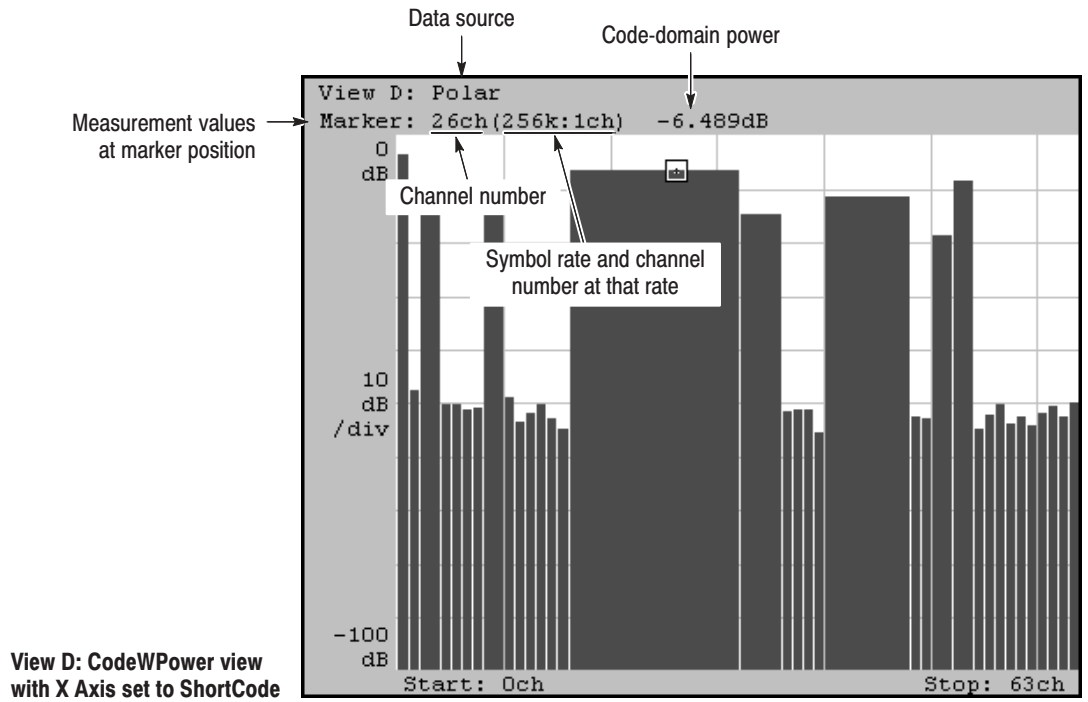

Figure 3-73: Code-domain power

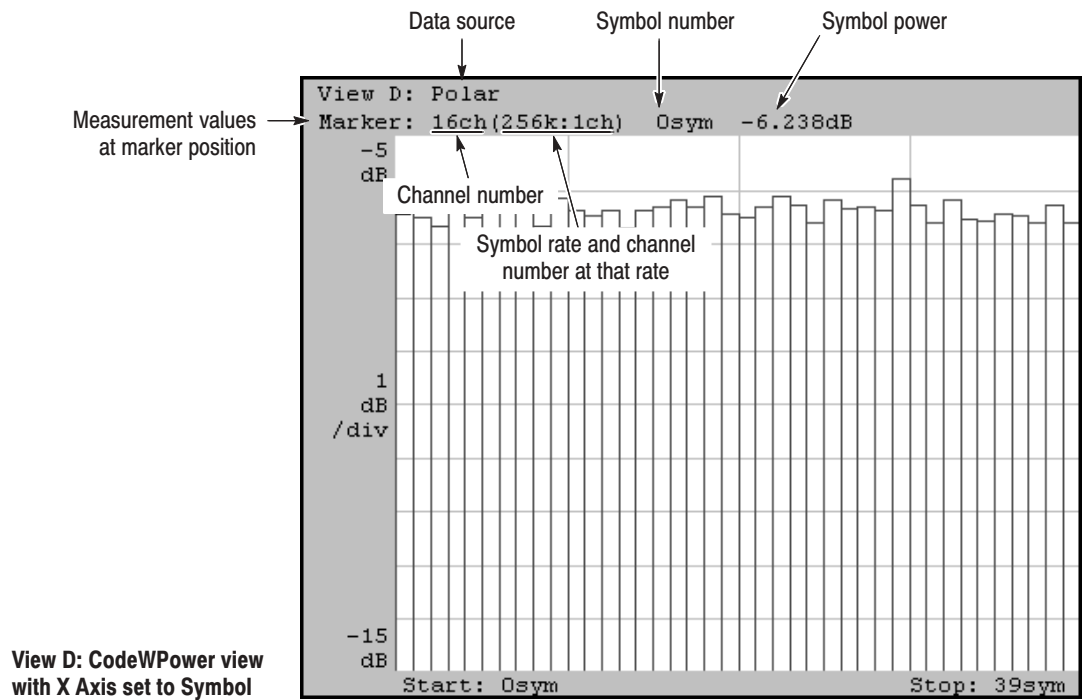

Figure 3-74: Symbol power

Code-Domain Power Measurement for Continuous Slots

The standard code-domain power measurement, as described above, acquires and processes slots one-by-one, so it can not capture slots continuously because of the process time limit. The following shows the method to obtain continuous code-domain power by acquiring data for slots in the lump and performing the measurement for continuous data.

1. Press the **CONFIG:MODE** key.
2. Press the **More...** side key.
3. Press the **W-CDMA Down Link** side key.
4. Press the **VIEW:C** key.
5. Press the **Standard...** side key and select chip rate: 4.096, 8.192, or 16.384 Mcpc.
6. Press the **SETUP:SPAN** key and set the span as follows:
 - Span 10 MHz for the chip rate of 4.096 Mcpc
 - Span 30 MHz for the chip rate of 8.192 and 16.384 Mcpc
7. Press the **SETUP:FREQ** key to set the center frequency.
8. Press the **SETUP:REF** key to set the reference level.
9. Press the **SETUP:MAIN** key.
10. Press the **Block Size** side key and set the number of frames. The number of frames M must satisfy the following condition to analyze N slots:
$$M > K(N + 1.5)$$
where K=12.5 for 10 MHz span, K=25 for 20 or 30 MHz span.
11. Press the **Trigger...** side key.
12. Set the **Count** side key to **On**.
13. Press the **START/STOP:BLOCK** key to start data acquisition.

After the data acquisition, the first slot is analyzed.
14. Press the **VIEW:C** key.
15. Press the **Analyze** side key to analyze for all frames.

Example. Figure 3–75 shows an example of continuous slot analysis. In this example, the analyzer has captured the phenomenon that the signal power is decreasing gradually, using the trigger functions (refer to *Trigger* on page 3–65 for using trigger functions). The movement of the marker along the time axis in View B links to the display of code-domain power in View A and D. So you can observe the time-varying signals with consistency between the frequency domain and code domain.

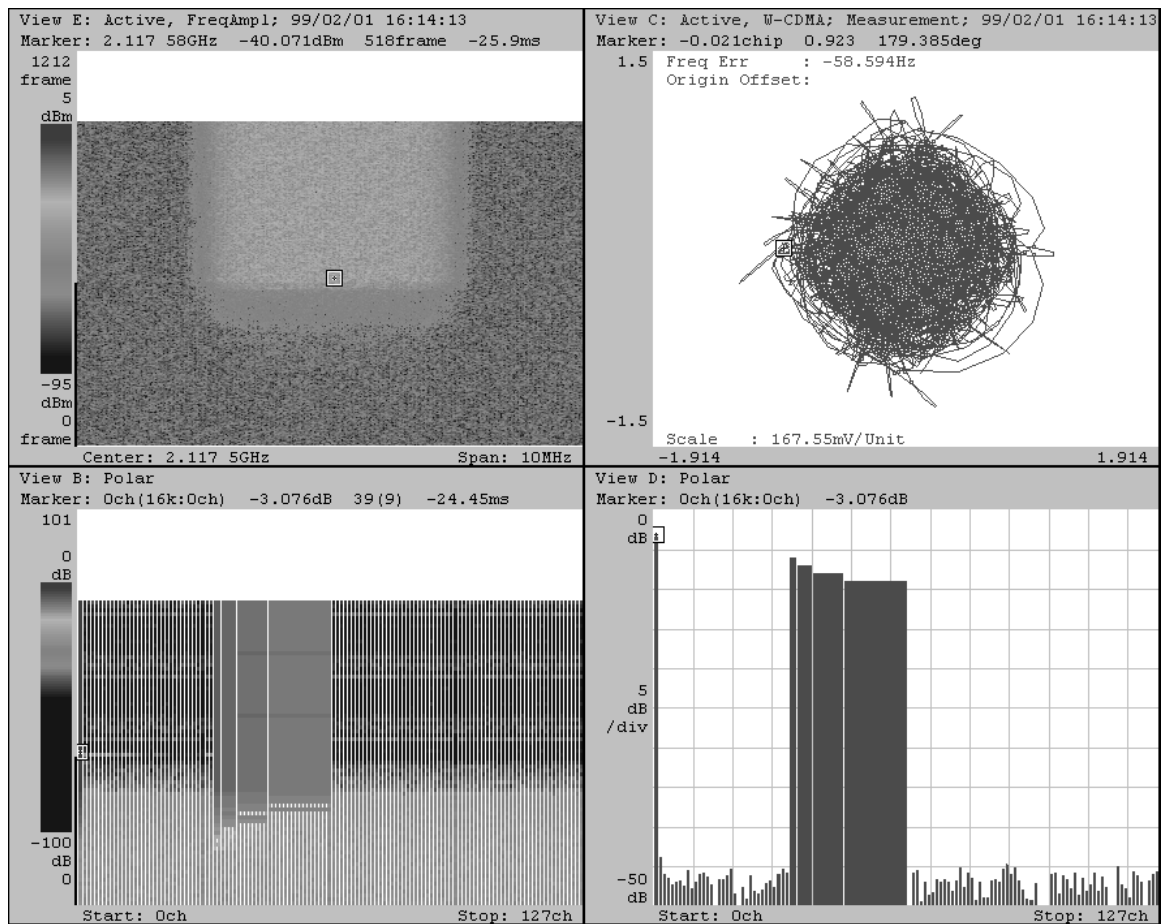

Figure 3–75: Analyzing a transient signal

3GPP Analysis

This chapter describes down-link signal analysis and ACP (Adjacent Channel Leakage Power) measurement under the 3GPP (3rd Generation Partnership Project) standard.

The following topics are discussed in this chapter.

- 3GPP down-link signal analysis
 - About the 3GPP analysis
 - Measurement functions
 - Measurement process
 - Basic operation for code-domain power measurement
- 3GPP ACP measurement
 - Restrictions
 - Basic procedure

3GPP Down-Link Signal Analysis

About the 3GPP Analysis

The analyzer processes the down-link signals specified in the 3GPP standard. The analyzer covers the 3GPP parameters listed in Table 3–17.

Table 3–17: 3GPP parameters

Item	Description
Chip rate	3.84 Mcps
Symbol rate	7.5 ksps, 15 ksps, 30 ksps, 60 ksps, 120 ksps, 240 ksps, 480 ksps, 960 ksps, 1920 ksps
Maximum number of channels	512
Frame structure	Time slot: 666.7 μ s
Scrambling code	18-bit Gold code using M-sequence obtained from the generator polynomial
Channelization code	Hierarchical orthogonal code sequence specified with the combination of the chip rate and symbol rate
Modulation method	QPSK
Baseband filter	Root-cosine with $\alpha=0.22$ (default); $0.0001 \leq \alpha \leq 1$

Measurement Functions

The analyzer has the following measurement functions.

- *Code-domain power*
The analyzer measures the relative power to total power for each channel with multi-rate and 512 channels maximum.
- *Time vs. code-domain power*
The analyzer measures the relative power at symbol points for each channel as time series.
- *Code-domain power spectrogram*
The analyzer measures the code-domain power continuously for maximum 150 slots (0.1 s) and displays spectrogram for each slot.
- *Vector/constellation*
The analyzer measures the vector loci and chip points for entire signals, as well as constellation at symbol points for each channel.
- *Modulation accuracy*
The analyzer measures EVM (error vector magnitude), amplitude error, phase error, waveform quality, and origin offset for each channel.

Measurement Process

The analyzer processes the input signals internally using the following procedure:

1. Perform the flatness correction and filtering.
2. Establish the synchronization with P-SCH.
3. Determine the scrambling code number range with S-SCH.
4. Establish the long-code number and phase.
5. Correct the frequency and phase with PCPICH.
6. Perform Fast Hadamard Transformation.
7. Calculate the symbol power for all channels.

Basic Operation for Code-Domain Power Measurement

The following is a basic procedure for standard code-domain power analysis. The analyzer acquires a number of slots and performs the measurement for continuous data.

1. Press the CONFIG:**MODE** key on the front panel.
2. Press the side key **More...** → **3GPP...** → **Down Link** to configure the analyzer for the 3GPP down-link signal analysis.

Default views are as follows:

View A: Spectrum (Waveform view)

View B: Code-domain power spectrogram (3gppSpectrogram view)

View C: Vector diagram (3gppPolar view)

View D: Code-domain power (3gppPower view)

For details on the view menus, refer to *Menu Functions* beginning on page 2–47 and the illustrations on pages 3–147 and 3–148.

3. Press the SETUP:**FREQ** key and set the center frequency.
4. Press the SETUP:**REF** key and set the reference level.
5. Press the SETUP:**MAIN** key.
6. Press the **Block Size** side key and set the number of frames. The number of frames M must satisfy the following condition to analyze N slots:

$$M > K (N + 1.5) \quad \text{where } K=13.4$$

7. Press the START/STOP:**BLOCK** key to start data acquisition.

After the data acquisition, the first slot is analyzed.

When the input level is too high, the OVERLOAD indicator displays in red. Then, increase the reference level.

8. Press the VIEW:**C** key.
9. Press the **Analyze** side key to measure for all frames.

10. A low level signal may cause an irregular waveform display. In this case, try these steps:

NOTE. *The analyzer detects the three channels of P-SCH, S-SCH, and PCPICH to establish the synchronization and correct the frequency and phase for the down-link signal analysis. If these channel levels are too low to be detected, the analyzer cannot make measurement correctly. This error occurs when one of these channel levels is less than about 1/10th the sum of other channel levels. In this case, set **Scrambling Code Search** to **Off** and specify the scrambling code with **Scrambling Code** in the 3gppPolar view menu using the following steps.*

- a. Press the VIEW:C key to select the 3gppPolar view.
- b. Press the side key **Options...** → **Scrambling Code Search** and select **Off**, allowing you to enter a scrambling code.
- c. Press the **Scrambling Code** side key and set the value.

The analyzer will use the scrambling code that you have set instead of searching for the scrambling code to analyze the down-link signal.

- d. Press the START/STOP:**BLOCK** key to start data acquisition.
After the data acquisition, the first slot is analyzed.
- e. Press the VIEW:C key to select the 3gppPolar view.
- f. Press the [**View C**] <- side key (top side key) to show the top menu.
- g. Press the **Analyze** side key to analyze for all frames.

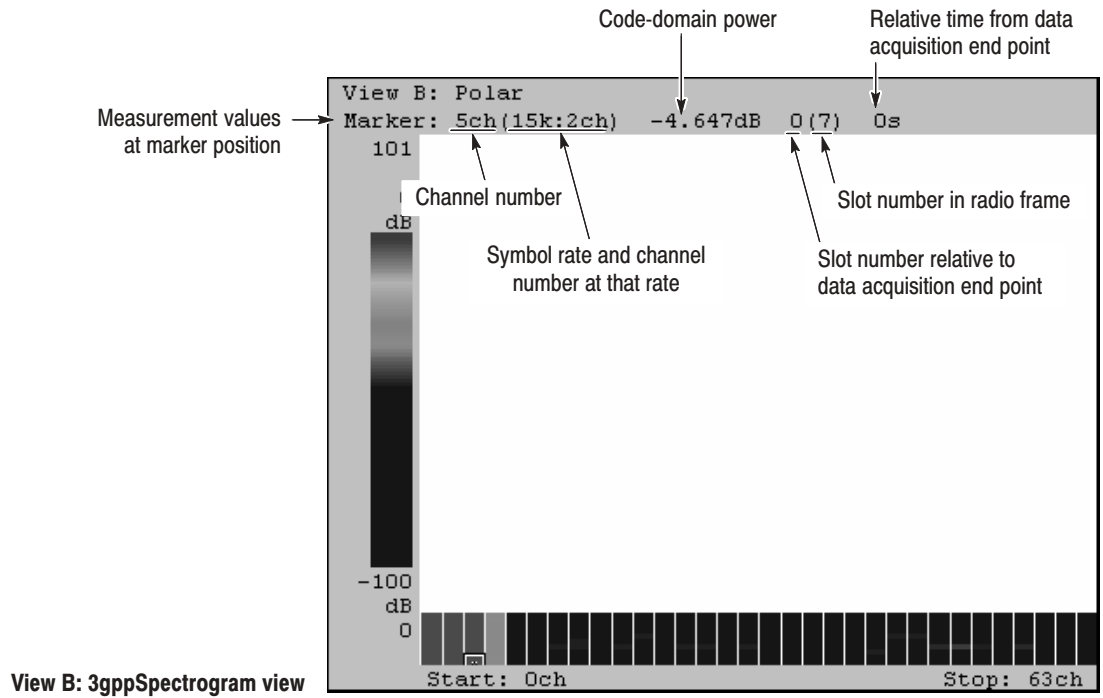

Figure 3-76: Code-domain power spectrogram

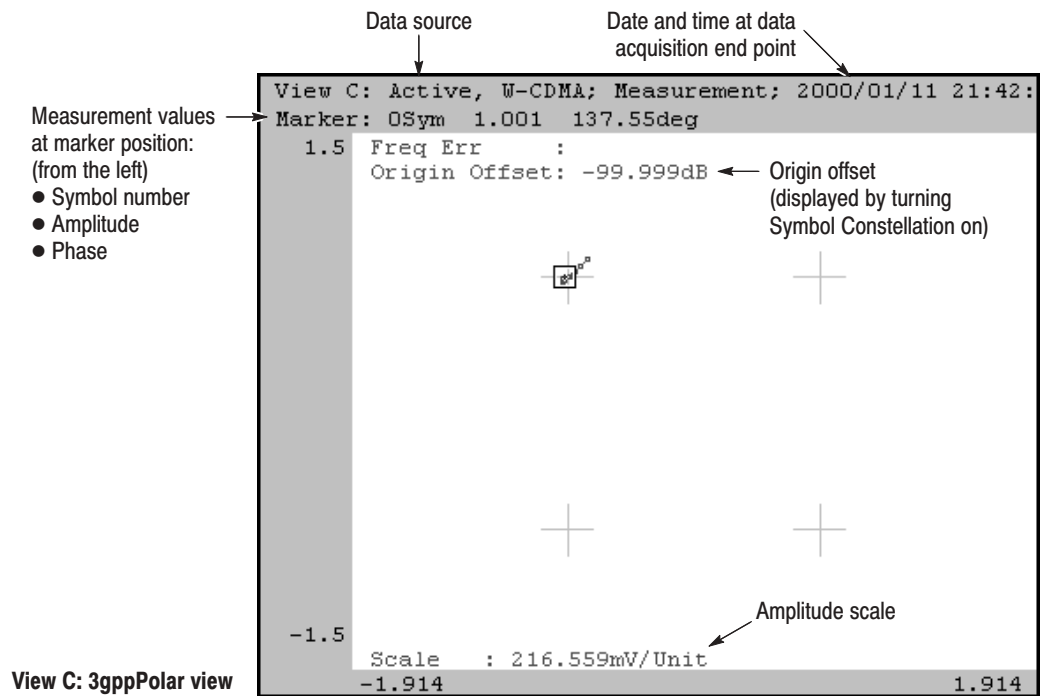

Figure 3-77: Symbol constellation

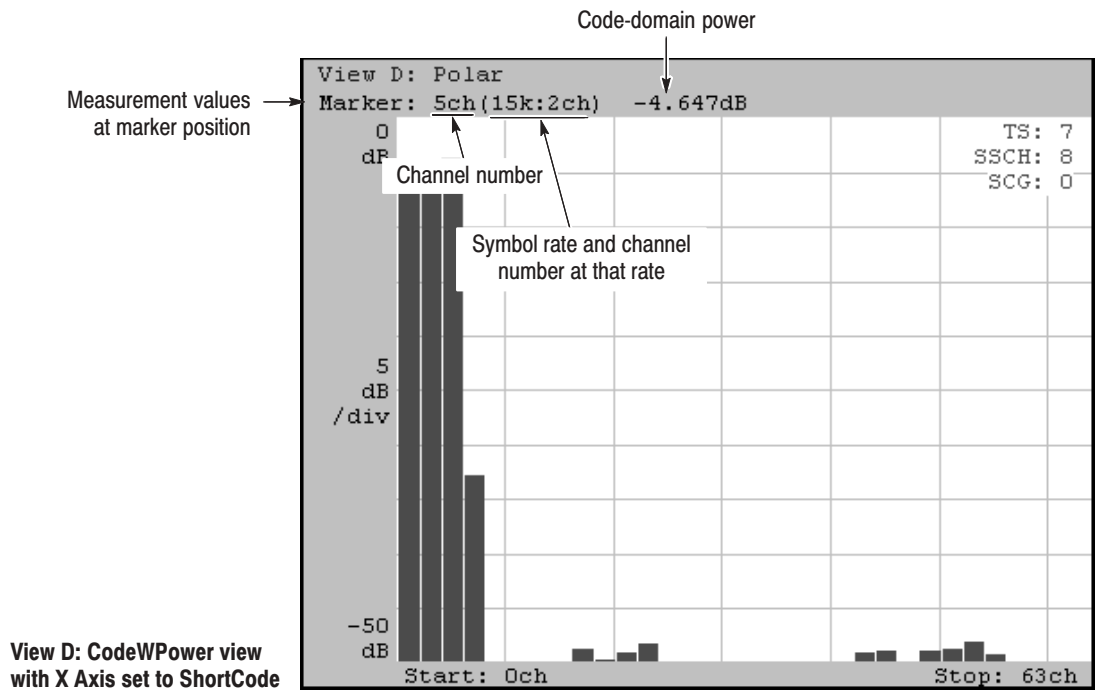

Figure 3-78: Code-domain power

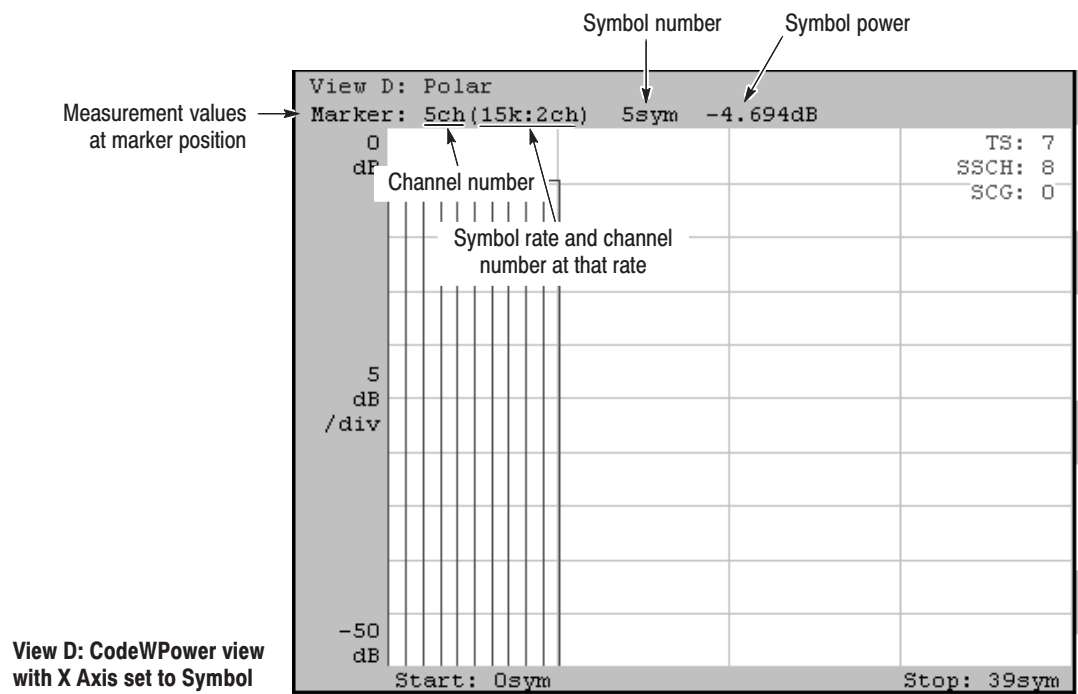

Figure 3-79: Symbol power

3GPP ACP Measurement

Use the 3gppACPView menu to measure ACP (Adjacent Channel Leakage Power) according to the 3GPP standard.

Restrictions

There are some restrictions on the 3GPP ACP measurement.

- The data stored in the data file (*.IQ, *.AP) is not available.
- The displayed data can be stored in the text format.
- Data is always acquired in the D5 register. Usually, use the default D5 register as the view data source (the source is specified with Source in the 3gppACPView menu).

Basic Procedure

The following is the basic procedure for measuring ACP under 3GPP.

1. Press CONFIG:MODE → More... → 3GPP...
2. Press the **ACP** side key to configure the analyzer for the 3GPP ACP measurement.

View A is defined as 3gppACPView.

For details on the 3gppACPView menu, refer to page 2–100.

3. Press VIEW:A to display 3gppACPView.
4. Press the **ROLL** key to start data acquisition.
5. When you turn on the receive filter, press the **Filter** side key to select **On**.
6. If necessary, set the band power marker and receive filter parameters by pressing VIEW:A → VIEW:MKR → ACP...

For the band power marker operations, refer to page 3–90.

7. Displayed data can be stored in the text format with the following steps:
 - Press VIEW:MAIN → Options... → Copy To... → Text File, and specify the file.

When you retrieve the data from the file, do the following steps:

- Press VIEW:MAIN → Options... → Copy From... → Text File, and specify the file.

Figure 3–80 is an example of the 3GPP ACP measurement.

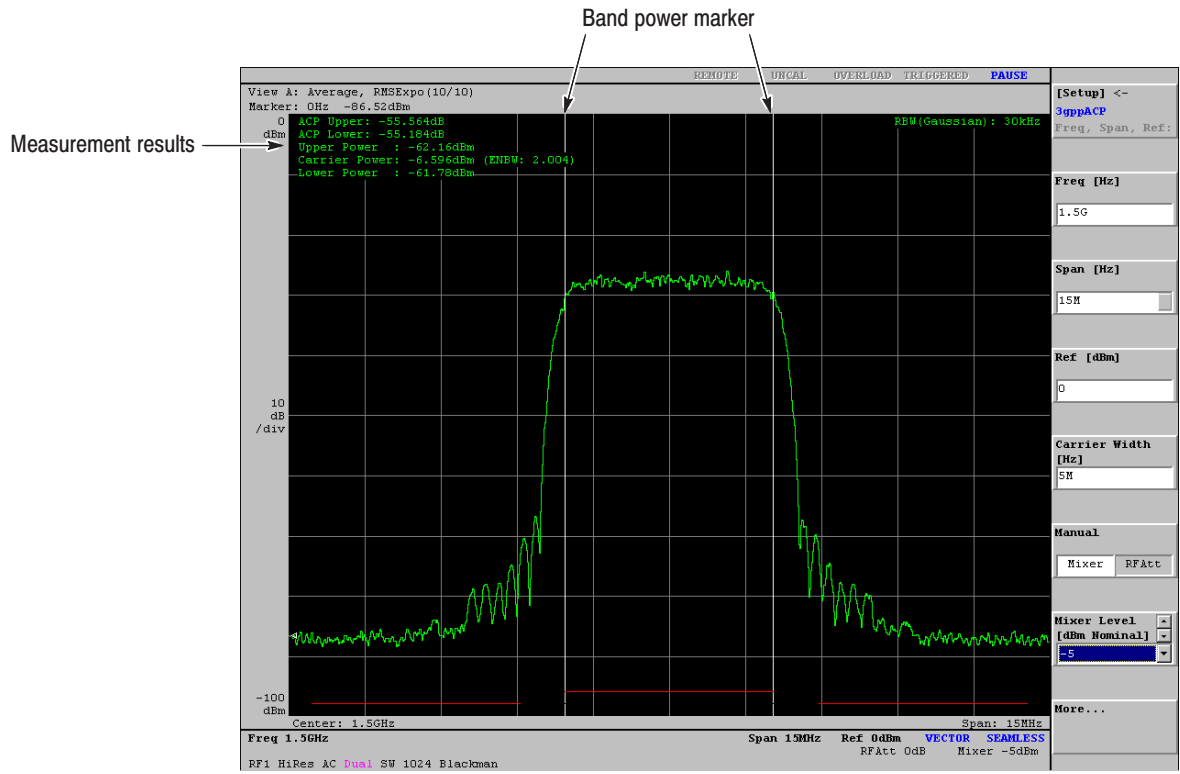

Figure 3-80: 3GPP ACP measurement example

GSM Analysis

This chapter describes the measurement procedures according to the GSM (Global System for Mobile Communication) standard. The following topics are discussed:

- Measurement functions
- Basic operations
 - Selecting the GSM measurement
 - Modulation accuracy measurement
 - Output power measurement
 - Power vs. Time measurement
 - Spectrum (MOD) measurement
 - Spectrum (SW) measurement
 - Analyzing file data
- Entering the sync word

Measurement Functions

The analyzer has five GSM measurement functions.

Table 3-18: GSM measurement functions

Measurement type	Standard	Measurement item
Modulation accuracy	GSM 11.20-2.1.6.2	Phase error and frequency error
Output power	GSM 11.20-2.1.6.3	Mean carrier power
Power vs. Time	GSM 11.20-2.1.6.4	Power vs. Time
Spectrum (MOD)	GSM 11.20-2.1.6.5.1	ACP for a continuous modulation spectrum
Spectrum (SW)	GSM 11.20-2.1.6.5.2	ACP for a switching transient spectrum

- *Modulation accuracy*

The analyzer measures the modulation phase error and mean frequency error according to the GSM 11.20-2.1.6.2 standard.

The measurement and test is performed for the center 147 bits of each burst. The test passes if the following conditions are satisfied:

- Peak phase error < 20°
- RMS phase error < 5°
- Frequency error < 0.05 ppm of the center frequency

- *Output power*

The analyzer measures the mean carrier power according to the GSM 11.20-2.1.6.3 standard.

Figure 3-81 shows the slot data structure. The power is measured for the E (Data 2) section after TS (Training Sequence) and then averaged for the specified number of slots. The decision is “Pass” if the following condition is satisfied:

$$0 \text{ dB} < (\text{Output power}) - (\text{Reference power}) < 3 \text{ dB}$$

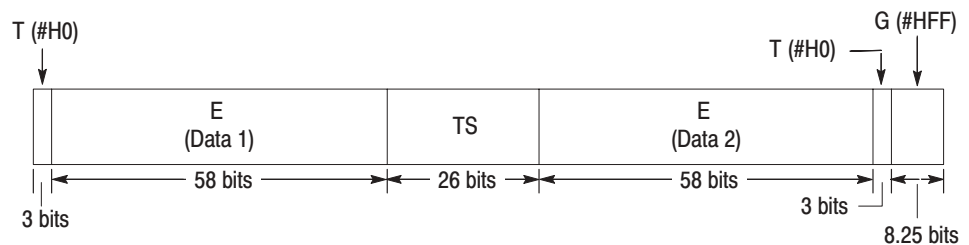

Figure 3-81: Slot data structure

- *Power vs. Time*

The analyzer measures the power vs. time according to the GSM 11.20-2.1.6.4 standard.

The input signal is demodulated and then synchronized with TS (Training Sequence). The Pass/Fail test is done for the spectrum in comparison with the specified line in the GSM standard.

- *Spectrum (MOD)*

The analyzer measures ACP (Adjacent Channel Leakage Power) for a continuous modulation spectrum according to the GSM 11.20-2.1.6.5.1 standard.

The spectra are obtained for 160 μ s after TS (Training Sequence) using software FFT with the 4-sample Blackman-Harris window and the 30 kHz RBW Gaussian filter, and then averaged for the specified number of slots. The Pass/Fail test is done for the averaged spectrum in comparison with the specified line in the GSM standard.

- *Spectrum (SW)*

The analyzer measures ACP (Adjacent Channel Leakage Power) for a switching transient spectrum according to the GSM 11.20-2.1.6.5.2 standard.

The spectra of bursts are calculated with the 30 kHz RBW Gaussian filter, and then peak-held for the specified number of slots. The Pass/Fail test is done for the peak-held spectrum in comparison with the specified line in the GSM standard.

Basic Operations

Selecting the GSM Measurement

This section shows the fundamental procedures for GSM analysis.

1. Press the CONFIG:MODE key.
2. Press the **More...** side key twice.
3. Press the **GSM Measurement** side key to configure the analyzer for the GSM measurement.

Default views are as follows:

View A: GSMPolar view
View B: SymbolTable view
View C: EVM view
View D: GSM view

For details on the view menus, refer to *Menu Functions* on page 2–47.

4. Press the VIEW:D key to display the GSM view menu.

There are five selection items in the **Measurement** menu as described in the previous section, *Measurement Functions*. Refer to each section for the procedures as listed below:

Mod.Accuracy	page 3–155
OutputPower	page 3–156
PowerVSTime	page 3–157
Spectrum (MOD)	page 3–158
Spectrum (SW)	page 3–160

If you want to analyze data on a file, refer to *Analyzing File Data* on page 3–162.

NOTE. *If the input signal is nonstandard, measurement results are not displayed on the screen (waveforms may be displayed if triggered).*

Modulation Accuracy Measurement

1. Select **Mod.Accuracy** (default) with the **Measurement** side key in the GSM view menu. (Refer to *Selecting the GSM Measurement* on page 3–154).

2. Press the **Measure** side key to start acquiring data.

The analyzer repeats to measure for each burst and display the result and waveform on View A to D.

3. Press the **ROLL** or **BLOCK** key to stop the acquisition.

4. Press the **Analyze** side key to analyze the data acquired on the memory.

The analyzer repeats to measure for each burst and display the result and waveform on View A to D, showing the burst number on View D.

If you want to quit, press the **ROLL** or **BLOCK** key.

5. Press the **Burst No.** side key and select a burst number.

View A to D show the measurement result for the specified burst.

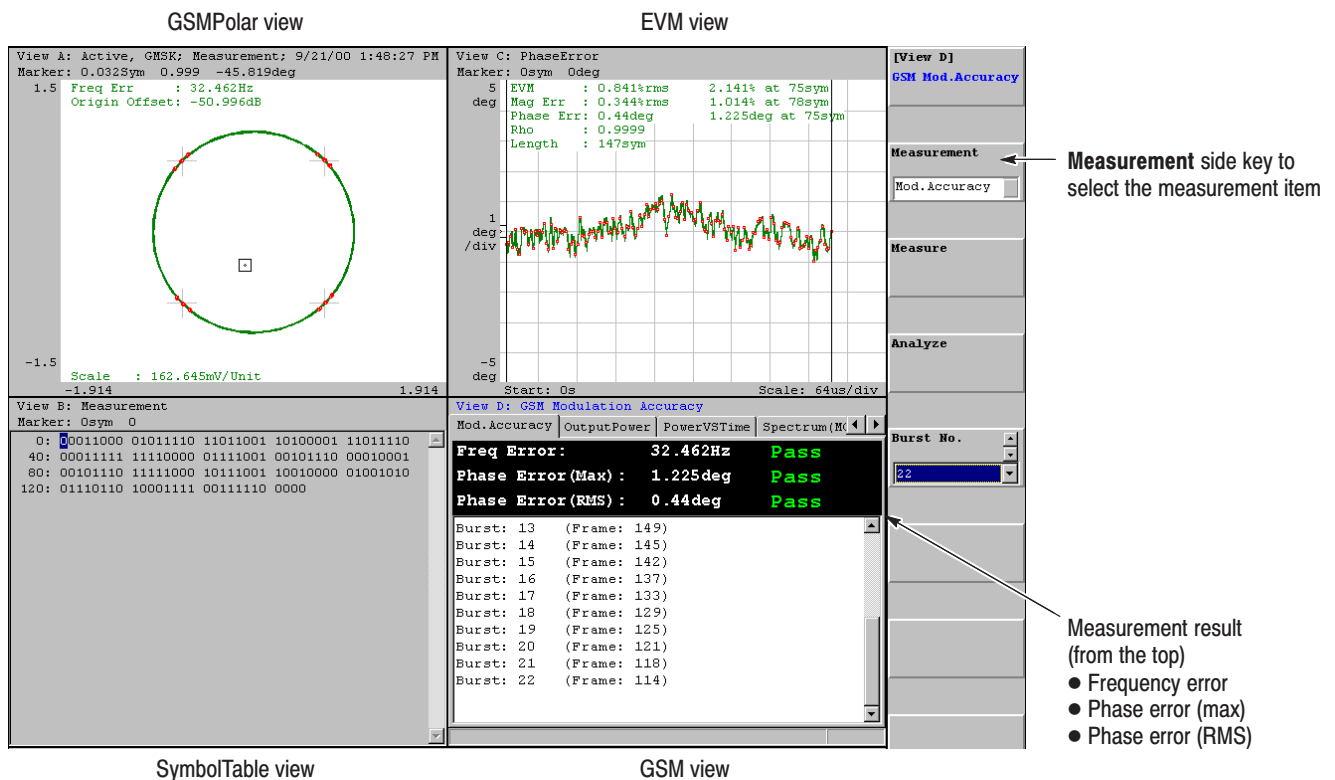

Figure 3–82: Modulation accuracy measurement

Output power Measurement

1. Select **OutputPower** with the **Measurement** side key in the GSM view menu. (Refer to *Selecting the GSM Measurement* on page 3–154).
2. Press the **Burst Count** side key and set the number of bursts to acquire.
3. Press the **Measure** side key to start acquiring data.

The analyzer repeats to measure for each burst and display the result and waveform on View A to D.

If you want to quit, press the **ROLL** or **BLOCK** key.

4. Press the **Analyze** side key to analyze the data acquired on the memory.

The analyzer repeats to measure for each burst and display the result and waveform on View A to D, showing the burst number on View D.

If you want to quit, press the **ROLL** or **BLOCK** key.

5. Press the **Burst No.** side key and select a burst number.

View A to D show the measurement result for the specified burst.

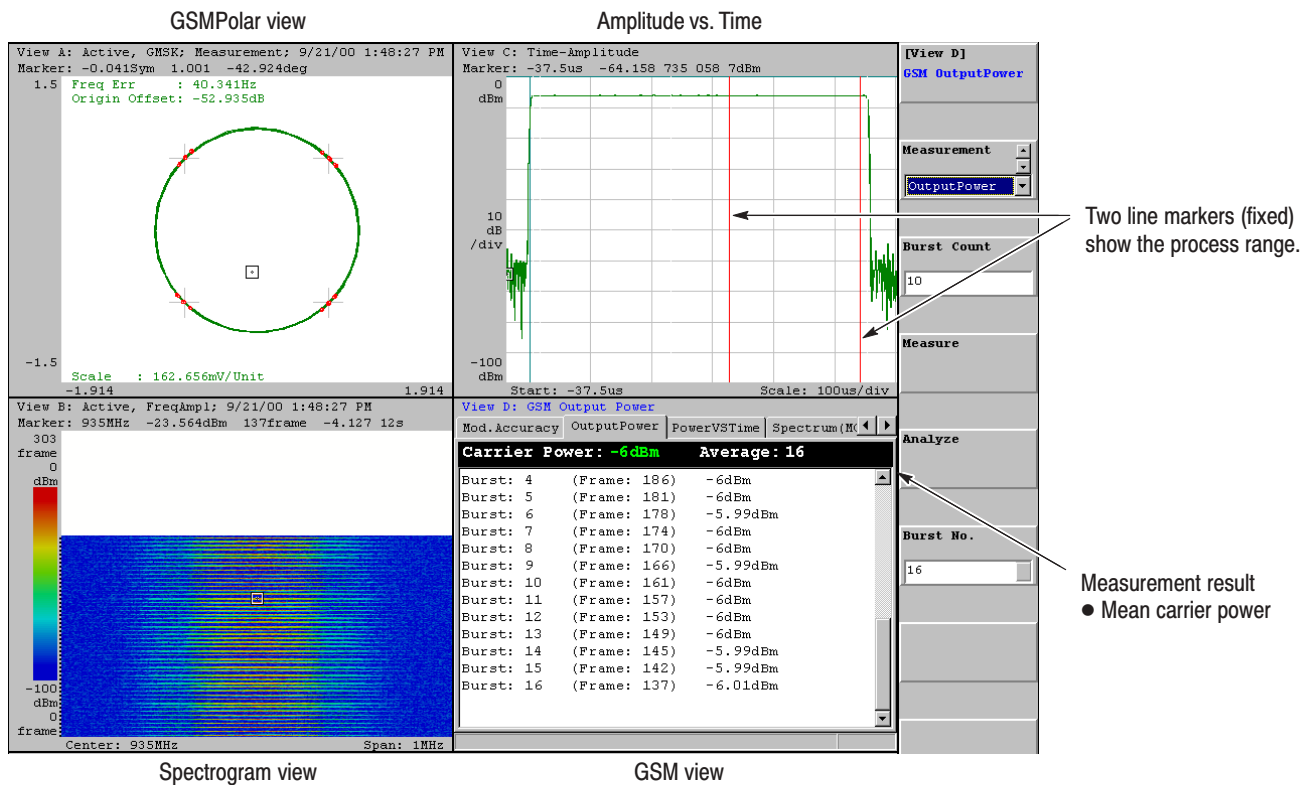

Figure 3–83: Output power measurement

Power vs. Time Measurement

1. Select **PowerVSTime** with the **Measurement** side key in the GSM view menu. (Refer to *Selecting the GSM Measurement* on page 3–154).
2. Press the **Measure** side key to start acquiring data.

The analyzer repeats to measure for each burst and display the result and waveform on View A to D. View C, called GSMMask view, shows the Pass/Fail test with the specified mask in the GSM standard. For details on the GSMMask view menu, refer to page 2–111.

3. Press the **ROLL** or **BLOCK** key to stop the acquisition.
4. Press the **Analyze** side key to analyze the data acquired on the memory.

The analyzer repeats to measure for each burst and display the result and waveform on View A to D, showing the burst number on View D.

If you want to quit, press the **ROLL** or **BLOCK** key.

5. Press the **Burst No.** side key and select a burst number.

View A to D show the measurement result for the specified burst.

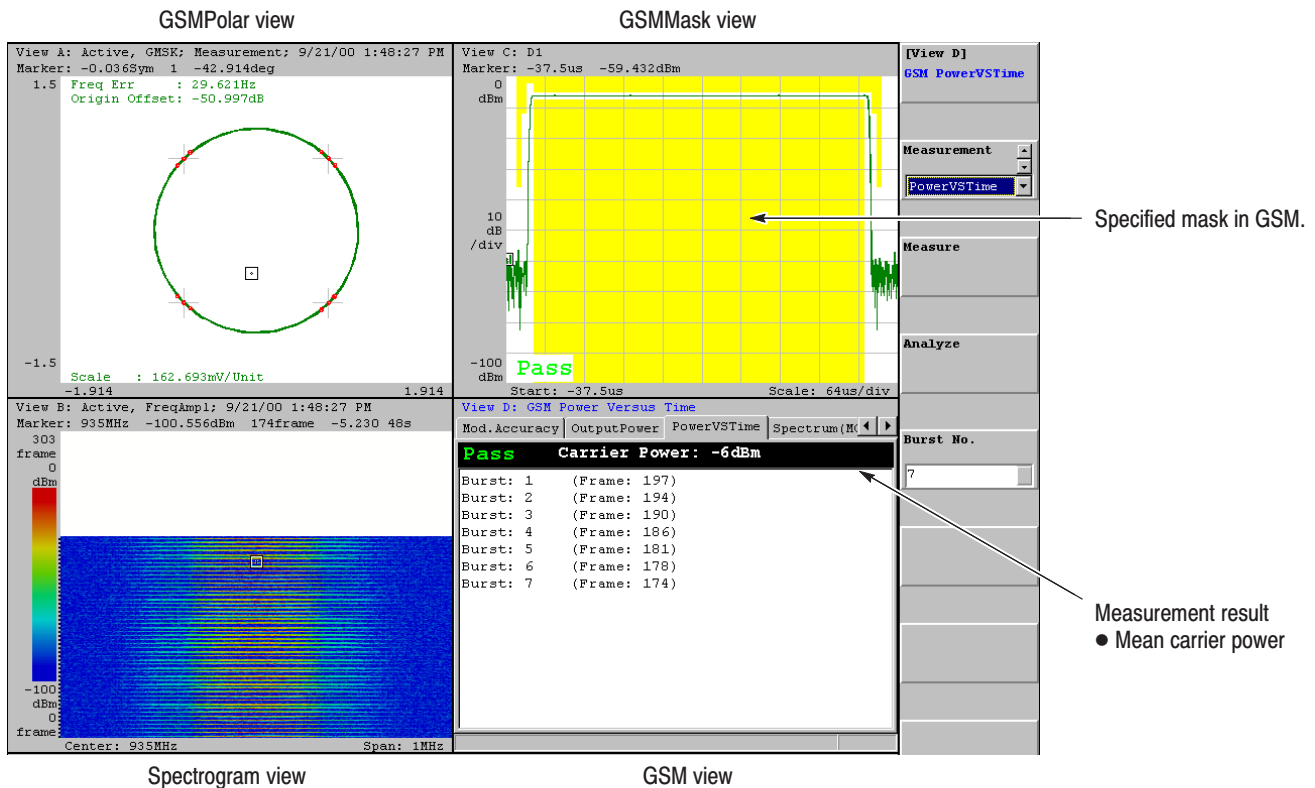

Figure 3–84: Power vs. Time measurement

**Spectrum (MOD)
Measurement**

1. Select **Spectrum (MOD)** with the **Measurement** side key in the GSM view menu. (Refer to *Selecting the GSM Measurement* on page 3–154).
2. Press the **Burst Count** side key and set the number of bursts to acquire.
3. Press the **Measure** side key to start acquiring data.

The analyzer acquires bursts by the number specified with **Burst Count**, averaging the spectrum. View A and C display the vector diagram and the amplitude versus time waveform for each burst, respectively. View B displays the averaged spectrum with the specified line in the GSM standard. Pass/Fail is shown in View D. See Figure 3–85.

If you want to quit, press the **ROLL** or **BLOCK** key.

NOTE. *If no GSM burst is found, the specified line is not displayed.*

4. Press the **Analyze** side key to analyze the data acquired on the memory.

The analyzer displays the measurement result and waveform as in step 3.

If you want to quit, press the **ROLL** or **BLOCK** key.

5. Press the **Burst No.** side key and select a burst number.

View A to D show the measurement result for the specified burst.

In this case, View B displays raw data of the specified burst (not averaged).

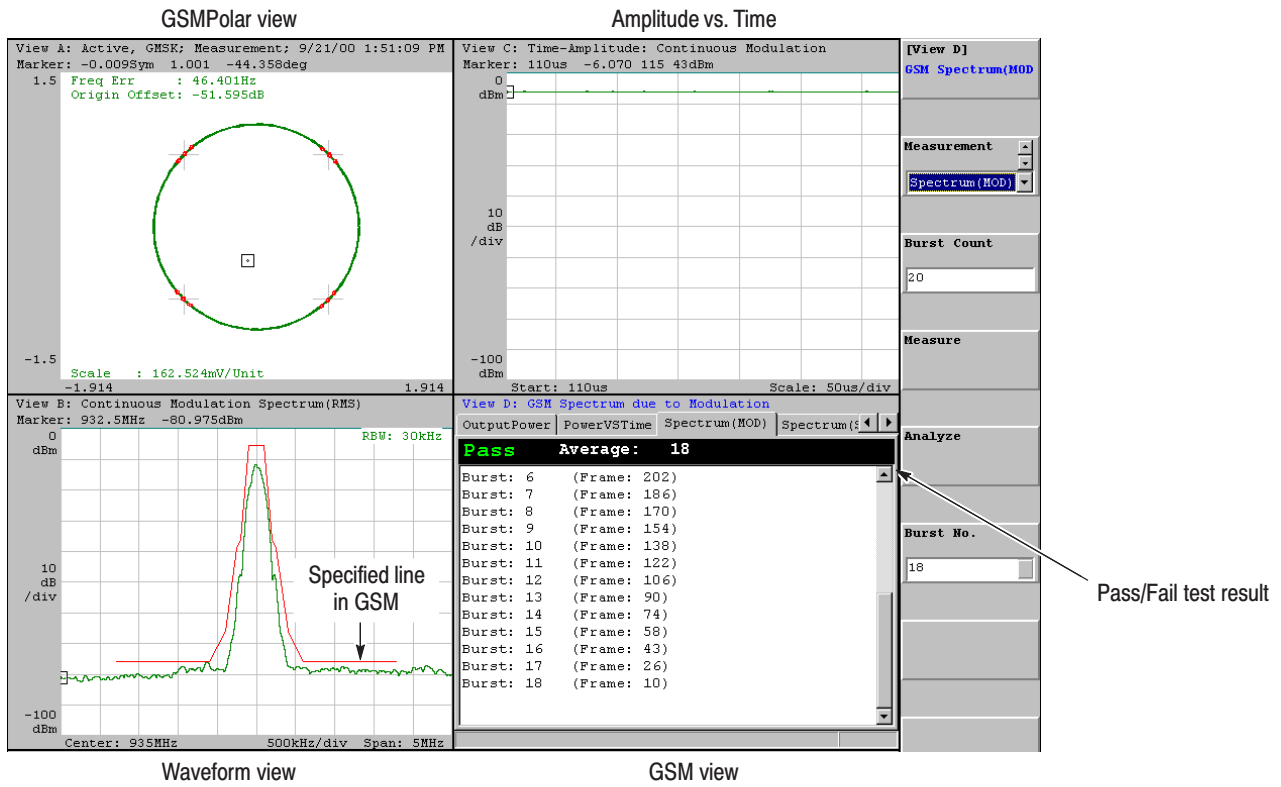

Figure 3-85: Spectrum (MOD) measurement

**Spectrum (SW)
Measurement**

1. Select **Spectrum (SW)** with the **Measurement** side key in the GSM view menu. (Refer to *Selecting the GSM Measurement* on page 3–154).
2. Press the **Burst Count** side key and set the number of bursts to acquire.
3. Press the **Measure** side key to start acquiring data.

The analyzer acquires bursts by the number specified with **Burst Count**, peak-holding the spectrum. View A displays the spectrogram for the acquired data. View B shows the peak-held spectrum with the specified line in the GSM standard. View C displays the vector diagram for the burst that was acquired first to obtain the carrier frequency and burst-on level. Pass/Fail is shown in View D. See Figure 3–86.

If you want to quit, press the **ROLL** or **BLOCK** key.

NOTE. *If no GSM burst is found, the specified line is not displayed.*

4. Press the **Analyze** side key to analyze the data acquired on the memory.

The analyzer displays the measurement result and waveform as in step 3.

If you want to quit, press the **ROLL** or **BLOCK** key.

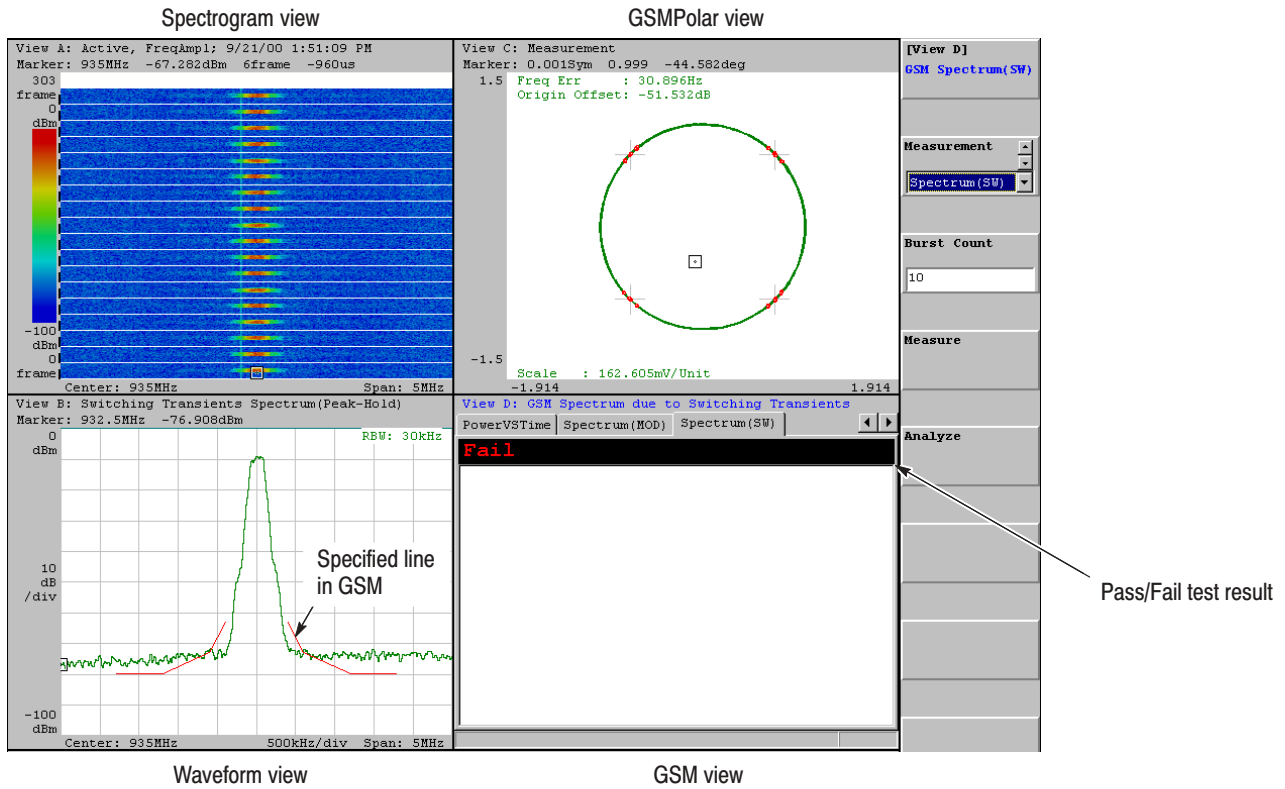

Figure 3-86: Spectrum (SW) measurement

Analyzing File Data

If you want to analyze data on a file (*.IQ), follow this procedure:

NOTE. *The IQ-formatted file is available for the GSM measurement.*

1. Select one of the five items with the **Measurement** side key in the GSM view menu. (Refer to *Selecting the GSM Measurement* on page 3–154).
2. Load a file:
 - a. Press CONFIG:UTILITY → Util B [SaveLoad] → Load... → **Load From File (*.IQ)**.
 - b. Select a file. Refer to *Operating File Access Menu* on page 3–178 for selecting a file.
3. Press the VIEW:D key to show the GSM view menu.
4. Press the **Analyze** side key to analyze the data loaded on the memory.

The analyzer repeats to measure each burst and display the result and waveform on View A to D.

If you want to quit, press the **ROLL** or **BLOCK** key.

5. Press the **Burst No.** side key and select a burst number.
(This side key is not available in the Spectrum (SW) measurement.)

View A to D show the measurement result for the specified burst.

NOTE. *When you change the measurement item with the **Measurement** side key in the GSM view menu, the analyzer clears the data loaded from a file onto the memory.*

Entering the Sync Word

For the GSM measurement, the analyzer always searches the sync word. The default sync word is TSC0 (Training Sequence Code: #H25C225C) specified in the GSM standard. You can select the sync word from TSC0 to TSC7, or enter an arbitrary sync word in the GSMPolar view with the following procedure. For information on the GSMPolar view menu, refer to page 2–108.

1. Select the measurement item with the **Measurement** side key in the GSM view menu. (Refer to *Selecting the GSM Measurement* on page 3–154).
2. Select the GSMPolar view. For example, if View A is defined as the GSMPolar view, press the VIEW:A key.
3. Press the **Sync Word...** side key.
For details on the Sync Word submenu, refer to page 2–109.
4. Press the **Sync Word Pattern** and select **User**.
5. Press the **Sync Word Entry...** side key and then edit the sync word in the **Sync Word** field in hexadecimal numbers (see Figure 3–87).
 - Press the **Position** side key to move the cursor to input a number.
 - Press **Delete** side key to delete the number at the cursor position.
 - Press one of the side keys from **0 1 2 3...** to **C D E F...** and then select a number.

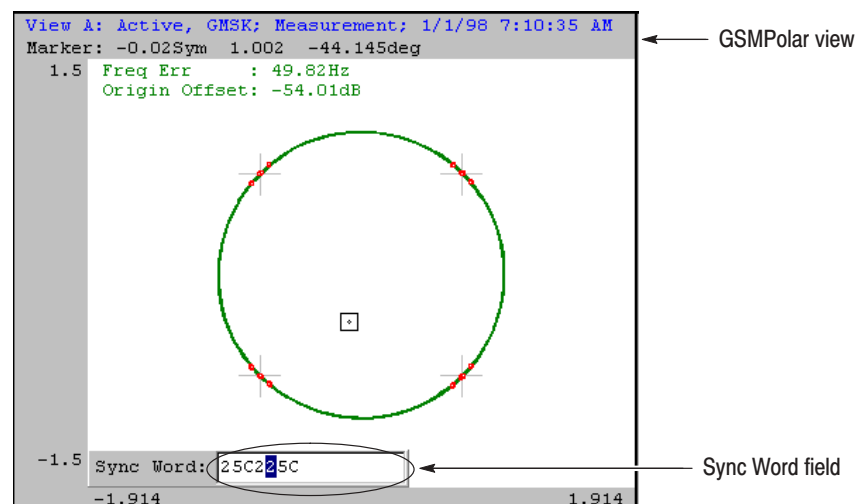

Figure 3–87: Entering a sync word in the GSMPolar view

6. When you finish entering the word, press **OK** to exit the sync word entry.
7. Set the sync word length in bits with the **Sync Word Length** side key, if necessary (the default setting is 26 bits).
 - If you set the length greater than the sync word that you have entered, the remaining lower bits are set to 0.
 - If you set the length less than the sync word that you have entered, the remaining lower bits are ignored.
8. Press the **VIEW:D** key and perform measurement.

The analyzer acquires data, searching for the sync word. If the sync word is found, waveforms and measurement results are displayed on screen.

Although **Sync Word Search** and **Differential Encoding** are set to *Off* by default in the **Sync Word...** menu, the analyzer always turns them *On* for the GSM measurement.

NOTE. *The sync word is reset to TSC0 (default) when you change the measurement item with the **Measurement** side key in the GSM view menu.*

CCDF Analysis

This chapter describes the CCDF (Complementary Cumulative Distribution Function) analysis functions. The following topics are discussed.

- About CCDF analysis
- Operating examples

About CCDF Analysis

CCDF (Complementary Cumulative Distribution Function) represents the probability that the peak power above average power of input signals exceeds a threshold. The analyzer displays the ratio of peak power to average power along the horizontal axis and the probability that the ratio is exceeded along the vertical axis.

The CCDF in conjunction with the real-time analysis function allow you to measure the time-varying crest factor quantitatively in time series for code-multiplexing signals such as CDMA/W-CDMA signals, and multi-carrier signals such as OFDM signals.

Calculation Process CCDF is calculated with the following formula.

$$SP(X) = \int_X^{Max} P(Y) dY$$

$$CCDF(X) = SP(X + Average)$$

$$CCDF(crest\ factor) = 0$$

where
 P: Probability density
 Max: Maximum of amplitude
 Average: Average of amplitude

The analyzer processes input signals internally with the following procedure (see Figure 3–88).

1. Measure the amplitude of the input signal over time.
2. Determine the amplitude distribution.
3. Obtain CCDF using the above formula.

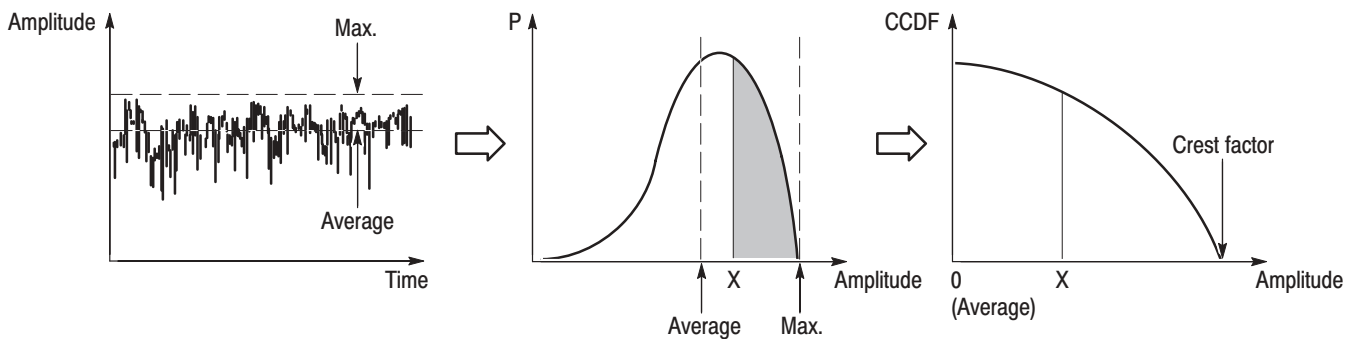



Figure 3–88: CCDF calculation process

Operating Examples

The following procedure measures CCDF in View G and H. View A to F might be used for another measurement such as cdmaOne and W-CDMA.

1. Press the  key in the front panel VIEW area to make the 4-view display.
2. Press the CONFIG:MODE key.
3. Press the More... side key.
4. Press the CCDF side key with the icon.

View G is set to the CCDF view and View H to the CCDFView display automatically.

5. Press the VIEW:C key one or two times (depending on the settings) to display the View G menu. (View G is the back screen of View C).
6. Press the Calculate... side key.
7. Set the CCDF calculation range using the **Begin Frame** and **End Frame** side keys. The unit frame period is as follows:
 - W-CDMA: 50 μ s for 10 MHz span
25 μ s for 20 or 30 MHz span.
 - cdmaOne: 160 μ s for 5 MHz span
8. Press **Execute** side key to start the process. The results are shown in View G and H (see Figure 3–89 and 3–90).
9. Press the VIEW:D key one or two times (depending on the settings) to display the View H menu. (View H is the back screen of View D).
10. Press VIEW:SCALE key. The side keys are displayed to set the horizontal and vertical scales. The maximum value on the horizontal axis displayed by default is the crest factor.
11. When you replace View G or H with View C or D, press the VIEW:C or D key one or two times (depending on the settings).

For details on the CCDF and CCDFView menus, refer to page 2–112 and 2–114, respectively.

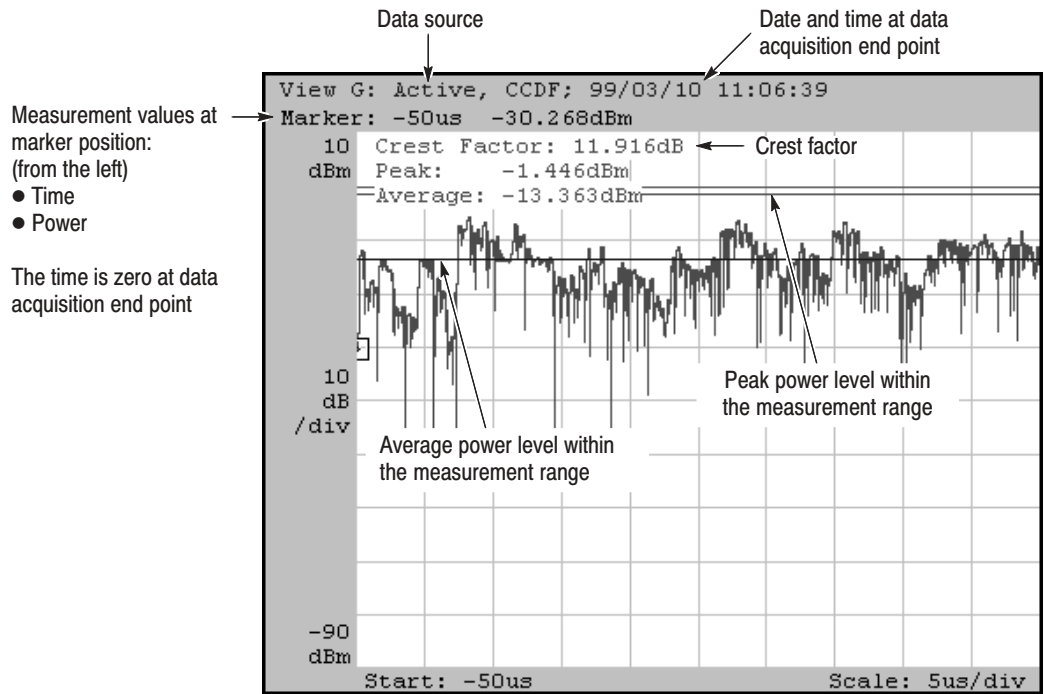

Figure 3-89: CCDF measurement (View G)

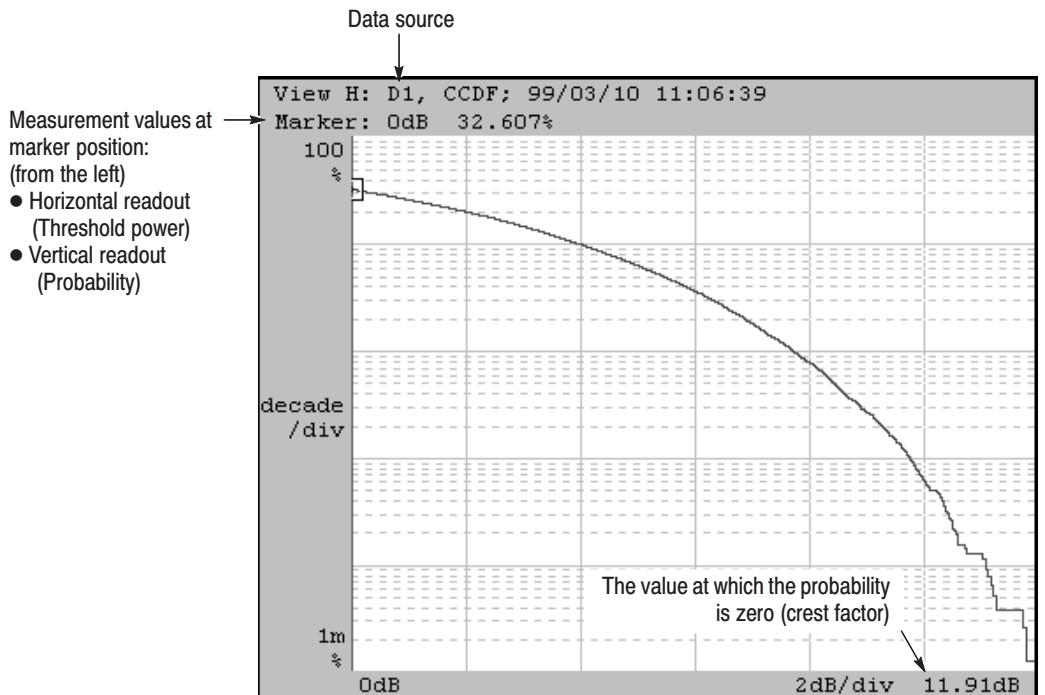

Figure 3-90: CCDFView display (View H)

Auto-Save Function

The auto-save function stores captured data into specified files while acquiring data. It operates in the AutoSave view with two modes: the RollSave mode for the Roll acquisition and the BlockSave mode for the Block acquisition. With the auto-save function, you can save data to files in a long time acquisition for further analysis.

Restrictions

- The auto-save function operates with the analyzer basic application software version 3.12 or later.
- In the Block mode, the analyzer does not start the next acquisition until all of the one-block data acquired has been stored into a file.
- The time required for the file write depends on the block size (i.e., the number of frames) and the destination media (HD, FD, MO, JAZZ, or network disk, etc.). For the same media type, the access time additionally varies with the internal state of the media.

For example, suppose you store the data onto the analyzer hard disk drive (HDD). If the settings are 4,000 frames per block and 1,024 points per frame, the file capacity per block is a maximum of 16 MB. It takes about 15 seconds to write the file. If the block size is about a one- or two-digit number of frames, it still takes about a two- or three-digit number of milliseconds.

- For logging a one-shot event, the function can be used effectively if you have specified a proper number of frames. If you want logging occurring at regular intervals or time reduction between blocks (guaranteeing the minimum time), this function may not work for you. Refer to *Frame Period and Real Time* on page 3–25 for details.

Operating Procedure

The following procedure is a typical example of the auto-save operation.

1. Boot up the analyzer.
2. Set up the analyzer and press the **BLOCK** or **ROLL** key.
Check that signals are actually observed.
3. Press the **CONFIG:VIEW** key.

2- or 4-view display is more convenient to observe spectrum. See Figure 3-91. In this example, use 4-view display to observe spectrum waveform in two views and operate two auto-save modes in the other two views:

View A: Waveform view
View B: Spectrogram view
View C: AutoSave (RollSave mode)
View D: AutoSave (BlockSave mode)

Press the **View A** to **D** side keys to select each view as above.
Select **AutoSave** in View C and D in this step.

4. Select either of the following auto-save modes in View C and D:
 - **RollSave**: Save the data captured in the Roll mode.
 - **BlockSave**: Save the data captured in the Block mode.

One of the two modes is actually used depending on the acquisition mode.

- a. Press **View:C** → **Mode** and then select **RollSave**.
 - b. Press **View:D** → **Mode** and then select **BlockSave**.
5. Specify the name of the destination file.

If you skip this specification, by default the files are stored in the following folder which contains the WCA system programs:

C:\Program Files\SONY Tektronix\WCA\Bin

The example in Figure 3-91 has specified that the data is stored in the following files:

RollSave view C:\Users\PROJ-E\R01*.IQ
BlockSave view C:\Users\PROJ-E\B01*.IQ

- a. Press **View:C** → **File Name** and then specify a file name.
- b. Press **View:D** → **File Name** and then specify a file name.

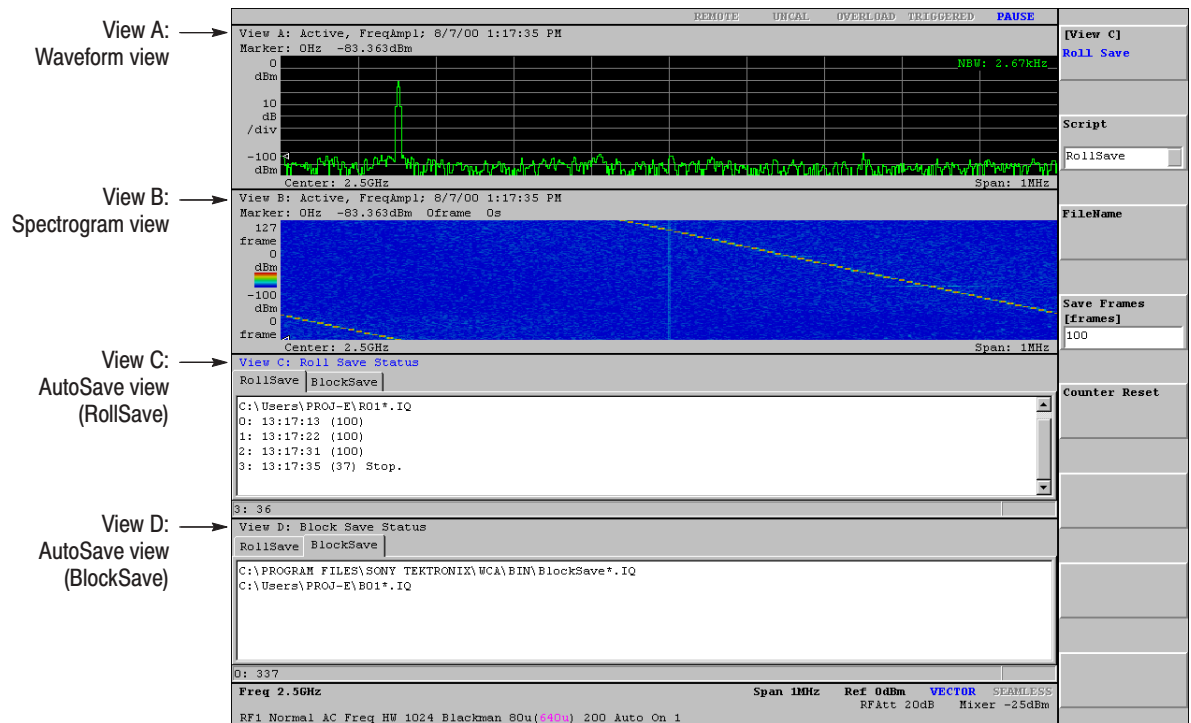

Figure 3–91: Auto-save views in two modes (View C and D)

For any destination file actually containing stored data, a serial number, beginning with 0, is added before the file extension .IQ (in this example, B010.IQ, B011.IQ, B012.IQ, ...). If time domain data is captured in the analyzer memory, .IQT files are also created automatically. If a file with the same name already exists, it is overwritten with the new one.

6. For the RollSave view, set the number of frames to be stored with the **Save Frames** side key, if necessary (the default is 100 frames).

7. Press the **ROLL** or **BLOCK** key to start acquisition.

The auto-save mode depends on the key you pressed. In the Roll mode, the RollSave view functions. In the Block mode, the BlockSave view functions. The analyzer continues to store data into files until the data acquisition completes.

8. If you want to restart to store data from the file with a serial number 0, press the **Counter Reset** side key. The files that have been previously made will be overwritten.
9. When you stop the acquisition, press the **ROLL** key (in the Roll mode) or **BLOCK** key (in the Block mode) again.

In the Roll mode, the data is output to the specified file each time the specified number of frames have been captured. Suppose that you have specified 600 frames in the **Save Frames** menu item in the view. One file is created each time 600 frames have been captured in this case. See Figure 3-92.

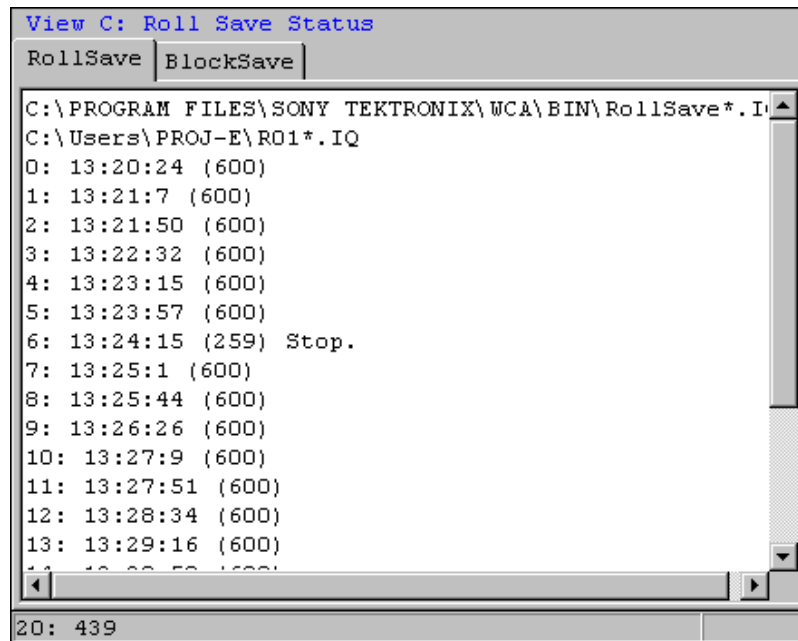

Figure 3-92: Automatic data storage in the Roll mode

In the Block mode, the data is output to the specified file each time one block is captured. Suppose that you select **SETUP** → **Trigger** → **Count** and turn on the trigger count and select **SETUP** → **Trigger** → **Times** to set the count value to 4. The following four or eight files are created in this case:

B010.IQ (, B010.IQT)
B011.IQ (, B011.IQT)
B012.IQ (, B012.IQT)
B013.IQ (, B013.IQT)

Loading the Data

Refer to *Load* on page 3-176. If the IQT-formatted file exists, it is also read automatically with specifying the IQ-formatted file only.

File Operations

The settings and data in the analyzer can be saved in files. This section describes how to handle the files. The following topics are included:

- Saving and loading files page 3-174
- Operating file access menu . . . page 3-178
- Data file format page 3-184

Saving and Loading Files

You can save or load the settings or data on the hard disk or a floppy disk using the Save and Load menus.

Available Files

The analyzer can save and load any file with one of the extensions listed in Table 3–19.

Table 3–19: Files available in the analyzer

Extension	Description
.CFG	A configuration file used to save the current settings.
.IQ	A file used to save IQ-formatted data. I stands for in-phase. Q stands for quadrature phase, which is orthogonal to I. When data is written into the data memory, the IQ format is always used. This data can be saved into the file as it is.
.AP	A file used to save AP-formatted data. A and P stand for amplitude and phase, respectively. The contents of the data memory are converted into the AP format from the IQ format before being saved.

Configuration File (.CFG)

The configuration file contains the settings in all menus. You can save the current configuration and settings in this kind of file. You can also load the contents of this file to restore the saved instrument settings.

Save. Save the settings in a file.

1. Press the CONFIG:MODE key.
2. Press the **Save To File (*.CFG)** side key.

The file access menu appears. Select the destination drive and directory for save. Set the file name (not including the extension) and save the file. Refer to *Operating File Access Menu* on page 3–178 for detail.

Load. Load the file and set up the .

1. Press the CONFIG:MODE key.
2. Press the **Load From File (*.CFG)** side key.

The file access menu appears. Select the drive and directory in which the file is located, and load it. Refer to *File Menu Operations* on page 3–178 for detail.

Data File (*.IQ, *.AP)

The data file transfers the IQ- or AP-formatted data between the data memory and a file.

Save. You can save the data residing in the data memory using the Save function in the UTILITY. When the data is saved, part of the setting information is saved to allow the data to be displayed normally when being loaded.

1. Display the SaveLoad menu:
 - a. Press the CONFIG:UTILITY key.
 - b. Press the **Util B [Save Load]** side key.
 - c. Press the **Save...** side key.
2. Press the **Source** side key to select the data source.

If you select **Active**, the data in the data memory will be saved. If the data has been zoomed, you can save it by selecting **Zoom**.
3. Select the frame range you want to save with one of the following ways:
 - Define the first and last frames in **Begin Frame** and **End Frame**.
 - Press the **All Frames** side key to save all frames acquired.
 - Press the **Mkr -> Frame** side key to save the frames from #0 to the one in the marker position.
4. Press the **Save To File (*.IQ)** or **Save To File (*.AP)** side key to save the IQ- or AP-formatted data, respectively.

The file access menu appears. Specify the device, directory, and file name before saving. Refer to *Operating File Access Menu* on page 3-178 for detail.

The analyzer uses the IQ format to write data into the memory. The IQ-formatted data is represented with the horizontal and vertical axes, but not represented with the I and Q axes of the IQ diagram. The AP-formatted data is calculated from the IQ-formatted data and represented in the polar coordinates. It takes more time to save the AP-formatted data than the IQ-formatted data.

Load. There are two ways to load data.

- Specify the file as a view source.
- Use the utility menu.

Specify the file as a view source.

Specify the file using **File (*.IQ)** or **File (*.AP)** in **Source** of the view menu. The available data is listed in Table 3–20.

NOTE. *The data loaded in this way cannot be zoomed. The data saved in AP-format is unavailable for modulation analysis.*

Table 3–20: Data format available in views

View	Format		Display
	IQ	AP	
Waveform, Analog, FSK, Waterfall, Spectrogram, CDMAWaveform	○	○	–
Polar, CDMAPolar, codePolar, codeWPolar, 3gppPolar, GSMPPolar, CCDF	○	×	–
CDMTime	○ ¹	×	–
EyeDiagram, SymbolTable, EVM	× ²	×	Polar
CodeSpectrogram, CodePower	× ²	×	CodePolar
CodeWSpectrogram, CodeWPower	× ²	×	CodeWPolar
3gppSpectrogram, 3gppPower, 3gppACPView	× ²	×	3gppPolar
CCDFView	× ²	×	CCDF

¹ The data acquired only with the block size of 20 is displayed.

² The file data can not be input directly, but displayed through the view shown in the “Display” column.

Use the utility menu.

1. Display the SaveLoad menu:
 - a. Press the CONFIG:UTILITY key.
 - b. Press the **Util B [SaveLoad]** side key.
 - c. Press the **Load...** side key.
2. Press the **Load From File (*.IQ)** side key and select the IQ-formatted file.

NOTE. *You cannot load AP-formatted data in the analyzer data memory..*

The file access menu appears. Specify the device, directory, and file name. Refer to *Operating File Access Menu* on page 3–178 for detail.

Once you have selected the file, the IQ-formatted data saved in the file is loaded in the memory.

3. Specify **Active** in **Source** of the view menu to display the contents of the data memory.

In this way, you can zoom the waveform if the data has been acquired in the Zoom mode.

Operating File Access Menu

This section describes how to save or load data and copy or delete a file using the file access menu.

Displaying the File Access Menu

The file access menu appears when you press the side key as shown in Figure 3-93 in the CONFIG or VIEW menu.

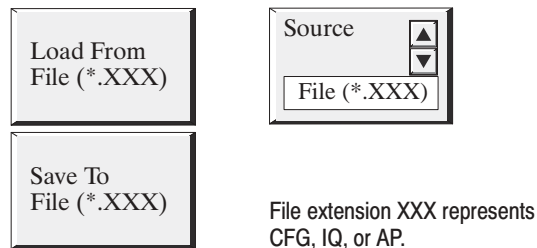

Figure 3-93: Side keys to display the file access menu

The file access menu displays the directory and file listings as illustrated in Figure 3-94 and the menu items as shown in Figure 3-95.

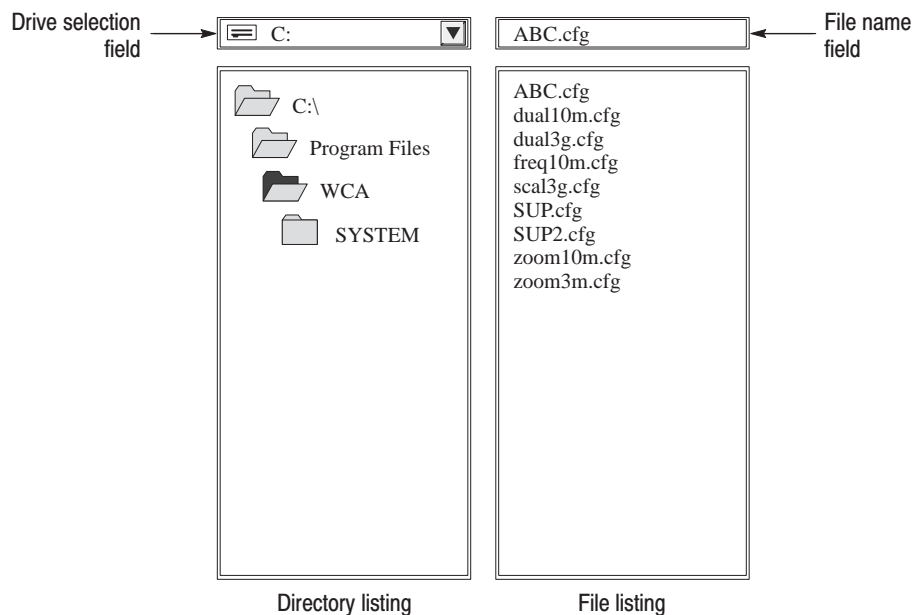

Figure 3-94: Directory and file listings in the file access menu

Cancel	Returns to the previously displayed menu without processing
OK	Execute the save, load, or other operation
File	Select a file from the file listing
Dir	Select a directory from the directory listing
Expand Dir	Display the file listing located in the directory you selected above
Drive	Select the drive in the drive selection field
Name Entry..	Edit the characters in the file name entry field in the subdirectory
Operation...	Open the subdirectory to copy or delete a file, or create or delete a directory

Figure 3-95: File operation menu

Selecting a Drive

1. Press the **Drive** side key. It allows you to select a drive in the drive selection field.
2. Select a drive using the general purpose knob or the ▲ or ▼ key in the ENTRY keypad.

Changing a Directory

1. If necessary, select a drive. Refer to *Selecting a Drive* on page 3–180.
2. Press the **Dir** side key. It allows you to select a directory from the directory listing.
3. Select a directory using the general purpose knob or the ▲ or ▼ key on the ENTRY keypad.
4. Press the **Expand Dir** side key to list the directories under the selected directory.
5. If the directory hierarchy is deep, repeat steps 2 through 4.

Selecting a File

1. If necessary, change the directory. Refer to *Changing a Directory* described above.
2. Press the **File** side key. It allows you to select a file from the file listing.
3. Select a file using the general purpose knob or the ▲ or ▼ key on the ENTRY keypad. The file name you selected is shown in the file name field.

Saving a File

Rewriting an existing file:

1. Select a file using the procedure in *Selecting a File* described above.
2. Press the **OK** side key.

Creating a new file:

1. Press the **Name Entry...** key. The submenu appears.
2. Enter the file name. For detail, refer to *Inputting a Directory or File Name* on page 3–183.
3. Press the **OK** side key.

NOTE. *The analyzer automatically adds the extension to the file. If you input an improper extension, the analyzer replaces it with the proper one.*

Loading a File

1. Select a file using the procedures in *Selecting a File* described above.
2. Press the **OK** side key.

Copying a File

Figure 3–96 shows the Copy File menu.

1. Open the destination directory. Refer to *Changing a Directory* on page 3–180.
2. Select a source file:
 - a. Press the side key **Operation...** and then **Copy File...**. The Copy File menu and file listing boxes appear.
 - b. Select a file using the procedure in *Selecting a File* on page 3–180.
3. Press the **Copy File** side key.
4. Press the uppermost side key twice to return to the top-level menu.

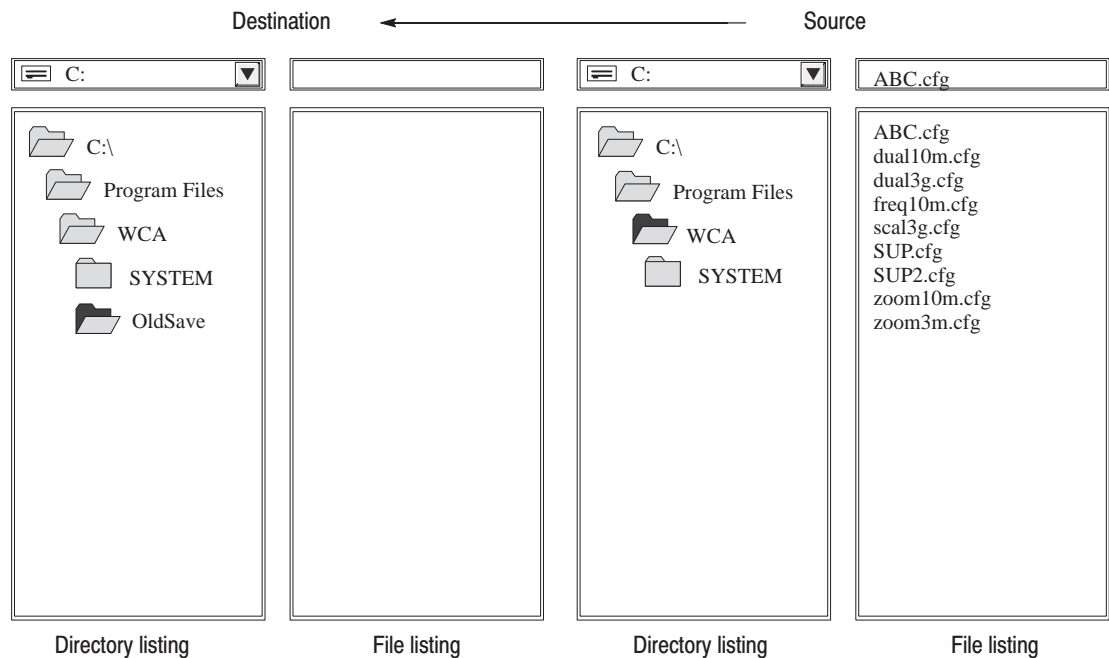

Figure 3–96: Copying a file

Deleting a File

1. Press the side key **Operation...** and then **Delete File...**. The Delete File menu appears.
2. Select a file using the procedure described in *Selecting a File* on page 3–180.
3. Press the **Delete File** side key to delete the file.
4. Press the uppermost side key twice to return to the top-level menu.

Creating a Directory

1. Press the side key **Operation...** and then **Create Dir...**. The Create Dir menu appears.
2. If necessary, change the directory. Refer to *Changing a Directory* on page 3–180.
3. Enter the directory name using the procedure described in *Inputting a Directory or File Name* on page 3–183.
4. Press the **Create Dir** side key to create the directory.
5. Press the uppermost side key twice to return to the top-level menu.

Deleting a Directory

1. Press the side key **Operation...** and then **Delete Dir...**. The Delete Dir menu appears.
2. If necessary, change the directory. Refer to *Changing a Directory* on page 3–180.
3. Press the **Delete Dir** side key to delete the directory.
4. Press the uppermost side key twice to return to the top-level menu.

NOTE. *Directories containing one or more files cannot be deleted.*

Inputting a Directory or File Name

Renaming an existing File. When you select a file from the listing, the name is displayed in the file name field. To create a new file by changing this file name, follow this procedure:

1. Select a file using the procedures described in *Selecting a File* on page 3–180.
2. Press the **Name Entry...** side key.
3. Press the **Position** side key to put the cursor where you want to change.
 - To insert a character, put the cursor immediately after the position where you want to insert the character.
 - To delete the character at the cursor position, press the **Delete Char** side key.
4. Press the desired character side key. For example, if you want to insert “A”, press **A B C D E F G H...** → **A**.
5. If necessary, repeat the steps 3 and 4.

Inputting a New Name. If the file name is not shown in the file name field or if you want to enter a new name, follow this procedure:

1. Press the **Name Entry...** side key.

If the file name field contains characters, press the **Delete Char** side key to delete them.
2. Press the desired character side key. For example, if you want to insert “A”, press **A B C D E F G H...** → **A**. Repeat this step to complete the name.
 - To change a character, press the **Position** side key and then turn the general purpose knob to position the cursor at the character you want to change.
 - To delete a character at the cursor position, press the **Delete Char** side key. While the cursor is on the space, the **Delete Char** side key works as the Backspace key.

Data File Format

This section describes the structure of data files (*.AP, *.IQ).

File Structure

In the frequency domain mode, the analyzer makes only frequency domain data files. In the dual domain mode, the analyzer makes frequency domain data files and time domain data files (“T” is added to the end of frequency domain file name) simultaneously.

The data file normally consists of three blocks (see Figure 3–97).

Data file (*.AP, *.IQ)

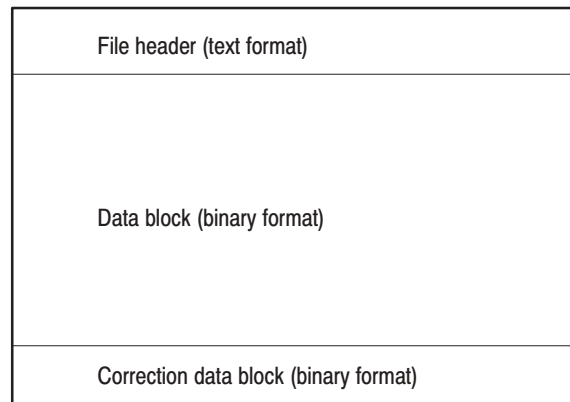

Figure 3–97: Data file structure

When logging data continuously, a data block is added every data acquisition, and the date and time are added to the end of data file in the text format.

The data file is normally made after a data acquisition completes. When logging data, the analyzer acquires data and adds the data block to the file repeatedly. So, at the time the analyzer creates the file header, it does not know when it will acquire the last frame. Therefore, the analyzer adds the date and time to the end of file when the logging completes. Check if the date and time are added. If so, use them instead of *DateTime* in the file header. Refer to *DateTime* on page 3–188 for the format of date and time.

Also, when logging data, the analyzer does not know the number of valid frames (*ValidFrames*; refer to page 3–188) at the time it creates the file header. Then the analyzer writes “*ValidFrames=0*” supposedly. Check the value of *ValidFrames* in the file header. If it is zero, obtain the true value by investigating the file size. In this case, Correction data block is always added.

The details on each block are described on the following page.

File Header

The following is an example of the file header. The analyzer always writes “xxxxxType” at the beginning of header, where x is a decimal digit. For other items, no special order is observed, and some new items may be added.

```

40403Type=WCA380AP
FrameReverse=Off
FramePadding=Before
Band=RF4
IFMode=HiRes
MemoryMode=Dual
FFTType=SW
FFTWindow=Blackman
ENBW=2
FFTPoints=1024
Bins=801
MaxInputLevel=0
LevelOffset=0
CenterFrequency=7.9G
FrequencyOffset=0
Span=5M
BlockSize=40
ValidFrames=40
FramePeriod=160u
UnitPeriod=80u
FrameLength=160u
DateTime=2000/03/24@10:45:01
GainOffset=-72.532
MultiFrames=1
MultiAddr=0

```

The first numbers show a length of header. The first character “4” in the example indicates that the length of header is expressed by the four bytes after the second character. In this case,

$$\text{Length of header} = 1 \text{ (1st byte)} + 4 \text{ (2nd to 5th bytes)} + 0403 = 408 \text{ bytes}$$

The data block starts from the 409th byte.

Type. Shows a type of data. The analyzer has the following four types of data.

WCA380IQ indicates the data block contains I and Q data in the frequency domain.

WCA380IQT indicates the data block contains I and Q data in the time domain.

WCA380AP indicates the data block contains amplitude and phase data in the frequency domain.

WCA380APT indicates the data block contains amplitude and phase data in the time domain.

NOTE. When *FFTType* is set to *SW* (refer to page 3–186), data files in the frequency domain contain the AP format data (*Type* = *WCA380AP*) even if the file extension is “.IQ”.

FrameReverse. Shows the frame order in a data block.

Off indicates the last frame in the data block is the latest acquired frame.

On indicates the first frame in the data block is the latest acquired frame.

FramePadding. The analyzer adds dummy frames when acquired frames do not fill the data block. Such a case occurs, for example, when the analyzer stops a data acquisition after a trigger event before it fill a pre-trigger area in the data block with frames. See Figure 3–98.

Before adds dummy frames before valid frames, but not in the first block.

After adds dummy frames after valid frames, but not in the last block.

FFTType. Shows the FFT type, HW (hardware) or SW (software), when the analyzer acquired the data.

FFTWindow. Shows the FFT window setting when the analyzer acquired the data.

ENBW. Shows the factor used for the in-band power calculation.

FFTPoints. Shows the FFT points setting when the analyzer acquired the data.

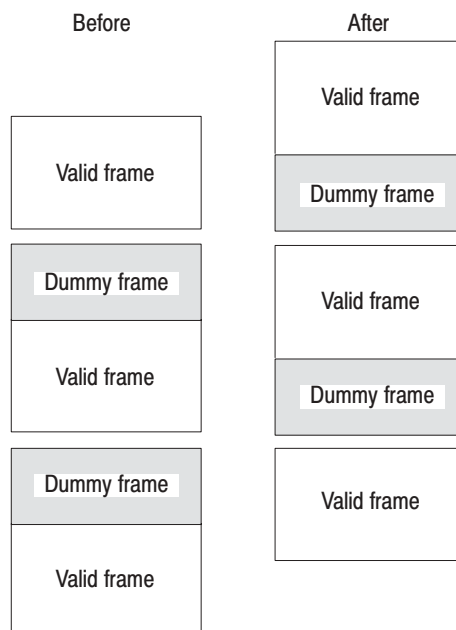

Figure 3–98: Frame padding

Bins. Shows the number of bins. It is the same as “bins” in the frame header (refer to *Frame Header* on page 3–189). For the relation between the number of bins and the frame size, refer to *Frame Data* on page 3–191.

MaxInputLevel. Shows the reference level in dBm when the analyzer acquired the data.

LevelOffset. Shows the level offset in dB when the analyzer acquired the data.

Band. Shows the input frequency band when the analyzer acquired the data. It is necessary only when the analyzer reloads the data.

IFMode. Shows the IF (Intermediate Frequency) mode when the analyzer acquired the data. It is necessary only when the analyzer reloads the data.

MemoryMode. Shows the memory mode when the analyzer acquired the data. It is necessary only when the analyzer reloads the data.

CenterFrequency. Shows the center frequency in Hz when the analyzer acquired the data.

FrequencyOffset. Shows the frequency offset in Hz when the analyzer acquired the data.

Span. Shows the span in Hz when the analyzer acquired the data.

BlockSize. Shows the block size when the analyzer acquired the data.

ValidFrames. Shows the number of frames in the data block. This value divided by MultiFrames (described below) represents the number of frames that are scanned and synthesized into one frame.

FramePeriod. Shows the frame period setting in second. The actual period is obtained by multiplying UnitPeriod (described below) by the difference of “ticks” of each frame (refer to page 3–191).

UnitPeriod. Shows the unit time of time stamp “ticks” of each frame (refer to page 3–191).

FrameLength. This shows the time necessary to acquire one frame.

DateTime. Shows the time when the analyzer acquired the last frame in a data block. It is recommended to change “@” to “ ” (space). Files may have many “@” characters.

GainOffset. Shows the gain offset. It is used for calculating the amplitude (refer to page 3–193).

MultiFrames. Shows the number of scans for creating one frame in the multi-frame mode. For example, when MultiFrames = 20, scanning 20 times with the span of 5 MHz make the span of 100 MHz.

MultiAddr. Shows the last frame address in the multi-frame mode. The range is 0 to MultiFrames –1. MultiFrames –1 indicates that the data ends just at the end of scans.

Data Block

Each data block contains frame header and frame data pairs. The number of frames in a block is indicated by ValidFrames (refer to page 3–188). The frame order is determined by FrameReverse (refer to page 3–186).

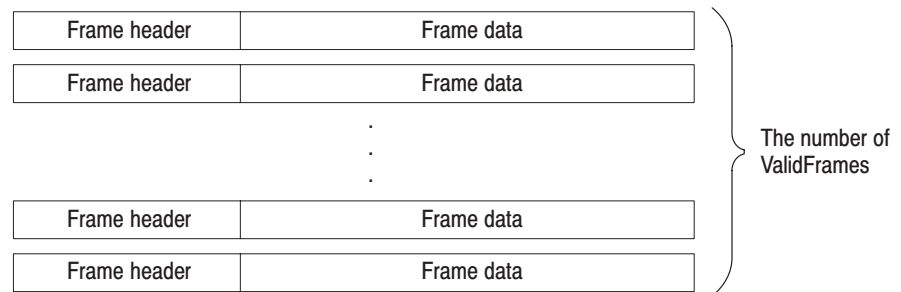

Figure 3–99: Data block structure

Frame Header The frame header is defined as the following structure.

```
structframeHeader_st {
    short dataShift;
    short validA;
    short validP;
    short validI;
    short validQ;
    short bins;
    short frameError;
    short triggered;
    short overLoad;
    short lastFrame;
    unsigned long ticks;
};
```

The explanation for each item listed above begins on the following page.

short dataShift. The lower four bits have the value 0 to 15. The upper 12 bits are uncertain. It is used to calculate I and Q values (refer to *Calculation of Data* on page 3–193).

short validA, short validP, short validI, short validQ. These parameters indicate whether the data type is amplitude, phase, I, or Q, respectively. Table 3–21 shows possible combinations of these values.

0 indicates that data is not written in the file.

-1 indicates that data is written in the file.

Table 3–21: Possible combinations of data types

validA	validP	validI	validQ
0	0	0	0
-1	0	0	0
0	-1	0	0
-1	-1	0	0
0	0	-1	0
0	0	0	-1
0	0	-1	-1

short bins. Shows the number of bins. It is the same as Bins in the file header.

short Reserved. Internal use only.

short triggered. Indicates whether the frame is before or after the trigger.

0 indicates that the frame is before the trigger (pre-trigger).

-1 indicates that the frame is after the trigger (post-trigger).

short overLoad. Indicates whether an input overload occurred.

0 indicates that the MaxInputLevel value in the file header was proper.

-1 indicates that the MaxInputLevel value in the file header was too low.

short lastFrame. The analyzer can divide its memory such as 100 frames \times 40 blocks. “lastFrame” indicates the last frame in a block.

0 indicates that the frame is not the last in the block.

-1 indicates that the frame is the last in the block.

unsigned long ticks. Shows a time stamp with the unit time of UnitPeriod in the file header (not FramePeriod).

Frame Data

A frame contains either pairs of amplitude and phase data or pairs of I and Q data. In the case of amplitude data only, the format is the same as in the case of pairs. The frame size depends on Bins in the file header (or bins in the frame header) as listed in Table 3–22.

Table 3–22: Frame size

Value of Bins	Number of data per frame
121, 161, 201	256 bins per frame
481, 501, 641, 751, 801	1024 bins per frame

Order of Bins. The frequency domain data line from the center frequency data and dummy data are inserted as given in Table 3–23.

Table 3–23: Order of bins in frequency domain

Number of bins	Order of bins
121	60, 61, 62, ..., 118, 119, 120, <135 dummy data>, 0, 1, 2, ..., 57, 58, 59
161	80, 81, 82, ..., 158, 159, 160, <95 dummy data>, 0, 1, 2, ..., 77, 78, 79
201	100, 101, 102, ..., 198, 199, 200, <55 dummy data>, 0, 1, 2, ..., 97, 98, 99
481	240, 241, 242, ..., 478, 479, 480, <543 dummy data>, 0, 1, 2, ..., 237, 238, 239
501	250, 251, 252, ..., 498, 499, 500, <523 dummy data>, 0, 1, 2, ..., 247, 248, 249
641	320, 321, 322, ..., 638, 639, 640, <383 dummy data>, 0, 1, 2, ..., 317, 318, 319
751	375, 376, 377, ..., 748, 749, 750, <273 dummy data>, 0, 1, 2, ..., 372, 373, 374
801	400, 401, 402, ..., 798, 799, 800, <223 dummy data>, 0, 1, 2, ..., 397, 398, 399

Definition of Bin. The bin is defined as the following structure.

AP-format data

```
struct apBin_st{
    short a;
    short p;
};
```

IQ-format data

```
struct iqBin_st{
    short q;
    short i;
};
```

Definition of frame. The frame is defined as the following structure.

AP format (1024 bins)

```
struct apFrame1024_st {
    struct apBin_st ap[1024];
};
```

IQ format (1024 bins)

```
struct iqFrame1024_st{
    struct iqBin_st iq[1024];
};
```

AP format (256 bins)

```
struct apFrame256_st{
    struct apBin_st ap[256];
};
```

IQ format (256 bins)

```
struct iqFrame256_st{
    struct iqBin_st iq[256];
};
```

Calculation of Data. All the data of amplitude, phase, I, and Q are transformed to 2-byte signed integers, then written on the file.

Amplitude

For the APT or AP file, the amplitude is calculated using a with this formula.

$$\text{Amplitude} = a/128 + \text{GainOffset} + \text{MaxInputLevel} \text{ [dBm]}$$

For the IQT file, the amplitude is calculated using i and q with this formula.

$$\text{Amplitude} = 10 * \text{Ln}(i*i + q*q) / \text{Ln}(10) + \text{GainOffset} + \text{MaxInputLevel} \text{ [dBm]}$$

For the IQ file, the amplitude is calculated using i and q with this formula.

$$\text{Amplitude} = 10 * \text{Ln}((i*i + q*q) / (1 << ((\text{DataShift} \& 0xF) * 2))) / \text{Ln}(10) + \text{GainOffset} + \text{MaxInputLevel} \text{ [dBm]}$$

Phase

For the APT or AP file, the phase is calculated using p with this formula.

$$\text{Phase} = p/128 \text{ [degree]}$$

For the IQT or IQ file, the phase is calculated using i and q with this formula.

$$\text{Phase} = \text{atan2}(q, i) * (180/\text{pi}) \text{ [degree]}$$

I, Q

For the IQT file, I and Q are calculated with this formula.

$$\text{IQScale} = \text{Sqrt}(\text{Power}(10, (\text{GainOffset} + \text{MaxInputLevel})/10)/20*2)$$

$$I = i * \text{IQScale} \text{ [V]}$$

$$Q = q * \text{IQScale} \text{ [V]}$$

For the IQ file, I and Q are calculated with this formula.

$$\text{IQScale} = \text{Sqrt}(\text{Power}(10, (\text{GainOffset} + \text{MaxInputLevel})/10)/20*2)$$

$$I = i / (1 << \text{DataShift}) * \text{IQScale} \text{ [V]}$$

$$Q = q / (1 << \text{DataShift}) * \text{IQScale} \text{ [V]}$$

Correction Data Block

The correction data block contains gain and phase correction data as one frame in the frequency domain. When this block is added, the amplitude and phase are calculated with the following formula. Be careful about the sign for phase correction.

$$\text{Amplitude} = (\text{Original data}) - (\text{Gain correction data}/128) \text{ [dBm]}$$

$$\text{Phase} = (\text{Original data}) + (\text{Phase correction data}/128) \text{ [degree]}$$

Using Windows 98

The analyzer operates under Windows 98. You can switch to a Windows 98 desktop screen or execute a Windows 98 application program if necessary.

You can operate the analyzer only with a mouse. For detail, refer to Appendix E.

Attaching a Mouse and a Keyboard

You must attach a mouse and a keyboard to the analyzer before you can access Windows 98.



CAUTION. *Be sure that the power is off before you attach a mouse or a keyboard. When power is on, you must place the power switch on the front panel in the off position and wait for power-down.*

Figure 3-100 shows the locations of connectors on the rear panel. The connectors for a PS/2 mouse and a keyboard are located on the second slot from the right.

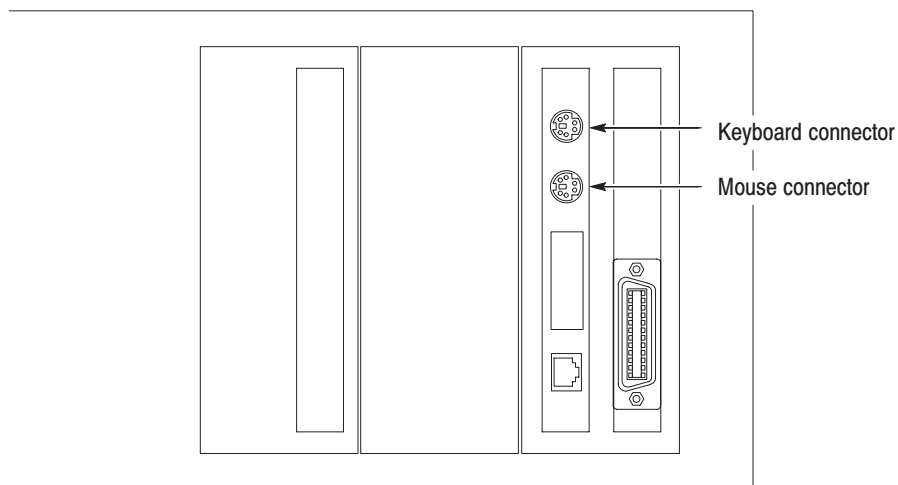

Figure 3-100: Mouse and keyboard connectors

Attach a mouse and a keyboard to connectors.

Instead of using numerical keys on the front panel of the analyzer, use the keyboard to select items or enter values. Table 3–24 shows the valid keys:

Table 3–24: Functions available with a keyboard

Key	Purpose	Descriptions
Numeric keys	Numeric input	Inputs numbers in a numeric field.
Arrow keys	Moving the caret	Moves the caret within a numeric field.
	Selecting an item	Upper or left arrow allows you to select the menu item placed just above the currently selected item. Lower or right arrow allows you to select the menu item placed just below the currently selected item.
Back Space	Deleting an item	Deletes one character positioned just before the caret.
Delete	Deleting an item	Deletes one character positioned just after the caret.
ESC	Numeric input	Clears text in the input field.
ENTER	Numeric input	Establishes the value in the input field to the analyzer.
K and k keys	Numeric input	Both keys represent k (10^{+3}). Be sure to press the ENTER key after the K or k.
M and m keys	Numeric input	Represent M (10^{+6}) and m (10^{-3}), respectively. Be sure to press the ENTER key after the M or m.

Accessing Windows 98

When you attach a mouse and a keyboard and power on the analyzer, a pointer appears on the screen. You can start a Windows 98 application or switch to a Windows 98 desktop screen if necessary.

Starting Windows Applications

When you use a mouse to move the pointer to the bottom of the screen, the task-bar appears. The task-bar shows **Start** and the name of the analyzer application (e.g. WCA380). Following the Windows 98 operating procedure, access a Windows application from **Start**.

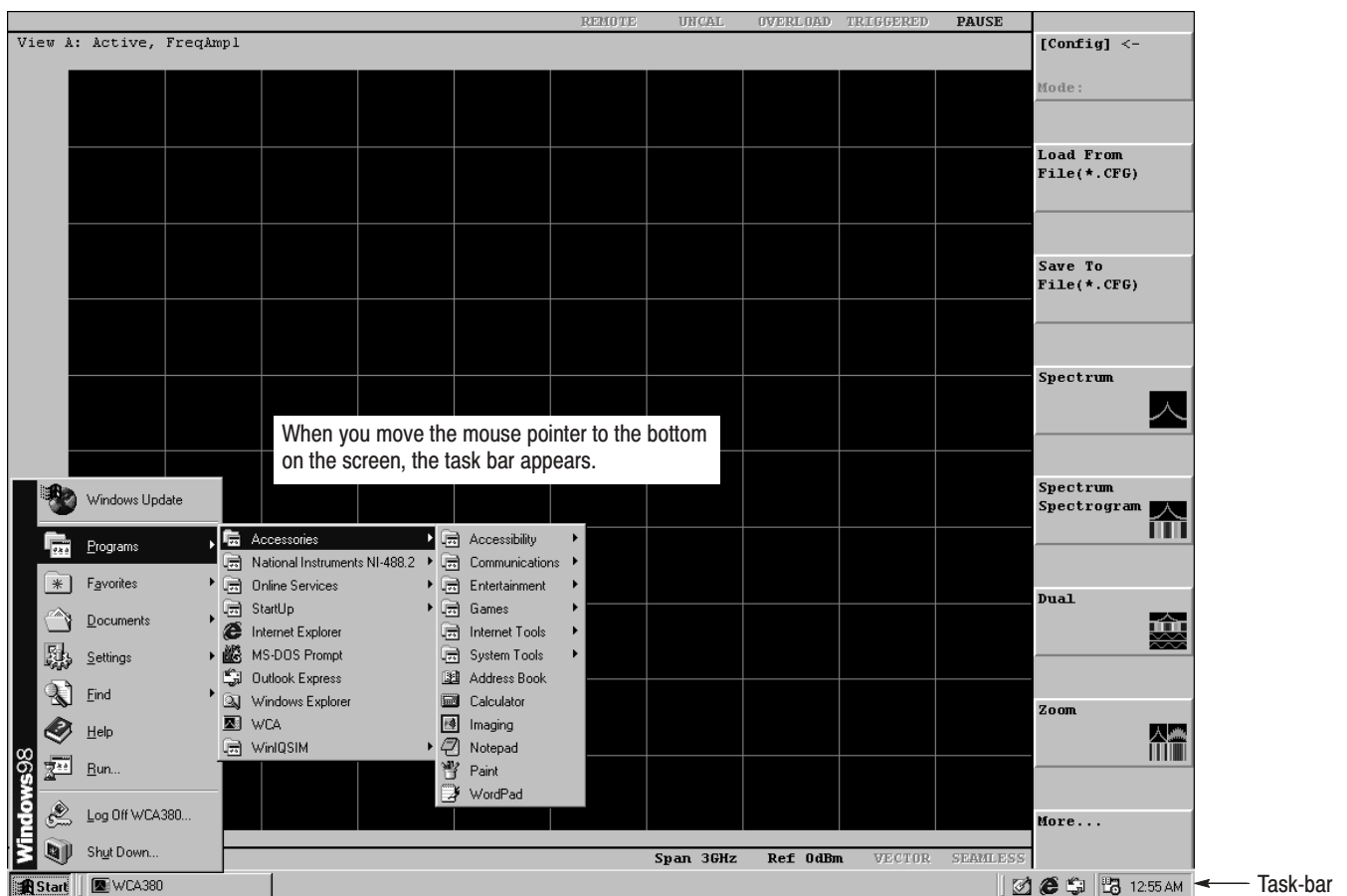

Figure 3-101: Displaying the Windows 98 accessory menu

Setting Date and Time. The analyzer view displays date and time managed by the Windows operating system. You can use the Windows 98 time setting program to set date and time.

Displaying the Windows Desktop Screen

To display a Windows98 desktop screen, follow these steps:

1. Use a mouse to move the pointer to the bottom of the display (see Figure 3-101). The task bar appears.
2. Locate the pointer on the **WCA330** or **WCA380** icon in the task bar and right-click. A menu appears.
3. Select **Close** in the menu. The system program of the analyzer terminates and a Windows 98 desktop screen appears.

Switching to View Display. To switch the Windows 98 desktop screen to the analyzer view display, do the following step:

- Select **Start** → **Program** → **WCA** from the task bar. The system program of the analyzer starts.

LAN Connection

The analyzer is equipped with the standard LAN Ethernet interface. You can share resources such as files or disks by connecting the analyzer to your network.

You can also control the analyzer from other PC's via LAN. For details on remote control, refer to the Programmer Manual.

Attaching a Cable

Figure 3–102 shows the location of connectors on the rear panel. The connector at the bottom in the second slot from the right is an Ethernet 10/100 BASE-T connector. Attach a twisted-pair cable to this connector.

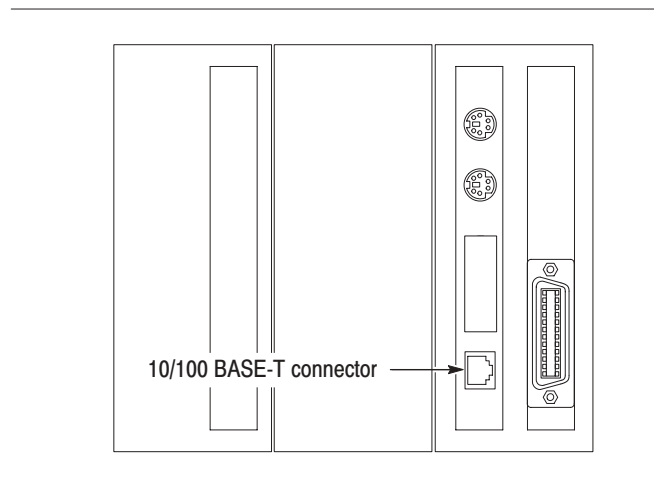

Figure 3–102: 10/100 BASE-T connector location (rear panel)

If you reboot the analyzer after connecting to LAN, the analyzer detects the network speed automatically and sets it to 10 Mbps or 100 Mbps.

Network Setting

You can use the Network dialog box in the Windows 98 Control Panel to set network parameters. You must set network parameters, such as an IP address, as appropriate to your operating environment. Contact your system administrator for how to set these parameters.

Sharing Resources

If you connect the analyzer to LAN, you can share resources such as files and disks on the network.

To share resources, open **Properties** dialog box for each resource such as files or disks and enter necessary information on the **Sharing** tab. Figure 3–103 shows a setting example to share a folder.

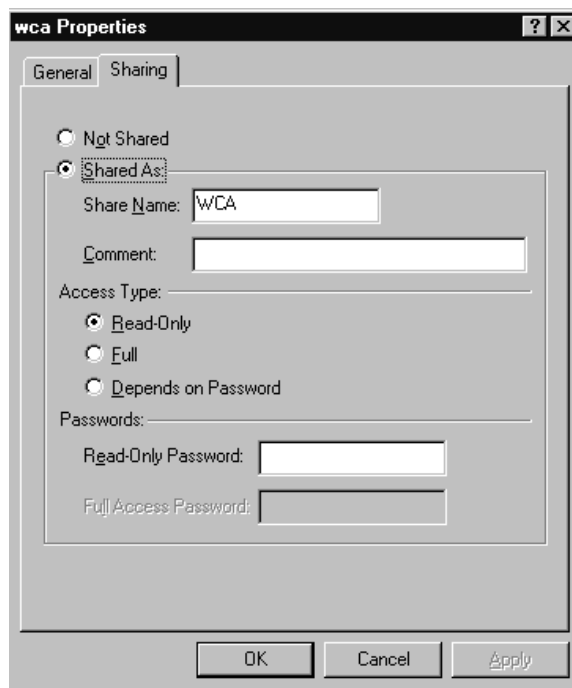

Figure 3–103: Setting for sharing a folder

Outputting Waveform Data

You can output the data acquired in the analyzer to a printer, hard disk, and floppy disk, in a screen hardcopy or text format for use in other applications such as creating a report with a word processor.

- Screen hard copy page 3-202
- Outputting view data in text format page 3-206

Screen Hardcopy

You can make a hardcopy to a printer. The Windows 98 application allows you to make a screen capture as a bit-map file and store the file on a hard disk or a floppy.

Outputting Data to a Printer

Before you can print a hardcopy, you have to connect a printer to the analyzer. In addition, you have to install the printer driver and set the default printer.

NOTE. For the optional HP970Cxi printer, the printer driver is factory installed. For the optional accessories, refer to Appendix A.

Connecting the Printer. Plug the printer cable into the rear panel parallel port.



CAUTION. Be sure that power is off before you connect a cable. When power is on, you must place the power switch on the front panel in the off position and wait for power-down.

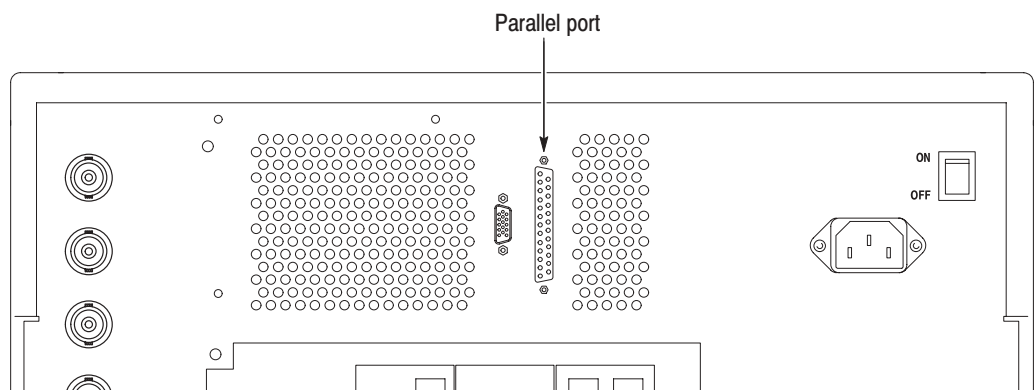

Figure 3-104: Parallel port location (rear panel)

If you have connected the analyzer to LAN, you can also use any printer on the network.

Installing the Printer Driver. Install the printer driver according to the Windows 98 printer wizard. You need a mouse to install the driver. For connecting the mouse, refer to page 3–195.

NOTE. For the optional HP970Cxi printer, the printer driver is factory installed

1. Move the mouse pointer to the bottom on the screen. The Windows 98 task-bar appears.
2. Open **Start** → **Settings** → **Printer** → **Add Printer**. The dialog box appears as shown in Figure 3–105.
3. Install the printer driver following the messages appearing in the dialog box.

NOTE. You can set the default printer when you install the driver.

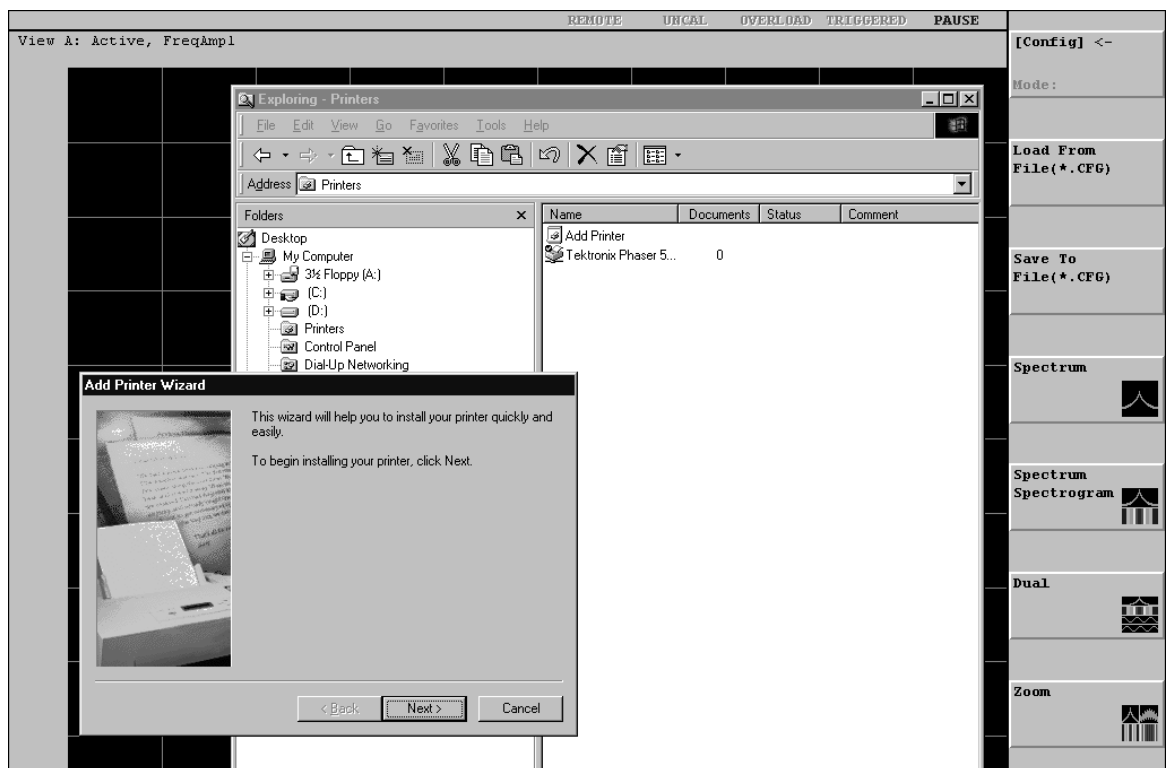

Figure 3–105: Installing the printer driver

Setting the Printer Property. If you want to set the printer property such as the paper size, follow these steps:

1. On the Windows 98 desktop, double-click **My Computer** → **Printers** and click the printer icon that you use.
2. Right-click on the printer icon and select **Properties** from the menu.
3. Click on any of the tabs in the **Properties** window to view and make selections that control the printer features. For example, the **Paper** tab controls **Paper size** and **Paper source** selections.

Return to the View Display. When you switch the display from the Windows 98 desktop to the analyzer view, do this step:

- From the task bar, select **Start** → **Program** → **WCA** to start the analyzer system program.

Print. Perform the following procedure to make a hardcopy.

1. With signal acquisition at a stop, press the **PRINT** key on the front panel. The Print menu appears on the screen.
2. Press the **Printer** side key to select the printer. If you use the optional HP970Cxi printer, select **HP DeskJet 970 Series**.
3. Press the **Print To Printer** side key to transfer the whole screen image data to the printer.

If you want to cancel the print, press the **Cancel** side key to back to the previous menu.

If you have not set the default printer yet, the analyzer displays the message “Default Printer Not Found” in red in the uppermost status display area on the screen. This message also appear when no printer driver is installed.

If the printer is disconnected or turned off, the printer driver prompts you to correct the problem.

**Outputting the Hardcopy
to a Disk**

A screen image can also be output as a bit-map file to a hard disk or floppy disk. You can use it for use with desktop publishing (DTP) software to create a report.

1. Press the **PRINT** key on the front panel.
2. Press the **Save To File (*.BMP)** side key.
The directory and file listings appear.
3. Select an existing file or create a new file.
For details, refer to *Operating File Access Menu* on page 3-178.
4. Press **OK** side key.

Outputting View Data in Text Format

You can output acquired data as text data to a file or the Windows clipboard in order to generate a spreadsheet program and create a report; transfer the data to other equipment and analyze the spectrum in detail; or use it as test data for the next-stage product.

Restrictions The following views can output acquired data in the text format:

- Waveform
- Analog
- FSK
- CDMAWaveform
- EVM
- 3gppACPView
- SymbolTable

In the Waveform and CDMAWaveform views, the data must be acquired with span \leq 50 MHz.

Output Format The following is an example of spectrum data output to a file. The left column contains the data along the horizontal axis, and the right column contains the data along the vertical axis. They are separated by a tab character.

```

0           -10.1942459427812
7.8125E-8   -15.5797318785542
1.5625E-7   -15.9940859783336
2.34375E-7  -15.5557856085716
3.125E-7    -15.9780353894513
3.90625E-7  -15.7083613241091
4.6875E-7   -15.7874987521482
5.46875E-7  -15.7419274821247
6.25E-7     -16.2202259114158
7.03125E-7  -15.618887152088
. . .
    
```

The units of measure of the vertical and horizontal axes data is what is currently displayed on screen. The number of data points output to the file or the clipboard equals the currently set number of FFT points in the time domain, or the number of bins in the frequency domain.

Figure 3–106 shows waveform data that has been pasted in the application software Scratch Pad.

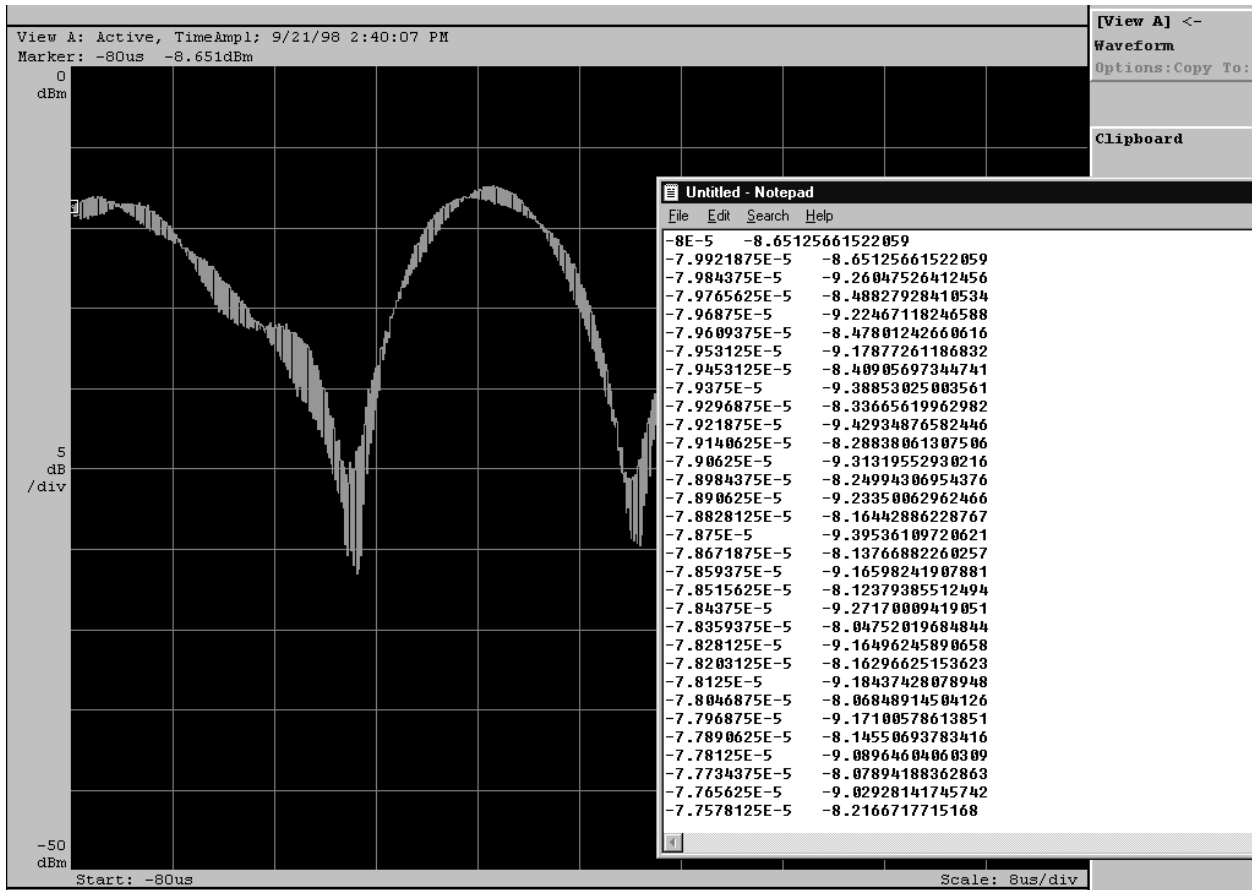

Figure 3-106: Pasting text data of the spectrum

Text Output Procedure

Follow this procedure to output the text data to the clipboard or a file:

1. Display the waveform in the view. Refer to *Restrictions* on page 3-206.
2. If necessary, change the display frame.
3. Do either step using the view menu:
 - To output the data to the clipboard:
Press the side key **Options...** → **Copy To...** → **Clipboard**.
 - To output the data to a file:
Press the side key **Options...** → **Copy To...** → **Text File**.
For details on the file access menu operations, refer to page 3-178.

Using the Text Data in an Application Software

Perform the following procedure to use the text data of the spectrum in an application software such as Scratch Pad or Microsoft Excel. You can use a similar procedure for other applications.

1. Copy the text data to the clipboard with the procedure described just above.
2. Start the application.
3. Select **Paste** from the Edit menu, or press the **Ctrl** and **V** keys together on the keyboard. The contents of the clipboard are pasted.
4. When you save the file, select **Save As...** from the File menu. Input the file name and then click on **OK**.

Figure 3–107 shows a graph created in Microsoft Excel using the text data of the spectrum.

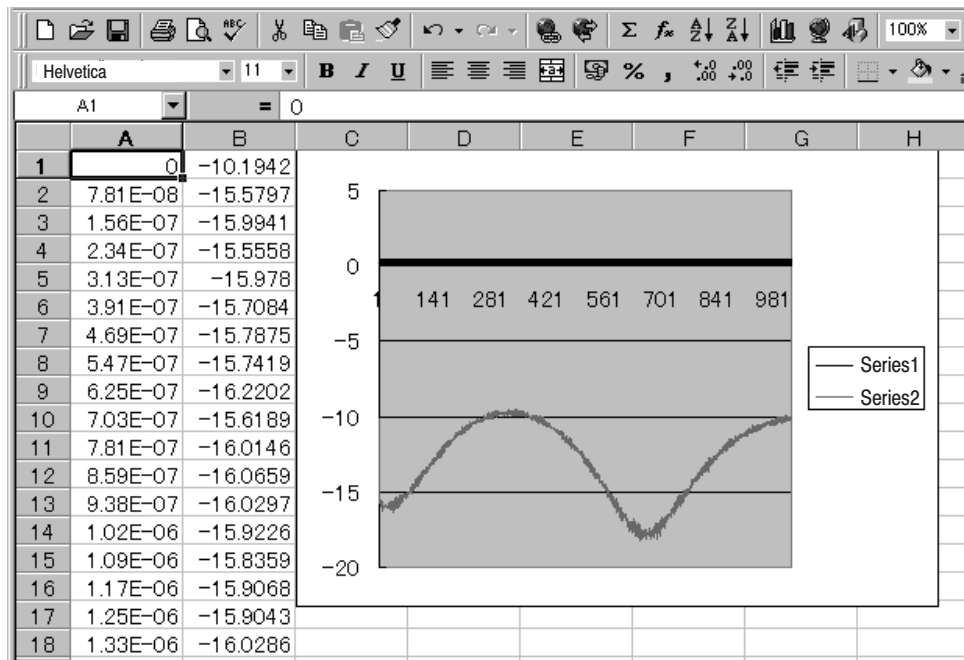

Figure 3–107: Creating a graph from the text data in Excel

Setting the Date and Time

The analyzer displays the system-managed date and time in each view. You can change the date, time, and time zone using the Windows 98 date and time setting application from the front panel.

1. Press CONFIG:UTILITY key on the front panel.
2. Press **Action** side key and select **Assign**.
3. Press **UTIL D** side key and select **TimeDate**.

The Date/Time Properties dialog box appears.

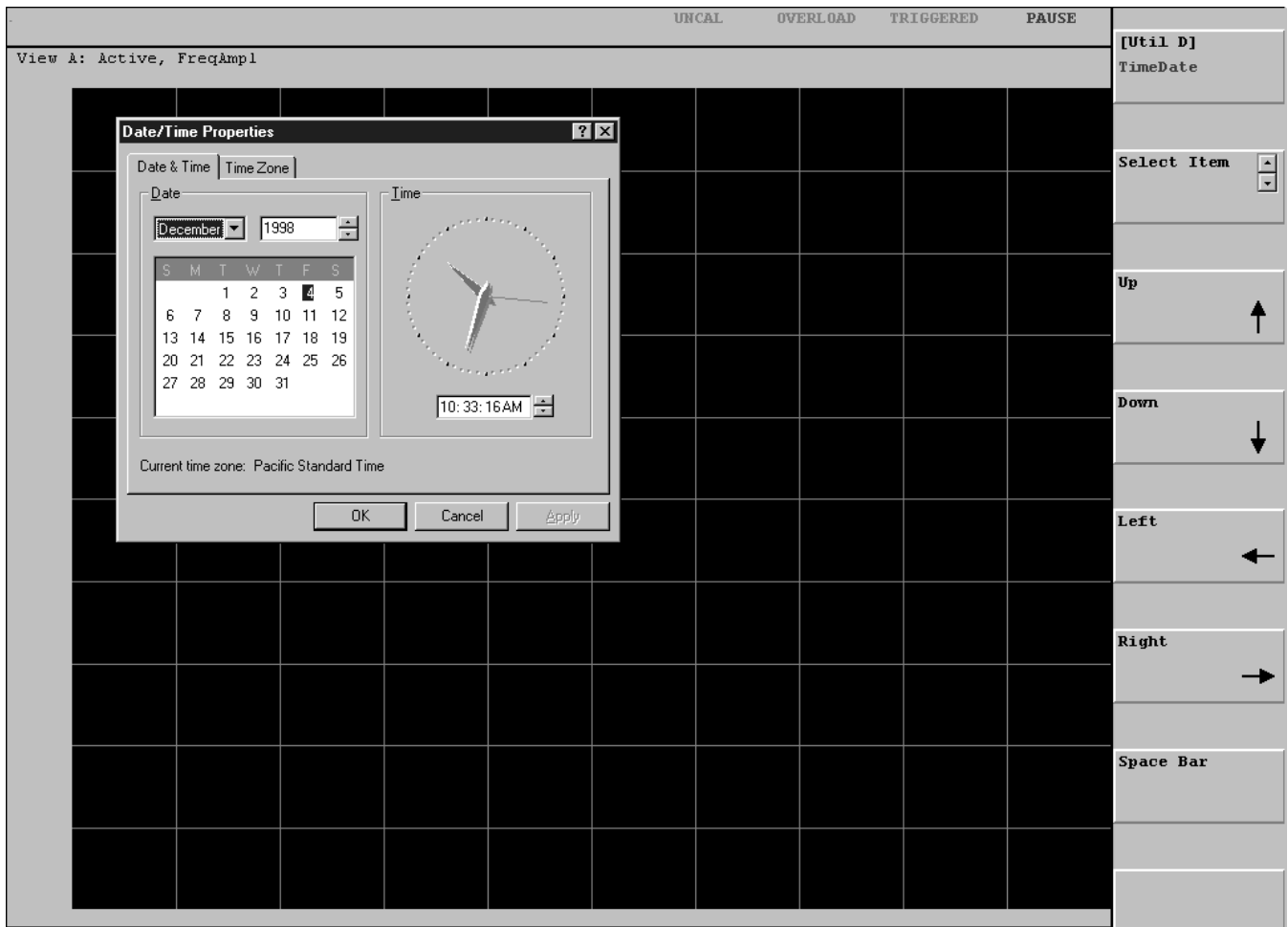

Figure 3-108: Date/Time Properties dialog box

4. Change the date and time with the following substeps. If you want to change the time zone, skip to the step 5.
 - a. Using the general purpose knob, move the cursor to select the field.
 - b. Change the value with the arrow (↑, ↓, ←, →) side keys.
 - c. Repeat substeps **a** and **b** until you set all the fields.
5. Change the time zone with the following substeps, or skip to the step 6.
 - a. Move the cursor to the Time & Date tab using the general purpose knob, and press the right arrow (→) key to select the Time Zone tab.
 - b. Using the general purpose knob, move the cursor to select the field.
 - c. Change the value with the arrow (↑, ↓, ←, →) side keys. To select the check box, use the **Space Bar** side key.
6. When you are finished, move the cursor to the **OK** button using the general purpose knob, and press the **Space Bar** side key to confirm your settings.

The Date/Time Properties dialog box appears again.
7. Press **UTIL D** side key and select **None** to close the Date/Time Properties dialog box.

Displaying the Version and Self Test Result

The analyzer executes the self test and displays the result at power up (see Figure 3–109). The display also contains the version information of the system software. You can see the contents at any time after power up of the analyzer.

To display the version and self test result, perform these steps:

1. Press any key in the CONFIG area on the front panel.
For example, press the CONFIG:MODE key.
2. Press the uppermost side key.

```
WCA380 WIRELESS COMMUNICATION ANALYZER
Copyright (C) 2000 SONY/TEKTRONIX CORPORATION

Main System:
  Version:      3.11

Sub System:
  Version:      4.1
  Rom:          Pass
  Ram:          Pass
  A20:          Installed

Options:
```

Figure 3–109: Displaying the version and self test result (view of upper left corner)

The display shows the following information:

- Version
 - Main System: Basic application software version
 - Sub System: Firmware version

- Self test result

The self test runs for the ROM, RAM, and A20 (digital down converter) board. The result is shown with “Pass” or “Fail” for the ROM and RAM and “Installed” or “Not installed” for the A20 board.

Note that the analyzer cannot be checked sufficiently with this self test. If you suspect that the analyzer operates abnormally, contact your local Tektronix distributor or sales office.

- Optional information

If any optional software is installed, it is indicated with its version.

Appendices





Appendix A: Options and Accessories

This appendix describes the various options as well as the standard and optional accessories that are available for the analyzer.

Options

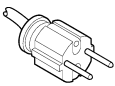
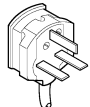
Table A-1 list the options available when ordering this product.

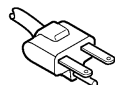
Table A-1: Options

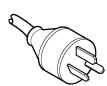
	Option #	Label	Description
	A1	Universal European power cord	230 V, 50 Hz power cord Fuse 5A (T) (IEC 127) Fuse Cap Cable Retainer
	A2	UK power cord	230 V, 50 Hz power cord Fuse 5A (T) (IEC 127) Fuse Cap Cable Retainer
	A3	Australian power cord	240 V, 50 Hz power cord
	A4	North American power cord	220 V, 60 Hz power cord
	A5	Switzerland power cord	220 V, 50 Hz power cord
	AC	China power cord	220 V, 10A, 50 Hz power cord
	A99		No power cord
	1R	Rackmount	Spectrum Analyzer comes configured for installation in a 19 inch wide instrument rack. For later field conversions, order kit # 016-1754-XX.

Standard Accessories

The analyzer comes standard with the accessories listed in Table A–2.

Table A–2: Standard accessories

Accessory	Part number
User manual	070-A752-XX
Programmer manual	070-A754-XX
U.S. power cord	161-0066-XX
Keyboard	119-B061-XX
Mouse	119-B063-XX
BNC–N adapter	103-0045-XX

Optional Accessories

You can also order the optional accessories listed in Table A–3.

Table A–3: Optional accessories

Accessory	Part number
Service manual	070-A755-XX
Rack mount kit (for field conversion)	016-1754-XX
Data display and analysis software for PC	SL7PCW3



Appendix B: Specifications

This appendix lists the electrical, physical, and environmental characteristics of the analyzer, and specifies the performance requirements for those characteristics. The specifications are common to the WCA330 and WCA380, unless otherwise noted.

Electrical Characteristics

Unless otherwise stated, the following tables of electrical characteristics and features apply to the spectrum analyzer after a 20 minute warm-up period (within the environmental limits) and after all normalization procedures have been carried out.

Table B-1: Frequency

Characteristic	Description
Input frequency	Baseband DC to 10 MHz RF/RF1 band 10 MHz to 3 GHz (RF: WCA330, RF1: WCA380) RF2 band 2.5 GHz to 3.5 GHz (WCA380) RF3 band 3.5 GHz to 6.5 GHz (WCA380) RF4 band 5.0 GHz to 8.0 GHz (WCA380) I/Q input DC to 16 MHz
Center frequency setting resolution	0.1 Hz
Residual FM	2 Hz p-p
Reference frequency	
Aging per day	1×10^{-9} (after 30 days of operation)
Aging per year	1×10^{-7} (after 30 days of operation)
Temperature drift	1×10^{-7} (10° C to 40° C)
Total frequency error	2×10^{-7} (within one year after calibration)
Reference output level	>0 dBm
External reference input	10 MHz, -10 to +6 dBm

Table B-2: Spectrum purity

Characteristic	Description
Spectrum Purity	RF attenuation = 0 dB
Frequency = 1500 MHz Carrier offset = 10 kHz	100 dBc/Hz (Normal IF mode) 95 dBc/Hz (HiRes IF mode)
Frequency = 1500 MHz Carrier offset = 100 kHz	103 dBc/Hz (Normal IF mode) 105 dBc/Hz (HiRes IF mode)
Frequency = 1500 MHz Carrier offset = 1 MHz	120 dBc/Hz (Normal IF mode) 125 dBc/Hz (HiRes IF mode)

Table B-3: Input

Characteristic	Description
Signal input	
Input connector	N type (except IQ input); BNC type (IQ input)
Input impedance	50 Ω
VSWR	<1.5 (2.5 GHz, RF attenuation \geq 10 dB) <2.0 (7.5 GHz, RF attenuation \geq 10 dB, WCA380 only)
Maximum Input Level	
Maximum DC voltage	0 V (RF for WCA330, RF1 to RF4 for WCA380) \pm 5 V (Baseband) \pm 5 V (IQ input)
Maximum input power	+30 dBm (RF for WCA330, RF1 to RF4 for WCA380)
Attenuator	
RF attenuator	0 to 50 dB (10 dB step) 0/2/5/7 dB (RF for WCA330, RF1 and RF2 for WCA380)
Baseband attenuator	0 to 40 dB (1 dB step)
I/Q attenuator	0 to 30 dB (10 dB step)

Table B-4: Reference level

Characteristic	Description
Reference level setting range	-50 to +30 dBm (1 dB step, RF for WCA330, RF1 to RF4 for WCA380) -30 to +30 dBm (1 dB step, Baseband) -10 to +20 dBm (10 dB step, IQ)
Reference level accuracy	
at 20° C to 30° C	\pm 0.8 dB (Baseband) \pm 1.5 dB (RF for WCA330, RF1 for WCA380) \pm 1.5 dB (RF2, WCA380) \pm 2.0 dB (RF3, WCA380) \pm 2.0 dB (RF4, WCA380)
at 10° C to 40° C	\pm 1.0 dB (Baseband) \pm 2.0 dB (RF for WCA330, RF1 for WCA380) \pm 2.0 dB (RF2, WCA380) \pm 2.5 dB (RF3, WCA380) \pm 2.5 dB (RF4, WCA380)
Level linearity	\pm 0.2 dB (0 to -40 dBfs)

Table B-5: Dynamic range

Characteristic	Description
1 dB compression input	+2 dBm (RF attenuation = 0 dB)
3rd order intermodulation distortion	73 dBc (Hires IF mode, signal level ≤ -10 dBfs, 2 GHz) 70 dBc (Normal IF mode, signal level ≤ -10 dBfs, 2 GHz) 55 dBc (Wide IF mode, signal level ≤ -10 dBfs, 2 GHz)
Displayed average noise level (Typical)	
Baseband	-153 dBm/Hz (1 to 10 MHz)
Hires IF mode	-150 dBm/Hz (10 to 25 MHz) -147 dBm/Hz (25 M to 2.5 GHz) -145 dBm/Hz (2.5 to 3 GHz) -142 dBm/Hz (3 to 8 GHz, WCA380 only)
Normal IF mode	-147 dBm/Hz (10 to 25 MHz) -143 dBm/Hz (25 MHz to 2.5 GHz) -141 dBm/Hz (2.5 to 3 GHz) -140 dBm/Hz (3 to 8 GHz, WCA380 only)
Wide IF mode	-140 dBm/Hz (50 M to 3 GHz) -140 dBm/Hz (3 to 8 GHz, WCA380 only)
Spectrum due to modulation for GSM	80 dBc (30 kHz RBW, 1.2 MHz offset) 78 dBc (100 kHz RBW, 1.8 MHz offset)
Spectrum due to switching transient for GSM	78 dBc (30 kHz RBW, 1.2 MHz offset) 78 dBc (30 kHz RBW, 1.8 MHz offset)
ACPR (W-CDMA forward link, crest factor = 11dB)	65 dB (ACPR Configuration)

Table B-6: Spurious response (Typical)

Characteristic	Description
Image suppression	
1 st IF	75 dB (RF for WCA330, RF1 for WCA380, center 1.5 GHz, input 9.962 GHz) 75 dB (RF2, center 3 GHz, input 11.462 GHz, WCA380 only) 70 dB (RF3, center 5 GHz, input 5.842 GHz, WCA380 only) 70 dB (RF4, center 6.5 GHz, input 5.658 GHz, WCA380 only)
2 nd and 3 rd IF	80 dB (RF for WCA330, RF1 for WCA380, Normal/HiRes IF mode) 75 dB (RF2/3/4, Normal/Hires IF mode, WCA380 only) 60 dB (RF for WCA330, RF1 for WCA380, Wide IF) 53 dB (RF2/3/4, Wide IF, WCA380 only)
Alias suppression	65 dB (Baseband) 60 dB (IQ)

Table B-6: Spurious response (Typical) (Cont.)

Characteristic	Description
Residual response	
without signal, span ≤ 5 MHz, RBW = 30 kHz, averaged	-73 dBfs or -93 dBm whichever greater (Normal/HiRes IF) -73 dBfs or -93 dBm whichever greater (Baseband, >1 MHz)
Wide IF mode, without signal, RBW=100kHz, averaged	-55 dBfs or -85 dBm whichever greater (Within 10 minutes and $\pm 5^\circ$ C from acquisition start)
Spurious response	
Signal at center, 2 MHz span, averaged, Normal and HiRes IF mode	-70 dBc or -75 dBfs whichever greater (Offset > 400 kHz) -65 dBc or -70 dBfs whichever greater (50 kHz \leq offset \leq 400 kHz)
Signal at center, 10 MHz span, averaged, Wide IF mode	-60 dBc or -65 dBfs whichever greater (Offset > 400 kHz)
Sideband spurious due to I/Q imbalance (averaged)	-55 dBc (Wide IF mode) -60 dBc (Wide IF mode, within 1 hour and $\pm 5^\circ$ C from self IQ balance calibration)

Table B-7: Acquisition

Characteristic	Description
Acquisition mode	Roll, Block
Acquisition memory size	16 Mbytes
Memory configuration mode	Frequency, Dual, Zoom
Data samples in one frame	256 points (Frequency mode only) 1024 points (All modes)
Block size	1 to 16,000 frames (Frequency mode, 256 points) 1 to 4,000 frames (Frequency mode, 1024 points) 1 to 2,000 frames (Dual or Zoom mode)
A/D Converter	
Baseband, Normal IF, Hires IF	14 bits, 25.6 Msps
Wide IF, IQ	12 bits, 40.96 Msps \times 2 for I/Q each signal
Real-Time Span	5 MHz
Vector Span	30 MHz (Wide IF mode, IQ) 10 MHz (Baseband) 6 MHz (Normal IF mode) 5 MHz (HiRes IF mode)

Table B-8: Sampling rate

Characteristic	Description
Sampling rate — Baseband, Normal and Hires IF modes	
10 MHz span (Baseband)	12.8 Msps
6 MHz span (Normal IF mode, RF)	12.8 Msps
5 MHz span	6.4 Msps
2 MHz span	3.2 Msps
1 MHz span	1.6 Msps
500 kHz span	800 ksps
200 kHz span	320 ksps
100 kHz span	160 ksps
50 kHz span	80 ksps
20 kHz span	32 ksps
10 kHz span	16 ksps
5 kHz span	8 ksps
2 kHz span	3.2 ksps
1 kHz span	1.6 ksps
500 Hz span	800 sps
200 Hz span	320 sps
100 Hz span	160 sps
Sampling rate — Wide IF mode, IQ	
20 M to 30 MHz span	40.96 Msps
10 MHz span	20.48 Msps

Table B-9: Frame update time

Characteristic	Description
Minimum frame update time — Frequency mode	
10 MHz span (Baseband)	20 μ s (256 points), 80 μ s (1024 points)
500 k to 6 MHz span	20 μ s (256 points), 80 μ s (1024 points)
50 k to 200 kHz span	200 μ s (256, 1024 points)
5 k to 20 kHz span	2000 μ s (256, 1024 points)
500 to 2 kHz span	20 ms (256, 1024 points)
200 Hz span	50 ms (256, 1024 points)
100 Hz span	100 ms (256, 1024 points)
Minimum frame update time — Dual mode	
500 k to 6 MHz span	160 μ s
50 k to 500 kHz span	400 μ s
5 k to 20 kHz span	4 ms
500 to 2 kHz span	40 ms
200 Hz span	100 ms
100 Hz span	200 ms
Frame update time — Zoom, Baseband, Normal and HiRes IF modes	
5 MHz span	160 μ s
2 MHz span	320 μ s
1 MHz span	640 μ s
500 kHz span	1.28 ms
200 kHz span	3.2 ms
100 kHz span	6.4 ms
50 kHz span	12.8 ms
20 kHz span	32 ms
10 kHz span	64 ms
5 kHz span	128 ms
2 kHz span	320 ms
1 kHz span	640 ms
500 Hz span	1.28 s
200 Hz span	3.2 s
100 Hz span	6.4 s
Frame update time — Zoom, Wide IF mode, IQ	
30 MHz span	25 μ s
20 MHz span	25 μ s
10 MHz span	50 μ s

Table B-10: Digital demodulation

Characteristic	Description
Demodulator	
Carrier type	Continuous, Burst
Modulation format	BPSK, QPSK, $\pi/4$ Shift DQPSK, 8PSK, OQPSK, 16QAM, 64QAM, 256QAM, GMSK
Measurement filter	Root cosine
Reference filter	Cosine, Gauss
Filter parameter	α/BT : 0.0001 to 1, 0.0001 step
Maximum symbol rate	5.3 Msps (Baseband, Normal and HiRes IF modes); 20.48 Msps (IQ, Wide IF mode)
Standard setup	PDC, PHS, NADC, TETRA, GSM, CDPD, IS-95, T-53
Display format	
Vector diagram	Symbol/locus display, Frequency error measurement, Origin offset measurement
Constellation diagram	Symbol display, Frequency error measurement, Origin offset measurement
Eye diagram	I/Q/Trellis display (1 to 16 symbols)
Error vector diagram	EVM, Magnitude error, Phase error, Waveform quality (ρ) measurement
Symbol table	Binary, Octal, Hexadecimal
Error measurement accuracy	
PDC	EVM $\leq 1.2\%$, Mag error $\leq 1.0\%$, Phase error $\leq 0.8^\circ$ (100 kHz span)
PHS	EVM $\leq 1.4\%$, Mag error $\leq 1.2\%$, Phase error $\leq 0.8^\circ$ (1 MHz span)
GSM	EVM $\leq 1.8\%$, Mag error $\leq 1.2\%$, Phase error $\leq 1.0^\circ$ (1 MHz span)
64QAM, 5.3 Msps, 1 GHz carrier (Typical)	EVM $\leq 2.5\%$ (20 MHz span)
QPSK, 4.096 Msps, 2 GHz carrier (Typical)	EVM $\leq 2.5\%$ (20 MHz span)
QPSK, 16.384 Msps, 2 GHz carrier (Typical)	EVM $\leq 3.0\%$ (30 MHz span, $25^\circ\text{C} \pm 5^\circ\text{C}$)

Table B-11: Analog demodulation accuracy (Typical)

Characteristic	Description
AM demodulation accuracy	$\pm 2\%$ (-10 dBfs input at center, 10 to 60 % modulation depth)
PM demodulation accuracy	$\pm 3^\circ$ (-10 dBfs input at center)
FM demodulation accuracy	$\pm 1\%$ of span (-10 dBfs input at center)

Table B-12: Resolution bandwidth filter

Characteristic	Description
Filter shape	Gaussian, Rectangle, Root Nyquist
Frequency range	1 Hz to 10 MHz
Maximum span setting to activate RBW filter	50 MHz

Table B-13: Trigger

Characteristic	Description
Trigger mode	
Normal IF mode (Span ≤ 6 MHz) Hires IF mode (Span ≤ 5 MHz) Baseband	Auto, Normal, Quick, Delayed, Interval, Quick-interval, Timeout
Wide IF mode, IQ	Auto, Normal
Trigger source	Internal (Level comparator) External (TTL)
Internal trigger comparator data source	Frequency amplitude Time amplitude
External trigger threshold level	1.6 V
Pre/post trigger setting	Trigger position is settable within 0 % to 100 % of total data length
Frequency event trigger	
Mask resolution	1 bin
Level range	0 dBfs to -70 dBfs
Time Event Trigger	
Mask resolution	1 sample point
Level range	0 dBfs to -40 dBfs
External synchronization timing uncertainty	± 50 ns (20/30 MHz span of Wide IF mode) ± 100 ns (10 MHz span of Wide IF mode)

Table B-14: Display

Characteristic	Description
Display format	
Waveform	Frequency vs. Amplitude/Phase Frequency vs. I/Q voltage Time vs. Amplitude/Phase Time vs. I/Q voltage
Spectrogram	Time vs. Frequency vs. Amplitude/Phase
Waterfall	Time vs. Frequency vs. Amplitude/Phase Time vs. Frequency vs. I/Q voltage Time vs. Amplitude/Phase Multi-frame Time vs. I/Q voltage Multi-frame
AM demodulation	Time vs. Modulation depth
FM demodulation	Time vs. Frequency deviation
PM demodulation	Time vs. Phase deviation
FSK Demodulation	Time vs Frequency deviation
Polar	Vector diagram, Constellation diagram
Eye pattern	I eye pattern, Q eye pattern, Trellis
Symbol table	Binary, Octal, Hexadecimal
Error vector	EVM, Magnitude error, Phase error, Waveform quality (ρ)
View	
Number of views	1, 2, 4
Settable views	8 (Maximum)
Number of traces	2 (at the Waveform display)
LCD panel	
Size	30.7 cm (12.1 in)
Display resolution	1024 × 768 pixels
Color	256 colors (Maximum)

Table B-15: Marker

Characteristic	Description
Marker	
Type	Normal, Delta, Band-power
Search functions	Peak right, Peak left, Maximum
Link between views	On/Off
Measurement functions	Noise power, Power within band, C/N ratio, Adjacent channel power, Occupied bandwidth

Table B-16: Zoom

Characteristic	Description
Digital zoom ratio	2 to 1000
Maximum span at Zoom mode	5 MHz (Baseband, Normal and HiRes IF modes) 30 MHz (Wide IF mode, IQ)

Table B-17: Controller/Interface

Characteristic	Description
Controller	
CPU	Intel Celeron 433 MHz
DRAM	128 Mbyte DIMM
OS	Windows 98
System bus	PCI, ISA
Data storage	
Hard disk	40 Gbyte 3.5 inch IDE
Floppy disk	1.44 Mbyte 3.5 inch
Flash disk	8 Mbyte flash memory
Interface	
Printer port	Centronics parallel
GPIB	IEEE488.1
LAN	10/100 Base-T (IEEE802.3)
Mouse	PS-2
Keyboard	PC/AT
Monitor out	15-pin D-sub VGA connector

Table B-18: Power requirements

Characteristic	Description
Line voltage and frequency	100 to 240 VAC, 47 to 66 Hz
Line fuse	10 A
Primary circuit dielectric voltage withstand grounding impedance	1,500 Vrms, 50 Hz for 15 s, without breakdown. Verify continuity of grounding connection, by any suitable means, between a representative part required to be grounding and attachment- plug cap grounding pin. (0.1 Ω at 30 A)
Maximum power dissipation (fully loaded)	350 W max. Maximum line current is 5 Arms at 50Hz, 90V line, with 5% clipping.
Surge current	Maximum 30 A peak at 25° C for ≤ 5 line cycles, after product has been turned off for at least 30 s.

Physical Characteristics

Table B-19: Physical

Characteristic	Description
Width	430 mm (16.9 in) without belts
Height	270 mm (10.6 in) without feet
Length	600 mm (23.6 in) without connectors and fan cover
Net weight	31 kg

Environmental Characteristics

Table B-20: Environmental

Characteristic	Description
Temperature	
Operating	+5° C to +40° C (floppy not used); +10° C to +40° C (floppy in use)
Non-operating	-20° C to +60° C
Humidity	
Operating and non-operating	80 % (no condensation); Maximum wet-bulb temperature 29° C
Altitude	
Operating	To 3,000 m (10,000 ft)
Non-operating	To 12,000 m (40,000 ft)
Random vibration	
Operating	0.27 g, 5 to 500 Hz, 10 minutes each axis
Non-operating	2.28 g, 5 to 500 Hz, 10 minutes each axis
Shock	
Non-operating	20 g half-sine, 11 ms duration, 3 shocks per axis in each direction (18 shocks total)
Cooling clearance	
Bottom	20 mm (0.79 in)
Both sides	50 mm (1.97 in)
Rear	50 mm (1.97 in) from the rear fan cover

Table B-21: Certifications and compliances

Characteristic	Description
EC Declaration of Conformity – EMC	<p>Meets intent of Directive 89/336/EEC for Electromagnetic Compatibility. Compliance was demonstrated to the following specifications as listed in the Official Journal of the European Union:</p> <p>EN 55011 Class A Radiated and Conducted Emissions</p> <p>EN 50081-1 Emissions: EN 61000-3-2 AC Power Line Harmonic Emissions</p> <p>EN 50082-1 Immunity: EN61000-4-2 Electrostatic Discharge Immunity EN61000-4-3 RF Electromagnetic Field Immunity EN61000-4-4 Electrical Fast Transient/Burst Immunity EN61000-4-5 Power Line Surge Immunity EN61000-4-6 Conducted Disturbances Induced by RF Fields EN61000-4-8 Power Frequency Electromagnetic Field EN61000-4-11 Power Line Interruption Immunity</p>
Australia/New Zealand Declaration of Conformity – EMC	<p>Complies with EMC provision of Radiocommunications Act per the following standard(s):</p> <p>AS/NZS 2064.1/2 Industrial, Scientific, and Medical Equipment: 1992</p>
EC Declaration of Conformity – Low Voltage	<p>Compliance was demonstrated to the following specification as listed in the Official Journal of the European Union:</p> <p>Low Voltage Directive 73/23/EEC, amended by 93/69/EEC</p> <p>EN 61010-1:1993 Safety requirements for electrical equipment for measurement control and laboratory use.</p>
U.S. Nationally Recognized Testing Laboratory Listing	<p>UL3111-1 Standard for electrical measuring and test equipment.</p>
Canadian Certification	<p>CAN/CSA C22.2 No. 1010.1 CSA safety requirements for electrical and electronic measuring and test equipment.</p>
Additional Compliance	<p>ANSI/ISA S82.01:1994 Safety standard for electrical and electronic test, measuring, controlling, and related equipment.</p> <p>IEC61010-1 Safety requirements for electrical equipment for measurement, control, and laboratory use.</p>
Installation (Overvoltage) Category	<p>Terminals on this product may have different installation (overvoltage) category designations. The installation categories are:</p> <p>CAT III Distribution-level mains (usually permanently connected). Equipment at this level is typically in a fixed industrial location.</p> <p>CAT II Local-level mains (wall sockets). Equipment at this level includes appliances, portable tools, and similar products. Equipment is usually cord-connected.</p> <p>CAT I Secondary (signal level) or battery operated circuits of electronic equipment.</p>

Table B-21: Certifications and compliances (Cont.)

Characteristic	Description								
Pollution Degree	<p>A measure of the contaminates that could occur in the environment around and within a product. Typically the internal environment inside a product is considered to be the same as the external. Products should be used only in the environment for which they are rated.</p> <table border="0" data-bbox="605 541 1455 1079"> <tr> <td data-bbox="605 541 889 638">Pollution Degree 1</td> <td data-bbox="896 541 1455 638">No pollution or only dry, nonconductive pollution occurs. Products in this category are generally encapsulated, hermetically sealed, or located in clean rooms.</td> </tr> <tr> <td data-bbox="605 646 889 835">Pollution Degree 2</td> <td data-bbox="896 646 1455 835">Normally only dry, nonconductive pollution occurs. Occasionally a temporary conductivity that is caused by condensation must be expected. This location is a typical office/home environment. Temporary condensation occurs only when the product is out of service.</td> </tr> <tr> <td data-bbox="605 844 889 1003">Pollution Degree 3</td> <td data-bbox="896 844 1455 1003">Conductive pollution, or dry, nonconductive pollution that becomes conductive due to condensation. These are sheltered locations where neither temperature nor humidity is controlled. The area is protected from direct sunshine, rain, or direct wind.</td> </tr> <tr> <td data-bbox="605 1012 889 1079">Pollution Degree 4</td> <td data-bbox="896 1012 1455 1079">Pollution that generates persistent conductivity through conductive dust, rain, or snow. Typical outdoor locations.</td> </tr> </table>	Pollution Degree 1	No pollution or only dry, nonconductive pollution occurs. Products in this category are generally encapsulated, hermetically sealed, or located in clean rooms.	Pollution Degree 2	Normally only dry, nonconductive pollution occurs. Occasionally a temporary conductivity that is caused by condensation must be expected. This location is a typical office/home environment. Temporary condensation occurs only when the product is out of service.	Pollution Degree 3	Conductive pollution, or dry, nonconductive pollution that becomes conductive due to condensation. These are sheltered locations where neither temperature nor humidity is controlled. The area is protected from direct sunshine, rain, or direct wind.	Pollution Degree 4	Pollution that generates persistent conductivity through conductive dust, rain, or snow. Typical outdoor locations.
Pollution Degree 1	No pollution or only dry, nonconductive pollution occurs. Products in this category are generally encapsulated, hermetically sealed, or located in clean rooms.								
Pollution Degree 2	Normally only dry, nonconductive pollution occurs. Occasionally a temporary conductivity that is caused by condensation must be expected. This location is a typical office/home environment. Temporary condensation occurs only when the product is out of service.								
Pollution Degree 3	Conductive pollution, or dry, nonconductive pollution that becomes conductive due to condensation. These are sheltered locations where neither temperature nor humidity is controlled. The area is protected from direct sunshine, rain, or direct wind.								
Pollution Degree 4	Pollution that generates persistent conductivity through conductive dust, rain, or snow. Typical outdoor locations.								
Safety Certification Compliance									
Equipment Type	Test and measuring								
Safety Class	Class 1 (as defined in IEC 1010-1, Annex H) – grounded product								
Overvoltage Category	Overvoltage Category II (as defined in IEC 1010-1, Annex J)								
Pollution Degree	Pollution Degree 2 (as defined in IEC 1010-1). Note: Rated for indoor use only.								

Appendix C: Default Settings

The default settings of the basic configuration set by the CONFIG:MODE menu are shown in Table C-1 for the Standard configuration, Table C-2 for the CDMA configuration, and Table C-3 for the 3GPP configuration. Restoring the default settings is described at the end of this section.

Table C-1: Default settings for the Standard configuration

Menu	Item	Spectrum	Spectrum/ Spectro- gram	Dual	Zoom	Digital Demod	External Sync	RST 1
CONFIG	Setup	Standard	Standard	Standard	Standard	Standard	Standard	
	View A	Waveform	Waveform	Waveform	Waveform	Waveform	Waveform	
	View B	None	Spectrogram	Spectrogram	Spectrogram	Spectrogram	Spectrogram	
	View C	None	None	Waveform	Waveform	Polar	Waveform	
	View D	None	None	Waveform	Spectrogram	EyeDiagram	Waveform	
	Util D	None	None	None	None	None	Ext Sync	
	Util E	None	None	None	None	None	None	
	Util F	None	None	None	None	None	None	
SETUP	Util G	None	None	None	None	None	None	
	Band	RF/RF1	RF/RF1	RF/RF1	RF/RF1	RF/RF1	RF/RF1	✓
	IF Mode	Normal	Normal	Normal	Normal	Normal	Wide	✓
	Memory Mode	Frequency	Frequency	Dual	Zoom	Dual		
	Input Coupling	AC	AC	AC	AC	AC		
	FFT Window	Blackman	Blackman	Blackman	Blackman	Blackman		
	FFT Points	1024	1024	1024	1024	1024		
	Freq	1.5 GHz	1.5 GHz	1.5 GHz	1.5 GHz	1.5 GHz		✓
	Span	3 GHz	3 GHz	3 GHz	3 GHz	3 GHz		✓
	Ref	0 dBm	0 dBm	0 dBm	0 dBm	0 dBm		✓
	Reference Osc	Internal	Internal	Internal	Internal	Internal		
	Frequency Offset	0	0	0	0	0		
	Ref Offset	0	0	0	0	0		
	Frame Period	80 μ	160 μ	160 μ	80 μ	160 μ		
	Block Size	200	200	200	200	200		
	Trigger Mode	Auto	Auto	Auto	Auto	Auto	Normal	
	Trigger Count	On	On	On	On	On		
	Trigger Times	1	1	1	1	1		
	Trigger Domain	Frequency	Frequency	Frequency	Frequency	Frequency		
	Trigger Source	Internal	Internal	Internal	Internal	Internal	External	
	Trigger Slope	Rise	Rise	Rise	Rise	Rise		
	Trigger Position	50 %	50 %	50 %	50 %	50 %		
	Zoom Frequency				1.5 GHz ²			
	Zoom Span				3 GHz ²			
	Zoom Mag				2 ²			

Table C-1: Default settings for the Standard configuration (Cont.)

Menu	Item	Spectrum	Spectrum/ Spectro- gram	Dual	Zoom	Digital Demod	External Sync	RST 1
View A	Source	Active	Active	Active	Active	Active		
	Format	FreqAmpl	FreqAmpl	FreqAmpl	FreqAmpl	FreqAmpl		
	Frame	0	0	0	0	0		
	Display Lines...→Hor. 1 Visible	Off	Off	Off	Off	Off		
	Display Lines...→Hor. 1	0	0	0	0	0		
	Display Lines...→Hor. 2 Visible	Off	Off	Off	Off	Off		
	Display Lines...→Hor. 2	0	0	0	0	0		
	Display Lines...→Ver. 1 Visible	Off	Off	Off	Off	Off		
	Display Lines...→Ver. 1	0	0	0	0	0		
	Display Lines...→Ver. 2 Visible	Off	Off	Off	Off	Off		
	Display Lines...→Ver. 2	0	0	0	0	0		
	Scale...→Hor. Scale	3 GHz	3 GHz	3 GHz	3 GHz	3 GHz		
	Scale...→Hor. Start	0	0	0	0	0		
	Scale...→Ver. Scale	100 dBm	100 dBm	100 dBm	100 dBm	100 dBm		
	Scale...→Ver. Start	-100 dBm	-100 dBm	-100 dBm	-100 dBm	-100 dBm		
Trace2...→Source	None	None	None	None	None			
Trace2...→Format	FreqAmpl	FreqAmpl	FreqAmpl	FreqAmpl	FreqAmpl			
Trace2...→Frame	0	0	0	0	0			
View B	Source		Active	Active	Active	Active		
	Format		FreqAmpl	FreqAmpl	FreqAmpl	FreqAmpl		
	Scale...→Hor. Scale		3 GHz	3 GHz	3 GHz	3 GHz		
	Scale...→Hor. Start		0	0	0	0		
	Scale...→Ver. Scale		308	132	308	308		
	Scale...→Ver. Start		0	0	0	0		
	Scale...→Color Scale		100 dBm	100 dBm	100 dBm	100 dBm		
	Scale...→Color Start		-100 dBm	-100 dBm	-100 dBm	-100 dBm		
View C	Source			Active	Zoom	Active		
	Format			Timel	FreqAmpl	Vector	Timel	
	Frame			0	0			
	Display Lines...→Hor. 1 Visible			Off	Off			
	Display Lines...→Hor. 1			0	0			
	Display Lines...→Hor. 2 Visible			Off	Off			
	Display Lines...→Hor. 2			0	0			
	Display Lines...→Ver. 1 Visible			Off	Off			
	Display Lines...→Ver. 1			0	0			
	Display Lines...→Ver. 2 Visible			Off	Off			
	Display Lines...→Ver. 2			0	0			
	Scale...→Hor. Scale			-	-			
	Scale...→Hor. Start			-	-			
	Scale...→Ver. Scale			2 V	100 dBm			
Scale...→Ver. Start			-1 V	-100 dBm				

Table C-1: Default settings for the Standard configuration (Cont.)

Menu	Item	Spectrum	Spectrum/ Spectro- gram	Dual	Zoom	Digital Demod	External Sync	RST 1
	Burst...→Number Frames					1		
	Burst...→Search					Off		
	Burst...→Block Size					4		
	Burst...→Peak Threshold					-40		
	Burst...→Threshold					-20 dB		
	Burst...→Offset					0		
	Mask...→Mask					Off		
	Mask...→Marker Link					Off		
	Mask...→Center					0		
	Mask...→Width					0		
	Mask...→Left					0		
	Mask...→Right					0		
	Manual Setup...→Modulation					1/4 π QPSK		
	Manual Setup...→Symbol Rate					21 k		
	Manual Setup...→Filter					RootRaised- Cosine		
	Manual Setup...→Alpha/BT					0.5		
	Measurement Destination					D5D6		
	Reference Destination					D7D8		
View D	Source			Active	Zoom	Measurement		
	Format			TimeQ	FreqAmpl	I	TimeQ	
	Frame			0	0			
	Display Lines...→Hor. 1 Visible			Off				
	Display Lines...→Hor. 1			0				
	Display Lines...→Hor. 2 Visible			Off				
	Display Lines...→Hor. 2			0				
	Display Lines...→Ver. 1 Visible			Off				
	Display Lines...→Ver. 1			0				
	Display Lines...→Ver. 2 Visible			Off				
	Display Lines...→Ver. 2			0				
	Scale...→Hor. Scale					-		
	Scale...→Hor. Start					-		
	Scale...→Ver. Scale			2 V	308			
	Scale...→Ver. Start			-1 V	0			
	Scale...→Color Scale				100 dBm			
	Scale...→Color Start				-100 dBm			
	Eye Length					2	2	

¹ These items are not reset when you set the basic configuration pattern.

² These items are displayed in gray initially. When you set the span equal to 5 MHz or lower in Baseband mode, or equal to 10 MHz or lower in RF mode, these items are available.

Table C-2: Default settings for the CDMA configuration

Menu	Item	EVM/Rho	Spurious	Time Domain	RST ¹
CONFIG	Setup	CDMA	CDMA	CDMA	
	View1	CDMAWaveform	CDMAWaveform	CDMATime	
	View2	Spectrogram	CDMAWaveform	CDMATime	
	View3	CDMAPolar	None	None	
	View4	EVM	None	None	
SETUP	Standard	IS-95	IS-95	IS-95	✓
	Channel	777	777	777	✓
	Span	5 MHz	30 MHz	30 MHz	✓
	Ref	0 dBm	0 dBm	0 dBm	✓
	Reference Osc	Internal	Internal	Internal	
	Block Size	20	200	20	
	Trigger Mode	Auto	Auto	Normal	
	Trigger Count	Off	Off	Off	
	Trigger Times	1	1	1	
	Trigger Domain	Frequency	Frequency	Time	
	Trigger Source	Internal	Internal	Internal	
	Trigger Slope	Rise	Rise	Rise	
	Trigger Position	40 %	40 %	40 %	
	Trigger Level	-30 dB	-30 dB	-30 dB	
CDMA Waveform	Source	Active	Active		
	Format	FreqAmpl	FreqAmpl		
	Frame	0	0		
	Options...→Scale...→Hor. Scale	1	1		
	Options...→Scale...→Hor. Start	0	0		
	Options...→Scale...→Ver. Scale	1	1		
	Options...→Scale...→Ver. Start	0	0		
	Options...→Marker...→Hor.	0	0		
	Options...→Marker...→Delta Marker	Off	Off		
	Options...→Mask...→RBW 30k, Frequency1	900 kHz	900 kHz		
	Options...→Mask...→RBW 30 k, Level1	-42 dB	-42 dB		
	Options...→Mask...→RBW 30k, Frequency2	1.98 MHz	1.98 MHz		
	Options...→Mask...→RBW 30 k, Level2	-54 dB	-54 dB		
	Options...→Mask...→RBW 1 M, Frequency	1.385 MHz	1.385 MHz		
	Options...→Mask...→RBW 1 M, Level	-60 dBm	-60 dBm		
	Options...→Position	45 %	45 %		
	RBW	30 kHz	30 kHz		
	Measurement	Power	Spurious		
	Measurement Options...→OBW	99 %	99 %		
	Measurement Options...→Separation	2 %	2 %		
	Measurement Options...→Threshold	-100 dB	-100 dB		
	Measurement Options...→Sorted by	Frequency	Frequency		
	Measurement Options...→Spurious Search	On	On		
Measurement Options...→Standard	IS-95	IS-95			
Measurement Options...→Channel	777	777			

Table C-2: Default settings for the CDMA configuration (Cont.)

Menu	Item	EVM/Rho	Spurious	Time Domain	RST ¹
CDMATime	Source			Active	
	Block			0	
	Trace1 (Raw)			On	
	Trace2 (Average)			On	
	Options...→Scale...→Hor. Scale			1	
	Options...→Scale...→Hor. Start			0	
	Options...→Scale...→Ver. Scale			1	
	Options...→Scale...→Ver. Start			0	
	Options...→Mask...→Off Left			169 μ s	
	Options...→Mask...→On Left			175 μ s	
	Options...→Mask...→On Right			1.425 ms	
	Options...→Mask...→Off Right			1.431 ms	
	Options...→Mask...→Off Level			-20 dB	
	Options...→Mask...→On Level			-3 dB	
	Options...→Num Averages			100	
Options...→Position			0		
Spectrogram	Source	Active			
	Format	FreqAmpl			
	Marker	0			
	Ver. Start	0			
	Options...→Scale...→Hor. Scale	0			
	Options...→Scale...→Hor. Start	0			
	Options...→Scale...→Ver. Scale	1			
	Options...→Scale...→Ver. Start	0			
	Options...→Scale...→Color Scale	20			
	Options...→Scale...→Color Start	0			
CDMAPolar	Source	Active			
	Frame	0			
	Manual Setup...→Modulation	CDMA_OQPSK			
	Manual Setup...→Symbol Rate	1.2288 M			
	Manual Setup...→Measurement Filter	RootRaisedCosine			
	Manual Setup...→Reference Filter	Raised-Cosine			
	Manual Setup...→Alpha/BT	0.2			
	Display	Measurement			
	Format	Constellation			
	Marker	0			
	Options...→Measurement Destination	D5D6			
	Options...→Reference Destination	D7D8			
	Options...→Position	45 %			
EVM	Format	EVM			
	Options...→Scale...→Hor. Scale	1			
	Options...→Scale...→Hor. Start	0			
	Options...→Scale...→Ver. Scale	100 %			
	Options...→Scale...→Ver. Start	0 %			

¹ These items are not reset when you set the basic configuration.

Table C-3: Default settings for the 3GPP configuration

Menu	Item	ACP	Down Link	RST ¹
CONFIG	Setup	3gppACP	Standard	
	View A	3gppACPView	Waveform	
	View B	None	3gppSpectrogram	
	View C	None	3gppPolar	
	View D	None	3gppPower	
SETUP	Band	RF/RF1	RF/RF1	✓
	IF Mode	HiRes	Wide	✓
	Memory Mode	Dual	Zoom	
	Input Coupling	AC	AC	
	FFT Type	SW	SW	
	FFT Window	Blackman	Blackman	
	FFT Points	1024	1024	
	Freq	1.5 GHz	1.5 GHz	✓
	Span	15 MHz	10 MHz	✓
	Ref	0 dBm	0 dBm	✓
	Carrier Width	5 MHz		
	Manual	Mixer	Mixer	
	Mixer Level	-25 dBm	-25 dBm	
	RF Att	20 dB	20 dB	
	Reference Osc	Internal	Internal	
	Frequency Offset	0	0	
Ref Offset	0	0		
View A	Source	D5	Active	
	Format		FreqAmpl	
	Frame		0	
	Filter	Off		
	Average...→Average	Off	Off	
	Average...→Average Type	RMS Expo	RMS Expo	
	Average...→Num Averages	10	10	
	Average...→Begin Frame	0	0	
	Average...→End Frame	0	0	
	RBW...→RBW Calculation	Off	Off	
	RBW...→Alpha	0.5	0.5	
	RBW...→RBW		0	
	Edit...→Hor.		0	
	Edit...→Ver.		0	
	Trace2...→Source		None	
	Trace2...→Format		FreqAmpl	
	Trace2...→Frame		0	
	Options...→Position		100 %	
	Options...→Hold Ver. Scale	Off	Off	

Table C-3: Default settings for the 3GPP configuration (Cont.)

Menu	Item	ACP	Down Link	RST ¹
	Display Lines...→Hor. 1 Visible	Off	Off	
	Display Lines...→Hor. 1	0	0	
	Display Lines...→Hor. 2 Visible	Off	Off	
	Display Lines...→Hor. 2	0	0	
	Display Lines...→Ver. 1 Visible	Off	Off	
	Display Lines...→Ver. 1	0	0	
	Display Lines...→Ver. 2 Visible	Off	Off	
	Display Lines...→Ver. 2	0	0	
	Scale...→Hor. Scale	1	1	
	Scale...→Hor. Start	0	0	
	Scale...→Ver. Scale	0	0	
	Scale...→Ver. Start	0	0	
	Scale...→Frame Relative		Off	
	Marker...→Hor.	0	0	
	Marker...→Trace		Trace1	
	Marker...→Delta Marker	Off	Off	
	Marker...→Measurement	ACP	Off	
	Marker...→ACP...→Band Power Markers	Center		
	Marker...→ACP...→SP	5 MHz		
	Marker...→ACP...→BW	4.096 MHz		
	Marker...→ACP...→Filter	Off		
	Marker...→ACP...→Filter Alpha	0.22		
	Marker...→ACP...→Filter SP	5 MHz		
	Marker...→ACP...→Filter BW	4.096 MHz		
	Search...→Separation	2 %		
	Search...→Delta Marker	Off		
View B	Time Slot		0	
	Ver. Start		0	
	Symbol Rate		Composite	
	Scale...→Hor. Scale		64 ch	
	Scale...→Hor. Start		0	
	Scale...→Ver. Scale		1	
	Scale...→Ver. Start		0	
	Scale...→Color Scale		50 dB	
	Scale...→Color Start		-50 dB	
	Marker...→Hor.		34 ch	
	Marker...→Ver.		0	
	Marker...→Delta Marker		Off	
	Search...→Separation		2 %	
	Search...→Ver.		0	
	Search...→Delta Marker		Off	
	Options...→Monochrome		Off	
	Options...→Number Colors		100	

Table C-3: Default settings for the 3GPP configuration (Cont.)

Menu	Item	ACP	Down Link	RST ¹
View C	Source		Active	
	Analysis Time Slot		0	
	Standard...		W-CDMA	
	Manual Setup...→Modulation		W-CDMA	
	Manual Setup...→Chip Rate		3.84 M	
	Manual Setup...→Measurement Filter		RootRaisedCosine	
	Manual Setup...→Reference Filter		RaisedCosine	
	Manual Setup...→Alpha/BT		0.22	
	Manual Setup...→Auto Carrier		On	
	Options...→Time Slot		0	
	Options...→Short Code		34 ch	
	Options...→Display		Measurement	
	Options...→Format		Vector	
	Options...→Marker		0	
	Options...→Hide SCH Part		On	
Options...→Symbol Rate		15 k		
View D	X Axis		Short Code	
	Average		Off	
	Time Slot		0	
	Symbol Rate		Composite	
	Scale...→Hor. Scale		64 ch	
	Scale...→Hor. Start		0	
	Scale...→Ver. Scale		50 dB	
	Scale...→Ver. Start		-50 dB	
	Marker...→Hor.		19 ch	
	Marker...→Delta Marker		Off	
	Search...→Separation		2 %	
	Search...→Delta Marker		Off	

¹ These items are not reset when you set the basic configuration.

Restoring Default Settings

When you select a basic configuration from the CONFIG:MODE menu after you have changed some settings, the parameters indicated with the check mark (✓) in the **RST** column of Table C–1 to C–3 remain unchanged. Do the following steps to reset the analyzer to the default basic configuration.

For the Standard Configuration. Refer to Table C–1.

1. Press the CONFIG:MODE key on the front panel.
2. Press the side key targeting the basic configuration.

Set the parameters that are not reset.

3. Change the input mode:
 - a. Press the SETUP:MAIN key.
 - b. Press the **Band** side key to select **RF** (for WCA330) or **RF1** (for WCA380) with the general purpose knob.
 - c. Press the **IF Mode** side key to select **Normal** with the general purpose knob.
4. Set the frequency, span, and reference level:
 - a. Press the SETUP:FREQ key.
 - b. Press the **Span** side key to enter 1.5 GHz using the keypad.
 - c. Press the **Max Span** side key.
 - d. Press the **Ref** side key to enter 0 dBm using the keypad.

For the CDMA Configuration. Refer to Table C–2

1. Press the CONFIG:MODE key on the front panel.
2. Press the side key targeting the basic configuration.

Set the parameters that are not reset.

3. Set the frequency, span, and reference level:
 - a. Press SETUP:MAIN → **Freq, Span, Ref...**
 - b. Press the **Standard** side key to select **IS95** using the general purpose knob.
 - c. Press the **Channel** side key to enter **777** using the keypad.

- d. Press the **Span** side key to enter the following value using the keypad:
 - 5 MHz for EVM/Rho
 - 30 MHz for Spurious and Time Domain
- e. Press the **Ref** side key to enter 0 dBm using the keypad.

For the 3GPP Configuration. Refer to Table C-3.

1. Press the CONFIG:MODE key on the front panel.
2. Press the side key targeting the basic configuration.

Set the parameters that are not reset.

3. Change the input mode:
 - a. Press the SETUP:MAIN key.
 - b. Press the **Band** side key to select **RF** (for WCA330) or **RF1** (for WCA380) with the general purpose knob.
 - c. Press the **IF Mode** side key to select the following mode with the general purpose knob:
 - **HiRes** for ACP
 - **Wide** for Down Link
4. Set the frequency, span, and reference level:
 - a. Press the SETUP:FREQ key.
 - b. Press the **Span** side key to enter 1.5 GHz using the keypad.
 - c. Press the **Span** side key to enter the following value using the keypad:
 - 15 MHz for ACP
 - 10 MHz for Down Link
 - d. Press the **Ref** side key to enter 0 dBm using the keypad.

Appendix D: Frequency and Time Resolution

Table D-1 shows the relation between span, frame length, frame period, maximum measurement time, and frequency and time resolution.

Table D-1: Frequency and time resolution – IF mode: Normal, HiRes

Span (Hz)	Frame length (s)		Minimum frame period (s) ¹			Maximum measurement time (s) ²		Frequency resolution (Hz)		Time resolution (s)		The number of bins within a span	
			1024		256	Dual/ Zoom	1024	256	1024			256	
	1024	256	Freq	Dual	Freq					Freq ³	1024		256
>10 M ⁴	–	–	–	–	–	–	–	6.25 k	25 k	–	–	5	6
10 M ⁷	80 μ	20 μ	80 μ	160 μ	20 μ	320 m	–	12.5 k	50 k	78.125 n	12.8 M	801	201
6 M	80 μ	–	80 μ	160 μ	–	320 m	–	12.5 k	–	78.125 n	12.8 M	481	–
5 M	160 μ	40 μ	80 μ	160 μ	20 μ	640 m	320 m	6.25 k	25 k	156.25 n	6.4 M	801	201
2 M	320 μ	80 μ	80 μ	160 μ	20 μ	1.28	640 m	3.125 k	12.5 k	312.5 n	3.2 M	641	161
1 M	640 μ	160 μ	80 μ	160 μ	20 μ	2.56	1.28	1.5625 k	6.25 k	625 n	1.6 M	641	161
500 k	1.28 m	320 μ	80 μ	160 μ	20 μ	5.12	2.56	781.25	3.125 k	1.25 μ	800 k	641	161
200 k	3.2 m	800 μ	200 μ	400 μ	200 μ	12.8	6.4	312.5	1.25 k	3.125 μ	320 k	641	161
100 k	6.4 m	1.6 m	200 μ	400 μ	200 μ	25.6	12.8	156.25	625	6.25 μ	160 k	641	161
50 k	12.8 m	3.2 m	200 μ	400 μ	200 μ	51.2	25.6	78.125	312.5	12.5 μ	80 k	641	161
20 k	32 m	8 m	2 m	4 m	2 m	128	64	31.25	125	31.25 μ	32 k	641	161
10 k	64 m	16 m	2 m	4 m	2 m	256	128	15.625	62.5	62.5 μ	16 k	641	161
5 k	128 m	32 m	2 m	4 m	2 m	512	256	7.8125	31.25	125 μ	8 k	641	161
2 k	320 m	80 m	20 m	40 m	20 m	1280	640	3.125	12.5	312.5 μ	3.2 k	641	161
1 k	640 m	160 m	20 m	40 m	20 m	2560	1280	1.5625	6.25	625 μ	1.6 k	641	161
500	1.28	320 m	20 m	40 m	20 m	5120	2560	781.25 m	3.125	1.25 m	800	641	161
200	3.2	800 m	50 m	100 m	50 m	12800	6400	312.5 m	1.25	3.125 m	320	641	161
100	6.4	1.6	100 m	200 m	100 m	25600	12800	156.25 m	625 m	6.25 m	160	641	161

¹ The frame period is set with multiplying this value by an integer. Max. 60 s. Fixed in Zoom mode (= frame length). FFT is always running for each minimum frame period in the frequency mode.

² Measured with the setting of (frame period) = (frame length).

³ Rectangular of the FFT window is selected.

⁴ RF mode only. 1-2-5 steps in the range of 10 MHz to 3 GHz, plus 30 MHz and 3 GHz.

⁵ 800xN+1 (N = Span/5 MHz).

⁶ 200xN+1 (N = Span/5 MHz).

⁷ Baseband mode only.

Table D-2: Frequency and time resolution – IF mode: Wide ¹

Span (Hz)	Frame length (s)	Frame period (s) ²	Maximum measurement time (s)	Frequency resolution (Hz)	Time resolution (s)		The number of bins within a span
30 M	25 μ	25 μ	50 m	40 k	24.4140625 n	40.96 M	751
20 M	25 μ	25 μ	50 m	40 k	24.4140625 n	40.96 M	501
10 M	50 μ	50 μ	100 m	20 k	48.828125 n	20.48 M	501

¹ The FFT point is 1024 only.

² Frame period = Frame length (fixed in the Zoom mode).

Appendix E: Mouse Operations

With a mouse connected to the analyzer, you can perform all the menu operations for the analyzer. With a keyboard connected to the analyzer, you can more easily enter numeric values and file names.

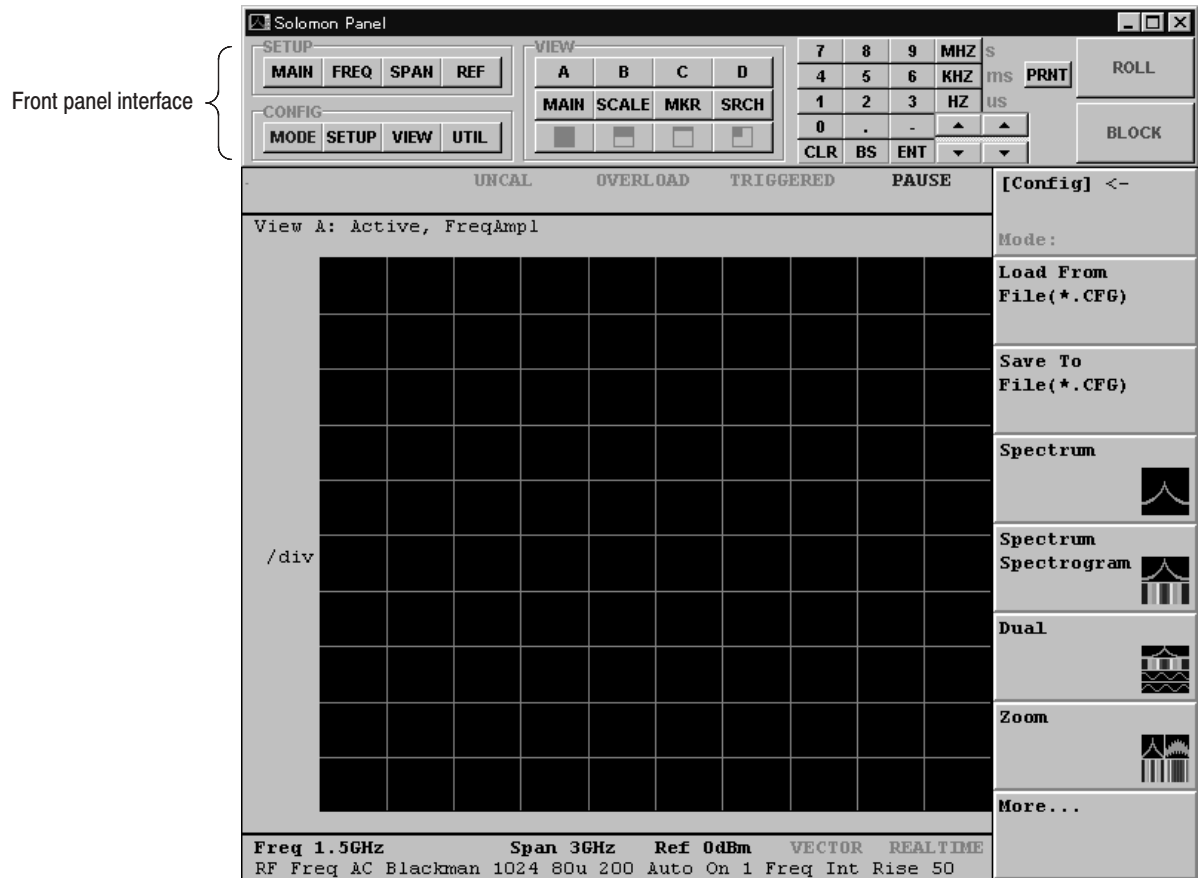

Figure E-1: Front panel interface for mouse operations

Displaying the Front Panel Interface

You can start the mouse operating software from the task bar or shortcut icon. Connect a mouse (and a keyboard if necessary) referring *Attaching a Mouse and a Keyboard* on page 3–195, then perform the following procedure.

Starting the Software from the Task Bar

1. Move the mouse pointer to the bottom of the screen. The Windows 98 task bar appears.
2. Right-click on the **Start** icon. A menu appears.
3. Select **Open** from the menu. The Start Menu window appears.
4. Double-click the **Programs** icon.
5. Right-click on the **WCA** icon. A menu appears.
6. Select **Properties** from the menu to open the property setting window.
7. Click on the **Shortcut** tab in the property setting window.
8. Select **Ordinary window** in the **Running size** field.
9. Click **OK**. The property setting window disappears.

The front panel interface will appear at the next startup and after. If you have created a WCA330 or WCA380 shortcut, also make the above setting.

To return to the initial condition (no front panel interface display), select **Minimum window** in step 8 above.

Starting the Software from the Shortcut Icon

1. Right-click on the shortcut icon. A menu appears.
2. Select **Properties** from the menu to open the property setting window.
3. Click on the **Shortcut** tab in the property setting window.
4. Select **Ordinary window** in the **Running size** field.
5. Click **OK**. The property setting window disappears.

The front panel interface will appear at the next startup and after.

To return to the initial condition (no front panel interface display), select **Minimum window** in step 4 above.

Mouse Operations

The mouse is available for the following operations:

- Operating the front panel key
- Operating the side menu
- Selecting the CONFIG, SETUP, or VIEW menu
- Moving the marker or selecting a frame

Operating the Front Panel Key

The buttons in the front panel interface are associated with the front panel keys. It does not have the function associated with the general purpose knob; however, a similar function is implemented using the key pad arrow keys.

Figure E-2 shows the corresponding front panel interface buttons and the front panel keys. For details on the operation, refer to *Menu Operations* on page 2-11.

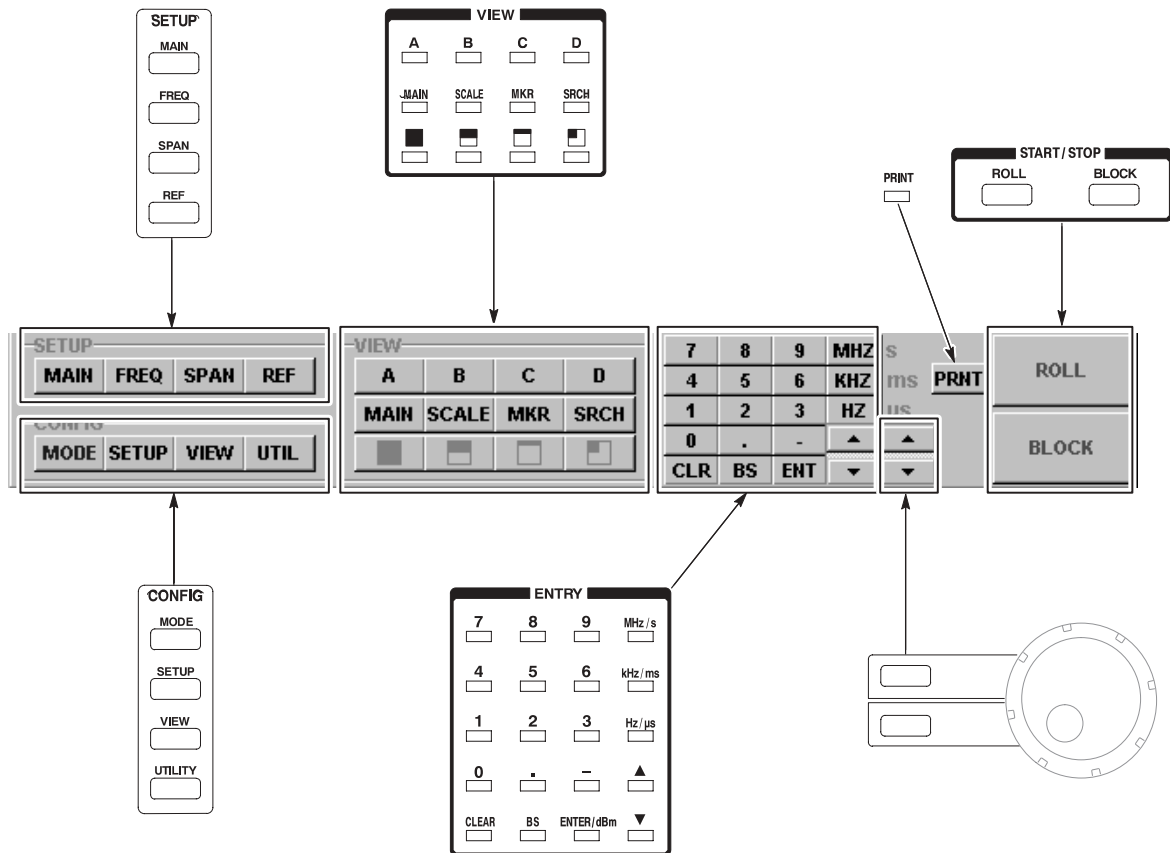

Keypad functions can be completed with the keyboard. Refer to *Operations with Keyboard* on page E-9.

Figure E-2: Correspondence between front panel interface buttons and front panel keys

Operating the Side Menu

Figures E-3 and E-4 summarize the side menu operations. The front panel keys and knob and the side keys also work while you are operating the mouse. However, the side keys are no longer associated with the menu on the screen.

For details on the operation, refer to *Menu Operations* on page 2-11.

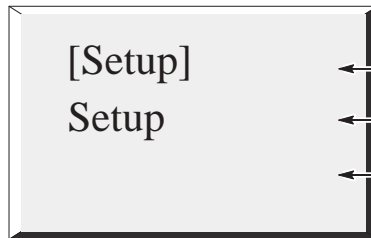
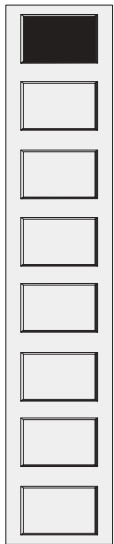

- ← Indicates that the top level menu is currently displayed.
- ← Currently displayed menu name.
- ← Displays nothing.

Even when you click this kind of menu item, no function executes. Operate with lower 7 menu items displayed.

To change the menu, use the CONFIG, SETUP, VIEW or PRINT keys on the front panel interface, or click a part of the displayed window, which is described in *Selecting the CONFIG, SETUP or VIEW Menu* on page E-7.



- ← Indicates that you can move to a higher menu level.
- ← Currently displayed menu name.
- ← Currently displayed submenu name.

Clicking this kind of menu item allows you to move to a higher menu level.

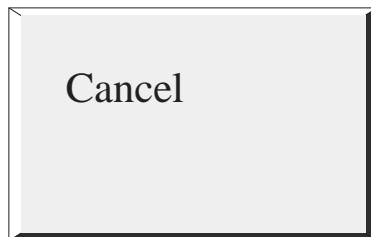

When you click this menu item, the menu currently displayed terminates and the menu previously displayed appears.

Figure E-3: Operating the side menu (top level item)

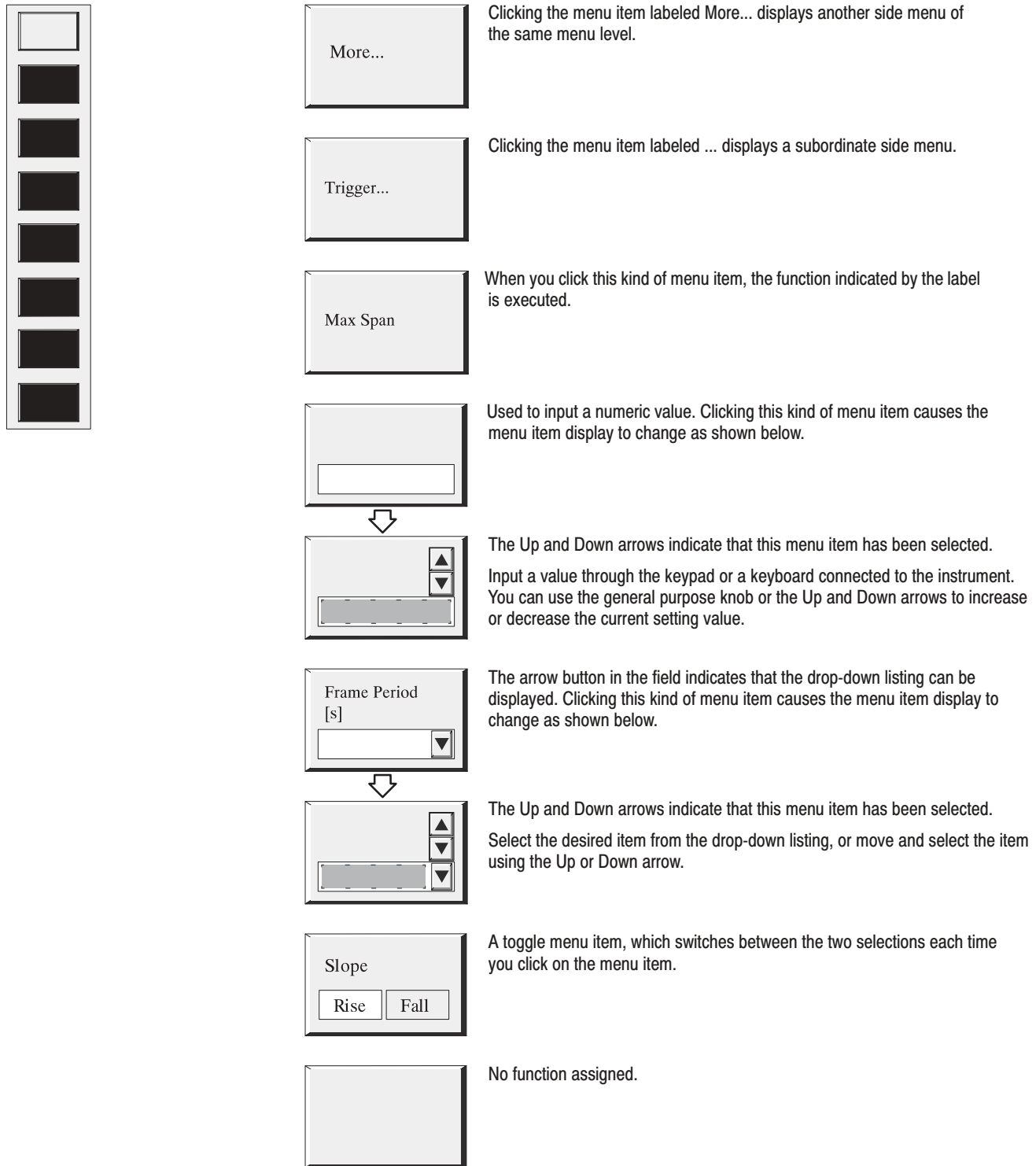

Figure E-4: Operating the side menu (7 items in lower level)

NOTE. When the instrument is used with the front panel interface in the open position, the side keys and corresponding side menu items are not in the same order as when the front panel interface is in the closed position.

Selecting the CONFIG, SETUP, or VIEW Menu

Another way to display the associated side menu is to click in any of the locations as shown in Figure E-5.

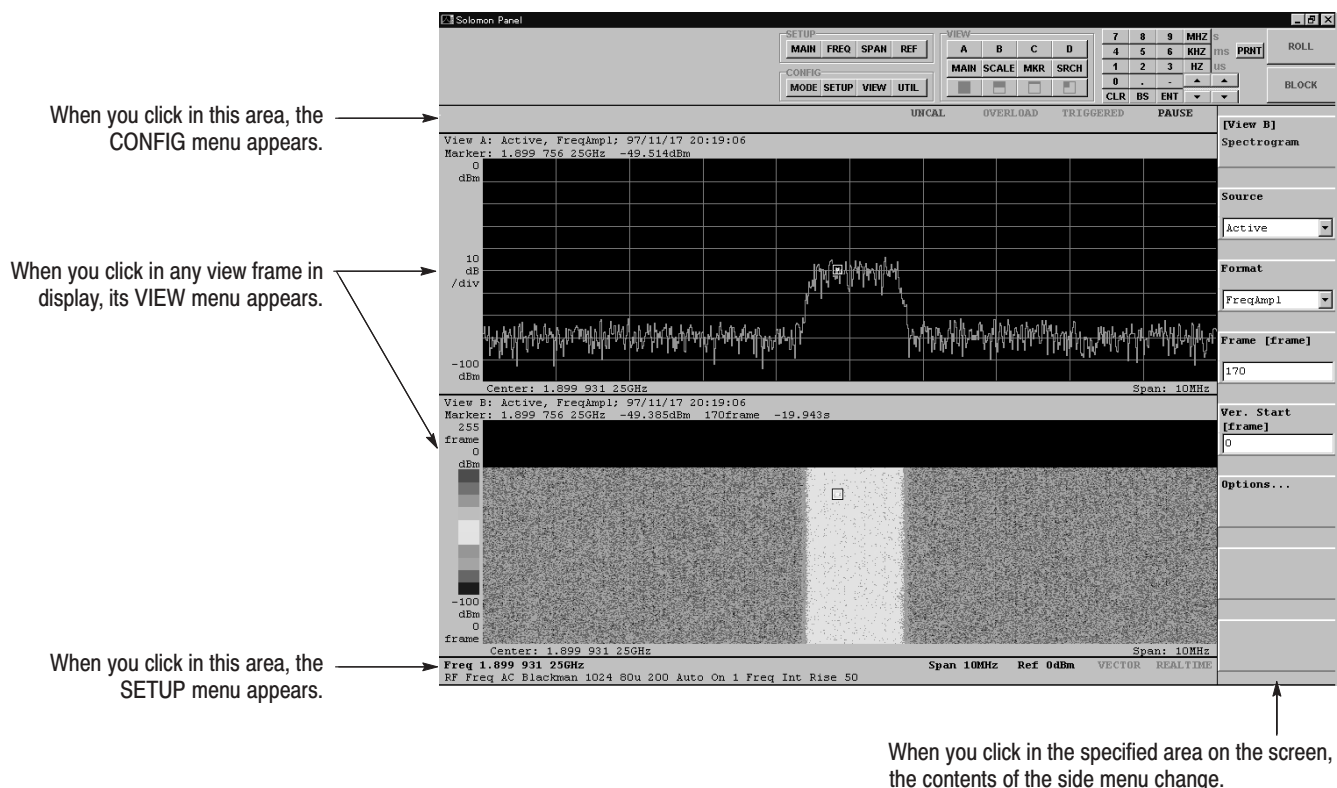

Figure E-5: Selecting menus using the mouse

Moving the Marker and Selecting a Frame

When you click on any point in the waveform display area, the primary marker moves as follows:

- In two-dimensional views such as the Waveform view, the marker moves on the waveform with the horizontal position determined by the click point.
- In three-dimensional views such as the Spectrogram view, the marker moves to the click point. The frame on which you click is selected. The associated two-dimensional view changes to the selected frame data.

You can also move the primary marker continuously by dragging it as follows:

1. Move the mouse pointer to the marker and press the left mouse button.
2. Move the pointer to the desired position while holding down the button, and then release it.

For the delta marker, you can move only the □ marker using the mouse. Refer to *Marker Operations and Peak Search* on page 3–45 and *Changing Display Frames* on page 3–38 for details.

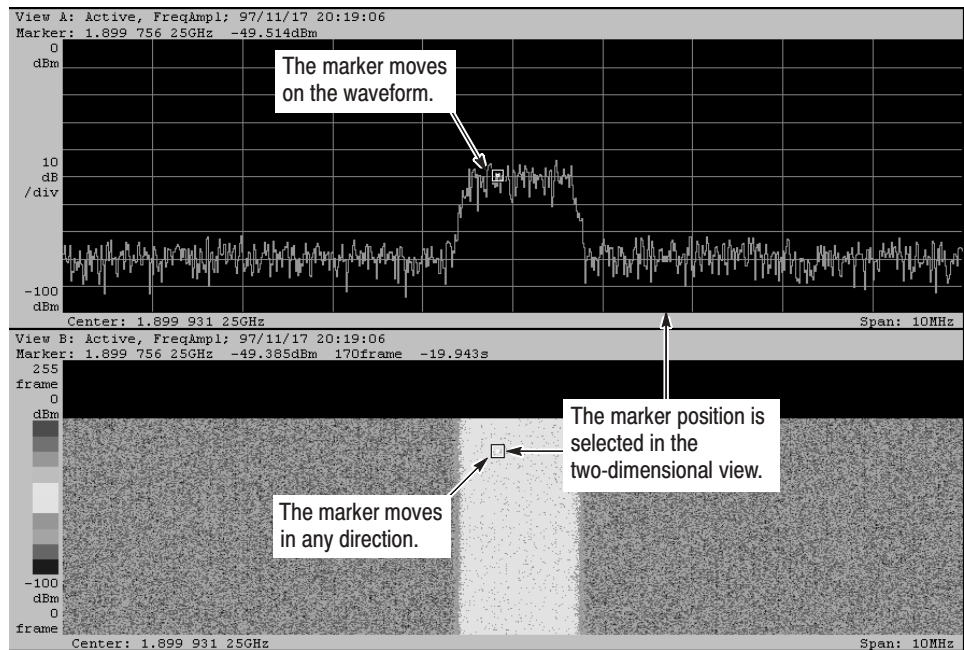

Figure E-6: Moving the marker and selecting a frame

Operations with Keyboard

The operations with the keypad on the front panel can be done by the keyboard. Table E-1 shows the mapping between the keypad and keyboard keys.

Table E-1: Mapping between keypad and keyboard keys

Keypad keys	Keyboard keys
0 to 9	0 to 9
CLR	ESC
BS	Back Space
ENT	ENTER
▲ and ▼	Up and Down arrows, respectively
Hz	ENTER
kHz	k and ENTER
MHz	M and ENTER
s	ENTER
ms	m and ENTER
μs	u and ENTER

Caution in Turning Off the Power

NOTE. When using the mouse, turn off the analyzer by placing the front-panel power switch in the **STANDBY** position. Do not use the Windows 98 shutdown process.

The analyzer normally controls the power not under the Windows 98 operating system but under the analyzer application software. So the shutdown process commonly used on Windows 98 is not effective in normal operation.

If you have performed the Windows 98 shutdown process:

The analyzer shuts down normally, but the front-panel power switch remains on with the STANDBY LED lit. At the next power-on, turn the power switch to STANDBY and back ON again.

Appendix F: Inspection and Cleaning

Inspect and clean the exterior of the instrument as often as operating conditions require. Dirt acts as an insulating blanket, preventing efficient heat dissipation. Regular cleaning may prevent instrument malfunction and enhance reliability.



WARNING. *To avoid injury or death, unplug the power cord from line voltage before cleaning the instrument. To avoid getting moisture inside the instrument during external cleaning, use only enough liquid to dampen the applicator.*

Inspection and Cleaning Procedures

If you need to clean the inside of the instrument, consult your Tektronix Service Center or representative. The collection of dirt on components inside can cause instrument overheating and breakdown. Dirt also provides an electrical conduction path that can cause instrument failure, especially under high-humidity conditions.



CAUTION. *Avoid the use of chemical cleaning agents that might damage the plastics used in this instrument. Organic solvents such as benzene and acetone must never be used.*

Inspecting Exterior

Inspect the outside of the instrument for damage, wear, and missing parts, using Table F-1 as a guide. Instruments that appear to have been dropped or otherwise abused should be checked thoroughly to verify correct operation and performance. Immediately repair defects that could cause personal injury or lead to further damage to the instrument.

Table F-1: External inspection check list

Item	Inspect for	Repair action
Cabinet, front panel, and cover	Cracks, scratches, deformations, damaged hardware or gaskets.	Contact your local Tektronix distributor or sales office.
Front-panel knobs	Missing, damaged, or loose knobs.	
Connectors	Broken shells, cracked insulation, and deformed contacts. Dirt in connectors.	
Carrying handle, bail, cabinet feet.	Correct operation.	
Accessories	Missing items or parts of items, bent pins, broken or frayed cables, and damaged connectors.	

Cleaning Exterior

Clean the exterior of the instrument as follows:



CAUTION. *To prevent moisture from entering the instrument during external cleaning, use only enough liquid to dampen the cloth or applicator.*

1. Remove loose dust on the outside of the instrument with a lint free cloth.
2. Remove remaining dirt with a lint free cloth dampened in a general purpose detergent-and-water solution. Do not use abrasive cleaners.
3. Clean the monitor screen with a lint-free cloth dampened with either isopropyl alcohol or, preferably, a gentle, general purpose detergent-and-water solution.

Lubrication

There is no periodic lubrication required for this instrument.

Cleaning Inside

Consult your Tektronix Service Center or representative for cleaning the instrument interior.

Index

Index

Symbols

.AP, file extension, 3-174
.CFG, file extension, 3-174
.IQ, file extension, 3-174
.IQT, file extension, 3-172

Numbers

3GPP analysis
 ACP measurement, 3-149
 down-link signal, 3-143
3gppACPView menu table, 2-100
3gppPolar view menu table, 2-104
3gppPower view menu table, 2-106
3gppSpectrogram view menu table, 2-103

A

AC inlet, rear panel, 2-4
Accessories, A-1
 optional, A-2
 standard, A-2
ACP, power measurement, 3-86
ACP measurement, 3GPP, 3-149
Acquisition, 3-21
 start/stop, 3-23
Address, Tektronix, xxi
Adjusting the display tilt angle, 1-15
Analog modulated signal, analysis, 3-95
Analog view menu table, 2-69
Analysis
 3GPP, 3-143
 analog modulation, 3-95
 CCDF, 3-165
 CDMA, 3-111
 cdmaOne, 3-127
 digital modulation, 3-97
 FSK signal, 3-109
 GSM, 3-151
 power, 3-81
 W-CDMA, 3-135
Architecture, 1-4
Auto, trigger mode, 3-66
Auto-save function, 3-169
Auto-scale, 3-36
Average
 description, 3-57
 mode, 3-60

 operation, 3-61
 process, 3-58
 using the utility menu, 3-59
Average (Util C) menu table, 2-118

B

Backing up user files, 1-18
Band
 selection, 3-2
 setting, 3-6
Band power marker, operation, 3-90
Basband mode, description, 3-3
Base line, trigger mask pattern, 3-79
Bin, description, 3-41
Block mode, description, 3-21
Block size, setting, 3-22
Buffering the input value, 3-11

C

C/N, power measurement, 3-85
C/No, power measurement, 3-85
Calibration, 1-19
 IQ offset, 1-21
 self gain-calibration, 1-20
 wide IQ balance, 1-21
 wide IQ full calibration, 1-22
CCDF analysis, 3-165
CCDF menu table, 2-112
CCDFView menu table, 2-114, 2-115
CDMA analysis, 3-111
 modulation precision, 3-112
 spurious, 3-116
 time characteristics, 3-122
 waveform quality, 3-112
cdmaOne analysis, 3-127
CDMAPolar view menu table, 2-86
CDMATime view menu table, 2-88
CDMAWaveform view menu table, 2-83
Center frequency, setting with the search function,
 3-56
Changing display frames, 3-38
Changing the power-up settings, 2-121
Characteristics
 check, 1-25
 electrical, B-2
 Environmental, B-12
 Physical, B-12

- Cleaning, F-1
- Clock in/out connectors, rear panel, 2-4
- Code-domain power measurement
 - 3GPP, 3-145
 - cdmaOne, 3-129
 - W-CDMA, 3-137
- CodePolar view menu table, 2-92
- CodePower view menu table, 2-93
- CodeSpectrogram view menu table, 2-90
- CodeWPolar view menu table, 2-97
- CodeWPower view menu table, 2-99
- CodeWSpectrogram view menu table, 2-95
- Compression, description, 3-42
- CONFIG area, front panel, 2-3
- CONFIG menu table, 2-48
- Connection
 - keyboard, 3-195
 - LAN, 3-199
 - mouse, 1-11, 3-195
 - power cord, 1-10
 - printer, 3-202
- Constellation display, 3-102
- Contacting Tektronix, xxi
- Conventions, xx
- Copy, file, 3-181
- Correction data block, 3-194
- Count, trigger, 3-70
- Creating a trigger mask pattern, 3-75

D

- Data
 - block, 3-189
 - file format, 3-184
 - frame, 3-191
- Date, setting, 3-209
- Default settings, C-1
 - restore, C-9
- Delayed, trigger mode, 3-67
- Delete, file, 3-181
- Delta marker, operation, 3-48
- Diagnostics, 1-19
 - procedure, 1-23
- Difference between WCA 330 and WCA 380, 1-3
- Digital modulated signal, analysis, 3-97
- Display
 - adjusting the tilt angle, 1-15
 - analog demodulation, 3-96
 - constellation, 3-102
 - error vector analysis, 3-106
 - eye diagram, 3-104
 - front panel, 2-2

- FSK, 3-110
 - menu, 2-11
 - self test result, 3-211
 - setup, 2-9
 - status, 2-7
 - symbol table, 3-105
 - vector, 3-102
 - version, 3-211
 - waveform data, 3-31
- Documentation list, xx
- Domain, trigger, 3-73
- Down-link
 - 3GPP, 3-143
 - cdmaOne, 3-127
 - W-CDMA, 3-135
- Dual mode, description, 3-5

E

- Electrical characteristics, B-2
- ENTRY keypad, front panel, 2-3
- Environmental Characteristics, B-12
- Error vector analysis display, 3-106
- Ethernet, connection, 3-199
- EVM
 - description, 3-106
 - EVM view, 3-107
 - view menu table, 2-81
- Exhaust fan, rear panel, 2-4
- Expansion slot, rear panel, 2-4
- External trigger input connector, front panel, 2-3
- Eye diagram display, 3-104
- EyeDiagram view menu table, 2-79

F

- Features, overview, 1-2
- FFT
 - parameters, 3-15
 - points, 3-16
 - setting the parameters, 3-19
 - type, 3-16
 - window, 3-17
- File
 - access menu operations, 3-178
 - access menu table, 2-119
 - copy, 3-181
 - delete, 3-181
 - extension, 3-174
 - format, 3-184
 - header, 3-185

- name entry, 3–183
- operations, 3–173
- File extension, .IQT, 3–172
- Floppy disk drive, front panel, 2–2
- Format, data file, 3–184
- Four-view display, 3–35
- Frame
 - data, 3–191
 - header, 3–189
 - period, 3–25
 - relation among frame, bin, and pixel, 3–41
- Frame period table, 3–29
- Frequency
 - error, Polar view, 3–103
 - mode, 3–5
 - resolution, D–1
 - setting, 3–9
 - setting with the marker and search, 3–11
- Front panel
 - CONFIG area, 2–3
 - display, 2–2
 - ENTRY keypad, 2–3
 - external trigger input connector, 2–3
 - floppy disk drive, 2–2
 - general purpose knob, 2–3
 - PRINT key, 2–3
 - RF input connector, 2–3
 - SETUP area, 2–3
 - side keys, 2–2, 2–5
 - STANDBYLED indicator, 2–2
 - START/STOP keys, 2–3
 - step keys, 2–3
 - switch, 2–2
 - VIEW area, 2–3
- FSK
 - analysis, 3–109
 - view menu table, 2–71

G

- General purpose knob, front panel, 2–3
- GPIB connector, rear panel, 2–4
- GSM analysis, 3–151
- GSM view menu table, 2–107
- GSMMask view menu table, 2–111
- GSMPolar view menu table, 2–108

H

- Hardcopy
 - to a file, 3–205
 - to a printer, 3–202

- Header, frame, 3–189
- HiRes mode, description, 3–4

I

- I/Q input connectors, rear panel, 2–4
- IF mode
 - selection, 3–4
 - setting, 3–6
- Initial screen, power on, 1–14
- Input mode, 3–1
- Inspection, F–1
 - installation, 1–9
- Installation, 1–9
 - other applications, 1–18
 - power off, 1–16
 - trouble, 1–17
- Interface maps, 2–1
- Interval, trigger mode, 3–68
- IQ mode, description, 3–3
- IQ offset calibration, 1–21

K

- Keyboard
 - connection, 3–195
 - operation, E–9
- Keyboard interface connector, rear panel, 2–4

L

- LAN
 - connection, 3–199
 - connector, rear panel, 2–4
- Line marker, menu, 2–65
- Link
 - Marker, 3–40
 - view, 3–40
- Loading a file, 3–174
- LOCAL key, front panel, 2–3

M

- Mag error, EVM view, 3–107
- Manuals list, xx
- Marker
 - band power markers, 3–90
 - link, 3–40
 - operation, 3–45
 - type, 3–45
- Memory mode, 3–1

- selection, 3–5
- setting, 3–6
- Menu
 - display, 2–11
 - functions, 2–47
 - item information, 2–14
 - numeric input, 2–16
 - operations, 2–11
 - selection, 2–16
- Menu display area, screen, 2–5
- Menu table
 - 3gppACPView, 2–100
 - 3gppPolar view, 2–104
 - 3gppPower view, 2–106
 - 3gppSpectrogram view, 2–103
 - Analog view, 2–69
 - Average (Util C), 2–118
 - CCDF, 2–112
 - CCDFView, 2–114, 2–115
 - CDMAPolar view, 2–86
 - CDMATime view, 2–88
 - CDMAWaveform view, 2–83
 - CodePolar view, 2–92
 - CodePower view, 2–93
 - CodeSpectrogram view, 2–90
 - CodeWPolar view, 2–97
 - CodeWPower view, 2–99
 - CodeWSpectrogram view, 2–95
 - CONFIG, 2–48
 - EVM view, 2–81
 - EyeDiagram view, 2–79
 - file access, 2–119
 - FSK view, 2–71
 - GSM view, 2–107
 - GSMMask view menu, 2–111
 - GSM Polar view menu, 2–108
 - Polar view, 2–76
 - Print, 2–120
 - SaveLoad (Util B), 2–117
 - SelfCal (Util A), 2–116
 - SETUP (CDMA), 2–59
 - SETUP (Standard), 2–54, 2–61
 - Spectrogram view, 2–72
 - SymbolTable view, 2–80
 - Waterfall view, 2–75
 - Waveform view, 2–63
- Minimum frame period, 3–29
- Mode, trigger, 3–66
- Modulation system, supported, 3–98
- Mouse
 - connection, 1–11, 3–195
 - connector, rear panel, 2–4
 - operation, E–1

N

- Never, trigger mode, 3–69
- New clock settings dialog box, 1–13
- Noise, power measurement, 3–83
- Normal
 - IF mode, 3–4
 - trigger mode, 3–66
- Numeric input, 2–16

O

- OBW, power measurement, 3–88
- One-view display, 3–34
- Operation
 - average, 3–61
 - delta marker, 3–48
 - file access menu, 3–178
 - Keyboard, E–9
 - marker, 3–45
 - only with a mouse, E–1
 - peak search, 3–45
 - zoom, 3–54
- Operations, menu, 2–11
- Optional accessories, A–2
- Options, A–1
- Origin offset, Polar view, 3–103
- Output
 - spectrum data in the text format, 3–206
 - waveform data, 3–201
- OVERLOAD, status display, 2–8
- Overload
 - description, 3–14
 - indicator, 3–14
- Overview
 - features, 1–2
 - product, 1–1

P

- Parallel port, rear panel, 2–4
- PAUSE, status display, 2–8
- Peak hold, description, 3–57
- Peak search, operation, 3–45
- Phase error, EVM view, 3–107
- Phone number, Tektronix, xxi
- Physical Characteristics, B–12
- Pixel, relation among frame, bin, and pixel, 3–41
- Polar view menu table, 2–76
- Position, trigger, 3–74
- Power, power measurement, 3–84
- Power cord

- connection, 1–10
- option, A–1
- Power measurement, 3–81
 - ACP, 3–86
 - C/N, 3–85
 - C/No, 3–85
 - noise, 3–83
 - OBW, 3–88
 - power, 3–84
- Power off, installation, 1–16
- Power on, 1–9
 - procedure, 1–11
 - scan disk, 1–17
- Power switch
 - front panel, 2–2
 - turning on, 1–12
- Principal power switch
 - rear panel, 2–4
 - turning on, 1–12
- PRINT key, front panel, 2–3
- Print menu table, 2–120
- Printer
 - connection, 3–202
 - installing a driver, 3–203
 - outputting data, 3–202
- Process flow, digital modulation signal, 3–98
- Product support, contact information, xxi

Q

- Quick, trigger mode, 3–68
- Quick interval, trigger mode, 3–69

R

- Rackmount, Options, A–1
- Range, zoom, 3–53
- Real time, description, 3–25
- Rear panel
 - AC inlet, 2–4
 - clock in/out connectors, 2–4
 - exhaust fan, 2–4
 - expansion slot, 2–4
 - GPIB connector, 2–4
 - I/Q input connectors, 2–4
 - keyboard interface connector, 2–4
 - LAN interface connector, 2–4
 - mouse interface connector, 2–4
 - parallel port, 2–4
 - principal power switch, 2–4
 - VGA output port, 2–4
- Reference level, description, 3–13

- REMOTE, status display, 2–8
- Resolution
 - frequency, D–1
 - time, D–1
- Restoring default settings, C–9
- Restoring the factory default, 2–121
- RF input connector, front panel, 2–3
- RF mode, description, 3–3
- Rho meter, EVM view, 3–107
- RMS, description, 3–60
- RMSEXP, description, 3–60
- Roll mode, description, 3–21

S

- SaveLoad (Util B) menu table, 2–117
- Saving a file, 3–174
- Scalar mode, description, 3–5
- Scale, setting, 3–36
- Scan disk, power on, 1–17
- Screen hardcopy, 3–202
- SEAMLESS, status display, 2–8
- Seamless acquisition, description, 3–26
- Search, operation, 3–45
- Self gain-calibration, 1–20
- Self test
 - at power on, 1–13
 - displaying the result, 3–211
- SelfCal (Util A) menu table, 2–116
- Service support, contact information, xxi
- Setting
 - analog demodulation, 3–95
 - band, 3–6
 - block size, 3–22
 - date, 3–209
 - default, C–1
 - digital demodulation, 3–100
 - FFT parameters, 3–19
 - frame period, 3–25
 - Frequency, 3–9
 - FSK, 3–109
 - IF mode, 3–6
 - Memory mode, 3–6
 - reference level, 3–13
 - scale, 3–36
 - span, 3–9
 - time, 3–209
 - trigger, 3–66
 - view, 3–32
- SETUP (CDMA) menu table, 2–59
- SETUP (Standard) menu table, 2–54, 2–61
- SETUP area, front panel, 2–3

- Setup display, 2–9
- Setup sequence, 2–47
- Setup/status display area, screen, 2–5
- Side keys, front panel, 2–2, 2–5
- Slope, trigger, 3–73
- Source, trigger, 3–73
- Span, setting, 3–9
- Specifications, B–1
- Specified line, CDMA, 3–119
- Spectrogram view menu table, 2–72
- Spurious, CDMA analysis, 3–116
- Standard accessories, A–2
- STANDBY LED indicator, front panel, 2–2
- Start acquisition, 3–23
- START/STOP keys, front panel, 2–3
- Status display, 2–7
- Status display area, screen, 2–5
- Step keys, front panel, 2–3
- Stop acquisition, 3–23
- Symbol table display, 3–105
- SymbolTable view menu table, 2–80
- Sync word, entry, 3–163

T

- Targets of the product, 1–3
- Technical support, contact information, xxi
- Tektronix, contacting, xxi
- Text format, outputting spectrum data, 3–206
- Time, resolution, D–1
- Time characteristics, CDMA analysis, 3–122
- Timeout, trigger mode, 3–67
- Trigger
 - count, 3–70
 - description, 3–65
 - domain, 3–73
 - mask pattern, 3–75
 - mode, 3–66
 - position, 3–74
 - setting, 3–66
 - slope, 3–73
 - source, 3–73
- TRIGGERED, status display, 2–8
- Trouble, installation, 1–17
- Tutorial, 2–19

- Two-view display, 3–34

U

- UNCAL, status display, 2–8
- Unpacking, installation, 1–9
- URL, Tektronix, xxi

V

- VECTOR, status display, 2–8
- Vector display, 3–102
- Version, display, 3–211
- VGA output port, rear panel, 2–4
- View
 - general display information, 2–6
 - link, 3–40
 - setting, 3–32
- VIEW area, front panel, 2–3
- View display area, screen, 2–5

W

- Waterfall view menu table, 2–75
- Waveform view menu table, 2–63
- W-CDMA analysis, 3–135
- Web site address, Tektronix, xxi
- Wide IQ balance calibration, 1–21
- Wide IQ full calibration, 1–22
- Wide mode, description, 3–4
- Windows 98
 - access, 3–197
 - displaying the desktop screen, 3–198
 - starting applications, 3–197
 - use, 3–195
- Wireless communication analyzer, description, 1–1

Z

- Zoom
 - description, 3–51
 - mode, 3–6
 - operation, 3–54
 - range, 3–53

